

THE PREPARATORY MANUAL OF EXPLOSIVES

A LABORATORY MANUAL

Jared B. Ledgard, A.A.S., B.S., M.A.

*Organic chemist, Inventor
Seattle, Washington USA*

Contents

Section I:	
Introduction	page 1
Chapter 1	page 1
Chemical bonding: oxidation states	page 1
Ionic compounds and ionic bonds	page 2
Covalent compounds and covalent bonds	page 3
Understanding chemical structures and formulas	page 4
Chemical reactions	page 6
Language of chemistry	page 6
Conversion factors	page 7
Section II:	
Tutorial	page 9
Chapter 2	page 9
Lab safety	page 9
Laboratory equipment	page 10
Methods of heating	page 11
Methods of cooling	page 13
Extraction	page 15
Recrystallization, product recovery, and filtration	page 17
Washing liquid and solids	page 20
Drying agents, and drying liquids	page 21
Distillation	page 22
Final lesson: A tutorial on explosives	page 24
The dynamics of detonation	page 25
Detonation versus deflagration and combustion	page 26
Primary, and secondary explosives	page 27
Initiation of explosives	page 28
The power of explosives	page 29
The physical effects of explosives	page 30
Section III:	
Chemical reagents, intermediates, and solvents	page 32
Chapter 3	page 32
Section IV:	
Explosives and explosive compositions	page 65
Chapter 4: The preparation of metal azide, fulminates, and nitrides	page 66
4-01. AZ AZ Ammonium azide	page 66
4-02. CZ Cupric azide	page 67
CZ rim fire composition	page 68
4-03. SZ Silver azide	page 68
4-04. MZ Mercury azide	page 69
4-05. LZ Lead azide	page 70
4-06. Mercury fulminate	page 71
Priming mixture	page 72
Gunpowder	page 72
Rim fire composition	page 72
Rim fire composition	page 72
Initiating mixture	page 73
4-07. Silver fulminate	page 73
Priming mixture	page 74
4-08. Copper fulminate	page 74
4-09. Silver nitride	page 75
4-10. Mercury nitride	page 75
4-11. Sulfur nitride	page 77
Chapter 5: Preparation of Azides and azo nitros	page 80
5-01. BDPF Bis(1,3-diazo-2-propyl)formal	page 80

CONTENTS

5-02. TETRAZIDE Isocyanogen tetraazide	page 82
5-03. TAEN Triazoethanol nitrate	page 83
TAEN dynamite composition	page 84
5-04. AZIDOETHYL Tris(2-azidoethyl)amine	page 84
5-05. DANP 1,3-Diazido-2-nitrazapropane	page 86
DANP explosive composition	page 88
5-06. DIANP 1,5-diazido-3-nitrazapentane	page 89
DIANP propellant	page 90
5-07. Diazodinitrophenol 4,6,-Dinitro-2-diazophenol	page 91
5-08. HNTCAB Hexanitrotetrachloroazobenzene; 2,4,6,2',4',6'-Hexanitro-3,5,3',5'- tetrachloroazobenzene	page 94
5-09. DNAT 1,1'-dinitro-3,3'-azo-1,2,4-triazole	page 96
5-10. ADNB 4-Azido-4,4-dinitro-1-butyl acetate	page 98
5-11. ADBN. 4-Azido-4,4-dinitro-1-butyl nitrate	page 100
Chapter 6: The preparation of aza/oxa nitramines	page 103
6-01. TNTC. 2,4,6-trinitro-2,4,6-triazacyclohexanone	page 103
Azadine explosive composition	page 105
TNTC plastic explosive	page 105
6-02. DDD. 5,7-dinitro-5,7-diaza-1,3-dioxabicyclo[3:3:0] octan-2-one	page 105
DDD composition	page 107
6-03. TEX. 4,10-dinitro-2,6,8-12-tetraoxa-4,10-diazatetracyclo- [5.5.0.0.5,903,11]-dodecane	page 107
6-04. DNFA-P. 1,4-dinitrofurazano[3,4-b]piperazine	page 110
Chapter 7: The preparation of cyclic nitramines	page 113
7-01. RDX. Cyclonite; Hexahydro-1,3,5-trinitro-1,3,5-triazine; 1,3,5-trinitrohexahydro-s-triazine; cyclotrimethylenetrinitramine	page 113
Composition B	page 118
RDX explosive composition	page 119
PBX explosive composition	page 119
RDX high performance rocket propellant	page 119
C3 plastic explosive	page 120
C4 plastic explosive	page 120
RDX explosive munitions	page 121
7-02. Solex. 1-(N)-acetyl-3,5,7-trinitro-cyclotetramethylene Tetramine	page 123
Solex explosive composition	page 124
7-03. HMX. Octogen; 1,3,5,7-tetranitro-1,3,5,7- tetraazacyclooctane; alpha-HMX and beta-HMX	page 124
HMX gun propellant	page 128
HMX explosive	page 128
HMX plastic explosive	page 128
PBX B HMX explosive composition	page 129
HMX explosive	page 129
7-04. NINHT. 2-nitroimino-5-nitro-hexahydro-1,3,5-triazine	page 129
7-05. TNAD. 1,4,5,8-Tetranitro-1,4,5,8-tetraazadecalin	page 131
7-06. DPT. 1,5-methylene-3,7-dinitro-1,3,5,7- tetraazacyclooctane	page 134
Chapter 8: The preparation of nitramines	page 136
8-01. DITN. Diisopropylamine trinitrate	page 136
8-02. DMMD. 2,4-dinitro-2,4-diazapentane	page 137
8-03. Tetryl. Nitramine; N-methyl-N,2,4,6- tetranitrobenzenamine	page 139
Tetry explosive booster composition	page 141
8-04. MNA. Methylnitramine	page 141
8-05. Methylene dinitramine	page 144
8-06. HNIW. 2,4,6,8,10,12-hexanitro-2,4,6,8,10,12-	

CONTENTS

Hexaazaisowurtzitane	page 146
Chapter 9: The preparation of nitramines	page 151
9-01. ADN. Ammonium dinitramide	page 151
9-02. KDN. Potassium dinitramide	page 154
Chapter 10: The preparation of amino nitro benzenes	page 158
10-01. Tetraniline. Tetranitro aniline	page 158
Tetraniline explosive	page 160
10-02. TATB. 1,3,5-triamino-2,4,6-trinitrobenzene	page 160
RDX/TATB booster composition	page 164
TAT TATB/TNT explosive composition	page 164
10-03. DATB. 1,3-diamino-2,4,6-trinitrobenzene	page 165
10-04. DATBA. 5-Carboxy-1,3-diamino-2,4,6-trinitrobenzene	page 167
10-05. A-NPNT. 4-amino-N,2,3,5,6-pentanitrotoluene	page 169
10-06. UDTNB. 5-ureido-1,3-diamino-2,4,6-trinitrobenzene	page 171
10-07. DNPU. 2,4-dinitrophenylurea	page 174
10-08. ADNBF. 7-amino-4,6-dinitrobenzofuroxan	page 176
10-09. TNPU. N,N'-bis(2,4,6-trinitrophenyl)urea	page 177
Chapter 11: The preparation of nitro benzenes	page 180
11-01. TNT. 2,4,6-trinitrotoluene; trinitrotoluene	page 180
Composition A1	page 185
TNT blasting composition	page 186
TNT wax composition	page 186
Hexotonal RDX/TNT explosive composition	page 187
Octol explosive composition	page 187
TNT explosive munitions	page 187
11-02. F-TNB. 1,3,5-trifluoro-2,4,6-trinitrobenzene	page 188
11-03. TCTNB. Trichlorotrinitrobenzene; 1,3,5-trichloro-2,4,6-Trinitrobenzene	page 190
11-04. Picryl Chloride. 1-chloro-2,4,6-trinitrobenzene	page 191
11-05. TNBCl. Trinitrobenzylchloride	page 192
Chapter 12: The preparation of poly nitro benzenes	page 194
12-01. HNB. Hexanitrobibenzyl; 2,2', 4,4', 6,6'-hexanitrobibenzyl	page 194
12-02. HNS. Hexanitrostilbene	page 195
12-03. TNTPB. 1,3,5-trinitro-2,4,6-tripicrylbenzene	page 198
12-04. PNT. 2,3,4,5,6-pentanitrotoluene	page 200
12-05. HNBP. Hexanitrobiphenyl	page 202
12-06. Hexaditon. 2,2',4,4',6,6'-hexanitrodiphenylmethane	page 203
12-07. TNN. Nitronaphthalene; 1,3,6,8-tetranitronaphthalene	page 205
Chapter 13: The preparation of nitrate esters	page 209
13-01. EDT. N,N'-di-(2-ethanol)ethylenediamine tetranitrate	page 209
13-02. Nitrocellulose. Nitrated cellulose; Gun cotton	page 212
Gun propellant	page 219
Gun propellant	page 219
Smokeless powder	page 219
Blasting powder	page 220
Blasting powder	page 220
13-03. ETN. Erythritol tetranitrate	page 220
13-04. PEN. Pentaerythritol trinitrate	page 221
13-05. PETN. Pentaerythritol tetranitrate; 2,2-Bis[(nitrooxy)-methyl]-1,3-propanediol dinitrate	page 225
Blasting explosive	page 229
PETN bonded explosive	page 229
PETN propellant charge	page 229
Pentolite PETN composition	page 229
Semtex PETN explosive	page 229
PETN explosive munitions	page 230
13-06. NQ. Nitroglycerine	page 230

CONTENTS

HESP high-energy smokeless powder	page 232
Dynamite	page 233
13-07. Nitro starch. Nitrated cornstarch	page 233
Nitro starch explosive composition	page 234
13-08. EGDN. Ethylene glycol dinitrate	page 234
13-09. Metriol.	page 235
13-10. Nitropropylene. PGDN. Propylene glycol dinitrate	page 237
Chapter 14: The preparation of polyhydric nitrate esters	page 240
14-01. Hexanitate. Sorbitol hexanitate	page 240
14-02. Quebrachitol nitrate. Monomethyl cyclohexanepentanitate	page 241
14-03. Inositol nitrate. Inositol hexanitate	page 243
14-04. MGP. N-Methyl gluconamide pentanitate	page 245
14-05. MON. Maltose octanitate	page 246
14-06. MX. Nitromannite;	page 248
14-07. PVN. Polyvinylnitrate	page 250
Chapter 15: The preparation of nitrate ester nitramines	page 253
15-01. NMHAN. N-Nitro-N-methylhydroxy acetamidenitrate	page 253
15-02. DINA. Dinitroxydiethylnitramine	page 254
15-03. DNAN. Dinitroxydiethylamine nitrate	page 259
15-04. NENA. N-(2-Nitroxyethyl)nitramine	page 261
15-05. Silver NENA. N-(2-Nitroxyethyl) nitramine, silver salt	page 263
Chapter 16: The preparation of nitro triazoles	page 265
16-01. NTA. 3,5-Dinitro-1,2,4-triazole	page 265
16-02. MNTA. 1-Methyl-3,5-dinitro-1,2,4-triazole	page 267
16-03. CDNTA. 3,5-Dinitro-1,2,4-triazole-copper salt	page 269
16-04. NTO. 3-nitro-1,2,4-triazol-5-one	page 271
16-05. 5-NDTT. 5-nitro-2(3,5-diamino-2,4,6-trinitrophenyl)- 1,2,4-triazole	page 272
Chapter 17: The preparation of nitro tetrazoles	page 276
17-01. SATP. di-Silver aminotetrazole perchlorate	page 276
17-02. CNTA. Copper salt of 5-nitrotetrazole CNTA priming mixture	page 277
17-03. HGNTA. Mercury nitrotetrazole HGNTA priming mixture	page 280
17-04. LNTA. Lead nitrotetrazole, basic salt	page 282
17-05. TADA. 5,5'-bi-1H-tetrazole diammonium salt	page 284
Chapter 18: The preparation of nitro phenyls	page 287
18-01. TPG. 2,4,6-trinitrophenylglucitol	page 287
18-02. DNP. 2,4-Dinitrophenol Phenolene explosive composition	page 288
18-03. DNR. 4,6-dinitroresorcinol	page 290
18-04. Picric Acid. 2,4,6-trinitrophenol Pentotal explosive composition	page 291
18-05. Styphnic Acid. 2,4,6-trinitro-1,3-benzenediol	page 294
18-06. Picramic acid. 2-amino-4,6-dinitrophenol	page 296
18-07. Methylpicric acid. 2,4,6-trinitro-3-methylphenol Explosive composition	page 298
18-08. TA. Trinitroanisole	page 299
Chapter 19: The preparation of nitro phenyl salts	page 302
19-01. Lead-TNP. Trinitrophenylglucitol lead salt Lead-TNP ignition/initiating mixture	page 302
19-02. Barium Styphnate	page 303
19-03. Lead Styphnate. 2,4,6-trinitro-lead-II-resorcinate	page 304
19-04. Ammonium Picramate. Ammonium 2-amino-4,6- dinitrophenolate; Ammonium-2-amino-4,6-dinitropicrate	page 305
19-05. AP. Ammonium Picrate	page 308
19-06. Lead Picrate. 2,4,6-Trinitro-lead-phenolate basic	page 310
	page 311

CONTENTS

Lead picrate initiating mixture	page 312
19-07. Sodium picramate. Ammonium 2-amino-4,6-dinitrophenolate; Ammonium-2-amino-4,6-dinitropicrate	page 313
Chapter 20: The preparation of nitrates, chlorates, and perchlorates	page 315
20-01. AN. Ammonium Nitrate	page 315
AN/Aluminum blasting prill	page 317
Blasting composition	page 317
ANFO	page 317
ANFO B	page 317
AN black powder	page 318
AN explosive munitions	page 318
20-02. AC. Ammonium chlorate	page 319
20-03. APC. Ammonium perchlorate	page 320
Perchlorate high performance rocket propellant	page 321
Perchlorate high performance rocket propellant	page 321
Perchlorate high performance rocket propellant	page 322
20-04. PCB. Perchlorylbenzene	page 322
20-05. Nitro-PCB. 3-Nitroperchlorylbenzene	page 323
20-06. BDC. Biguanide diperchlorate	page 325
20-07. EDDN. Ethylenediamine dinitrate	page 326
Chapter 21: The preparation of paraffins and their derivatives	page 328
21-01. Nitroform. Trinitromethane	page 328
21-02. HNF. Hydrazine nitroform; Hydrazinium nitroformate	page 332
21-03. KNF. Potassium nitroform	page 334
21-04. Silver nitroform	page 335
21-05. TNM. Tetranitromethane	page 336
21-06. TBA. 4,4,4-Trinitrobutyraldehyde	page 340
21-07. TNB. 4,4,4-Trinitro-1-butanol	page 341
21-08. 4,4-DNB. 4,4-Dintro-1-butanol	page 343
21-09. HNH-3. 1,1,1,6,6,6-Hexanitrohexyne-3	page 344
21-10. TNP. 1,1,1,2-Tetranitropropane	page 346
21-11. TNEN. 2,2,2-Trinitroethyl-2-nitroxyethyl ether	page 347
21-12. NTND. 2-Methyl-2-(N-nitro-N-trinitroethylamino)-1,3-propyl dinitrate	page 352
Chapter 22: Miscellaneous	page 355
22-01. TNA. 1,3,5,7-Tetranitroadamantane	page 355
22-02. TND. 1,4,6,9-Tetranitrodimantane	page 358
22-03. Nitroguanidine	page 361
22-04. NU. Nitrourea	page 362
22-05. Acetone-P; Acetone peroxide	page 363
22-06. Tetracene. Tetrazene	page 265
References	page 367

Introduction: a quick lesson in chemistry

Chapter 1: Introduction to chemistry

The Preparatory Manual of Explosives has been written to teach the art of explosives sciences to the reader. To do this, you should take a quick, yet vital lesson in chemistry. First of all, the world of chemistry is a fascinating world filled with a huge variety of chemicals, chemical reactions, formulas, laboratory apparatus, and an arsenal of equipment. All these elements are combined and used thoroughly to bring about chemical change of matter from one form to the next. In this book, the form of change that we will deal with mostly, is the formation of compounds that possess great energy. These compounds that possess great energy, are called high explosives.

The world of high explosives is nothing new, but it's quite unfamiliar to most people. If you were to ask the common man about C4 plastic explosive for example, they would probably say it was something they saw on TV, and it went "bang" with a great fireball. Well, this is not what C4 does or is, and the first rule you should actually learn (before we hit the chemistry), is forget about all the stuff you see on TV and in the movies—TV and Hollywood movies are full of it.

Now that we have discussed the first crucial step to fully filling the necessary requirement for the understanding of explosives sciences, we should enter the world of chemistry. As previously stated, the world of explosives is relatively unknown to most people, as a result, many of the procedures in this book may seem foreign, or unfamiliar to you—if this is the case, then at this exact moment, you are in the right place. By the time you have read this book, these "foreign" procedures will no longer be foreign to you, but in the meantime, let's get started on the world of chemistry.

The world of chemistry involves every single aspect, corner, and micro drop of everything that is matter. Our solar system and the entire universe all function on a chemical level—In essence, chemistry is everything. The universe and everything in it is composed of atoms and molecules, and within this massive space, there exists tens of millions of chemical compounds—either known or unknown. The compounds that are known make up only 5% of the naturally occurring compounds, leaving a massive 95% of them being synthetic (prepared in the lab)—all explosives are synthetic.

Chemistry has been divided into three fields over the last 100 years to better organize and format the system. The three major branches of chemistry include: Inorganic chemistry, Organic chemistry, and Biochemistry. In short, inorganic chemistry deals with ionic compounds, which make up the chemical compounds that do not contain active carbon. Organic chemistry is the largest branch of chemistry and it deals with covalent compounds, which make-up our everyday items like plastics, drugs, dyes, pesticides, insecticides, resins, fibers, and explosives. Organic means "carbon bearing" which means any compound that bears carbon is classified as organic. Gasoline, turpentine, and candle wax are specific examples of organic compounds. Last but not least, biochemistry studies the field of enzymes, organisms, plants, and animals and their active chemical processes. Genetics research studies the DNA and RNA of living things and is a sublevel of biochemistry. DNA and RNA is composed of organic compounds all linked and actively working together. Biochemistry deals heavily with peptides, amino acids, carbohydrates, etc., etc., all of which play a major role in natural process such as cells, metabolism, and the like. Biochemical processes show a remarkably potential for explosives production in the future, but this technology is radical, and not yet fully developed—meaning that in the future, some high explosives could be produced by living things, and then harvested. Kind of like how morphine is extracted from opium, which is "harvested" on a commercial scale. Note: biochemical processes will not be discussed in this book.

1. Chemical bonding: Oxidation states

First things first, you need to understand the nature of elements, and their oxidation states (number of bonds). Every single element is capable of forming chemical bonds with other elements (with the exception of a few "noble gases"). The oxidation states are what determines how many bonds a particular element can form, and to what other elements. When elements combine, they form chemical compounds. All of the atoms within a chemical compound show specific oxidation states. Oxidation states are not really states, but definitions of bonding, which are dictated by each individual element. Each element can form any where from either 0 to 7 bonds. These numbers represent the number of bonds the element can form (look at a modern periodic table, such that included in the "Merck Index"—the oxidation states are written in the upper left corner of each element). These numbers clearly indicate the number of bonds each element is capable of forming.

Chapter 1: Introduction to chemistry

As most people are aware, periodic tables include rows and columns filled with elements. The elements within any given column have similar properties and characteristics along with similar oxidation states. For example, the elements of column 5A on the periodic table include nitrogen, phosphorus, arsenic, antimony, and bismuth. All these elements have similar oxidation states and properties. Phosphorus for example, can form compounds with three bonds or five bonds (indicated by the numbers +3, -3, and +5). Phosphorus, like arsenic and antimony have oxidation states of +3, -3, and +5. Phosphorus can form either +3 or +5 oxidation states when it bonds to elements with higher electro negativities (also listed on some periodic tables), and -3 oxidation states with elements that have lower electro negativities. Each element has different electronegative energies. Metals for example, have electro negativities ranging from 0.60 to 1.9. Non-metals have electro negativities ranging from 1.9 to 4.0. In essence, elements that are metals combine with the elements called non-metals forming positive oxidation states, with the so-called non-metals forming negative oxidation states.

In a specific example, when phosphorus reacts with non-metals it forms +3 and +5 oxidation states because its electronegative energy is less than the other non-metals, but when it bonds to metals, its oxidation state is -3 because its own electro negative energy is greater than most metals.

Either way, when two elements combine for example, the element with the greater electronegative energy forms negative oxidation states, and the element with the lower electronegative energy forms positive oxidation states. In another example, chlorine and bromine both have greater electronegative energies, so when they combine with phosphorus, the phosphorus forms +3 and +5 oxidation states (see the illustration below). When elements combine they form compounds, which are called molecules.

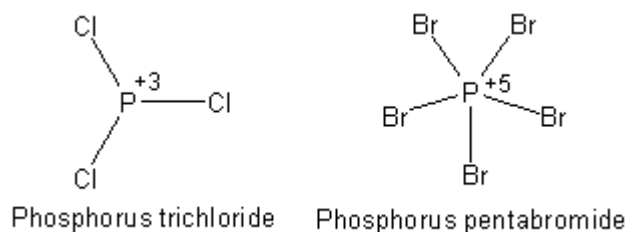

Elements such as lithium, sodium, and potassium form only one bond, because they have only a +1 oxidation state, and because their electronegative energies are quite low (ranging from 1.0 to 0.6). A more complex array of oxidation states is demonstrated in the element nitrogen (a key element found in most high explosives). It's capable of forming +1, +2, +3, +4, +5, -1, -2, and -3 oxidation states (see the illustration below). Another crucial element, carbon, is capable of forming +2, +4, and -4 oxidation states, and the all important oxygen, forms only a -2 oxidation state. Hydrogen can form +1 and -1 oxidation states. Remember the elements helium, neon, and argon (called the noble gases) form no oxidation states. Note: The oxidation states of each element (and column of elements on the periodic table) have been determined by trial and error over some 200 years of chemical research and study.

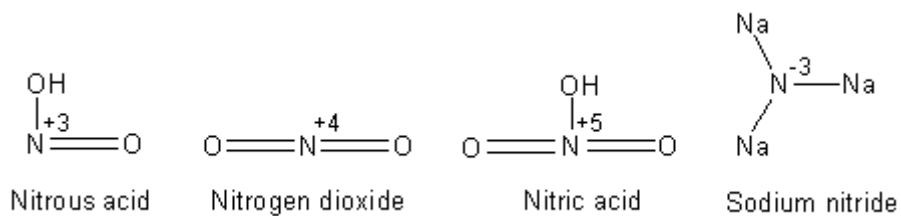

2. Ionic compounds and ionic bonds

Ionic compounds are composed of elements bonded together that have marked differences in electro negativities. Ionic compounds make up the bulk of "inorganic compounds", and are composed primarily of metals bonded to non-metals. In ionic compounds, the oxidation states of each element follows the same rules governed by the number of bonds each element can form. In the case of ionic compounds, the positive and negative numbers represented by the number of bonds each element can form, is more detailed and also represents a charge attributed to each element. For example, when phosphorus bonds to chlorine, it forms +3 or +5 oxidation states, and the chlorine forms a single -1 oxidation state; however in this example, because the electronegative difference between the phosphorus and the chlorine is not very significant, the resulting phosphorus trichloride or pentachloride is not considered fully to be ionic. However, in the case of sodium chloride, a +1 sodium ion is bonded to a -1 chlorine atom, with each positive and negative mark defined as a charge. Compounds that have their oxidation states defined as actual charges are considered to be ionic. As a reminder, remember that oxidation states (the numbers) define the number of bonds an element can form, never mind the positive or negative marks each number has. In ionic compounds the molecules are made up of positive and negatively charged atoms corresponding to their oxidation state number (the number of bonds each element can form, i.e., the oxidation state number defines the number of bonds each element can form, but not their electrical charge in all molecules—just in ionic molecules.

The electrical charge of each element within an ionic molecule is different than the element's electronegative energy. Note: Electronegative energy determines whether the element forms positive or negative oxidation states. Electrical charge is determined after the atoms combine, and is represented by the positive or negative oxidation state independently from the actual number of bonds each element can form.

As previously stated, chlorine is more electronegative than sodium, so when they combine the chlorine forms a -1 oxidation state (notice on a periodic table that chlorine has an oxidation state of $+1$, -1 , $+5$, and $+7$; and sodium has an oxidation state of $+1$). Some periodic tables give the electronegative energy of each element, and using such a periodic table, you will notice that the electronegativity of chlorine is remarkably higher than that of sodium. Because the difference between electronegative energies is so great, the chlorine becomes negatively charged, and the sodium becomes positively charged. These charged atoms attract each other, and hence form a bond based on their electrical attractions (like two magnets)—this is the basis of “ionic” bonds.

Oxidation states also determine the number of electrons that can be captured. As previously discussed, ionic compounds like sodium chloride form their bonds based on electrical attractions. These attractions are determined by the number of electrons a particular atom captures. When chlorine combines (reacts) with sodium it forms a -1 oxidation state. Again, because the difference in electronegative energies is so great, the chlorine grabs or captures one of the sodium's electrons. This capturing causes the chlorine to become negatively charged. As a result, the sodium atom becomes positively charged. Atoms become negatively charged when they capture electrons, and become positively charged when they lose electrons. This capturing and losing of electrons is the scientific foundation to ionic bonding and ionic compounds.

Currently there are about 200,000 ionic compounds known to man (most of them being synthetic). The most common ionic compound is table salt or sodium chloride. Some common examples of ionic compounds include potassium permanganate, sodium azide, sodium nitrate, potassium chloride, sodium fluoride, potassium chlorate, and zinc sulfate. Ionic compounds make up the majority of the earth, solar system, and the universe.

3. Covalent compounds and covalent bonds

Covalent compounds make up the bulk of chemical compounds known to man, but they only make up a small percentage of the chemical compounds found on earth and earth-like planets, and virtually most solar systems. As previously stated, there are about 200,000 ionic compounds known to man, with a potential of another 100,000 left undiscovered throughout the universe; however, covalent compounds number in the millions. For example, currently there are 16,000,000 covalent compounds known to man (as of 2003). The possible number of covalent compounds is practically endless, as the combination of these compounds is virtually infinite.

Covalent compounds contain covalently bonded carbon atoms. The term “organic” means ‘carbon bearing covalent substance’. Covalent compounds all contain specific carbon atoms, which make up the foundation or infrastructure of all organic compounds. A covalent compound such as hexane for example, is composed of covalently bonded carbon atoms all bonded together to form a chain—this chain represents the backbone or infrastructure of the molecule. The carbon atoms that make up these backbones or infrastructures, are themselves bonded directly to other atoms such as hydrogen, oxygen, nitrogen, sulfur, phosphorus, arsenic, etc., etc. Such examples of covalent compounds (organic compounds) include: ethyl alcohol, isopropyl nitrate, aspirin, acetaminophen, cocaine, and octane.

Covalent bonds are much different than ionic bonds, as they share electrons rather than “capture” them. Remember that ionic bonds are formed when two or more elements with distinctive differences in electronegativities react with one another—whereby the greater electronegative element captures an electron (or more) from the less electronegative element(s). Covalent bonds, however, are formed when two or more elements combine and the electrons are shared (paired) rather than captured. In order for a covalent bond to form, the electronegative differences between the elements cannot be very significant, meaning their differences are much less than those encountered with ionic bonds.

Covalent bonds cover a whole echelon of reactions, many of which can be very complex and/or require special conditions depending on the chemicals and reaction conditions, and usually require multiple reactions and steps to achieve desired products. In other words, ionic compounds tend to be rather simplified compounds with easy formulas, whereas organic compounds can be huge molecules, which require many steps for their preparation. These multiple steps are the basis for organic chemistry, as it deals with a whole multitude of reactions and functional groups—most of these reactions and functional groups will not be discussed in this book (as it would take about 100,000+ pages), but what functional group reactions that will be discussed are the nitro functional groups commonly found in high explosives.

In general, covalent bonds are less stable than ionic bonds. Most ionic compounds are stable solids with relatively high melting points (ranging from 200 to 2400 Celsius). Many ionic compounds can be heated to very high temperatures without any significant decomposition, such examples include: aluminum oxide, iron oxide, sodium chloride, and magnesium chloride. Most organic compounds decompose when heated to temperatures above 300 to 500 Celsius. The high melting points of ionic compounds are due primarily to crystal structure, and the result of strong electrical attractions between the elements and the molecules—these attractions can lead to super strong crystal lattices, as seen in some compounds like aluminum oxide (emeralds), and other ionic oxides (gems and sapphires). There is one mere example of an organic compound that should be demonstrated here; diamonds are composed of covalently bonded carbon atoms, with the molecules forming super strong crystal lattices.

Other than this isolated example, most covalent compounds are solids or liquids with relatively low melting points and boiling points. This is the result of weaker electrical attractions between the molecules. In covalent compounds the weaker attractions exist primarily because the covalent molecules lack ionic charges, and are thereby not attracted or repelled to each other very much. Because of the lack of electrical attractions between covalent molecules, the boiling points of covalent molecules are the result of “intermolecular” forces (the melting points will be discussed shortly). Intermolecular forces are forces that exist between elements within one molecule upon different elements within another molecule. Such an example would be water, common hydrogen oxide. Water which is composed of two hydrogens bonded to a single oxygen has a significant boiling point of 100 Celsius at sea level, although it is a relatively small and light molecule. The reason water has such a high boiling point for its small size and weight, is due to intermolecular force attractions between the central oxygen atom of one molecule upon the two hydrogens of another water molecule (adjacent water molecule). The non-bonding type attractions (intermolecular forces) that water molecules have to each other is what defines water’s boiling point. In another example, methylene chloride (a common solvent you will find in this manual) has a very low boiling point for its size and weight (compared to water). The reason methylene chloride has a boiling point of about 60 degrees less than water is due to even weaker attractions between the methylene chloride molecules to each other. In essence, the weak intermolecular forces between the two chlorine atoms of one molecule upon the two hydrogen atoms of another, is what determines the low boiling point of methylene chloride.

As previously stated, the melting points of ionic compounds are high because of strong electrical attractions between the elements and molecules, but a whole different scenario determines the melting points of covalent compounds. Because solid covalent compounds don’t really show any significant intermolecular forces, the melting points of covalent compounds are determined by the shape, size, and bonding angles of the elements within the molecules. For example, think about blocks of wood of the same size, versus wood circular shapes of the same size—which would be easier to stack? Obviously the wood blocks would be much easier to stack than a pile of circular wood blocks. This is basically the essence behind the melting points of covalent compounds—although it gets a little bit more technical than this, but this info will be omitted because it is only of a concern to scientists. Molecules that are shaped properly, will pack together (not literally) much better than molecules that have awkward shapes. Molecules that pack together better, and more evenly, have much higher melting points than molecules that don’t pack or fit together very well. Another factor that plays a role in melting point is size and weight of the molecules. Naturally, larger weight molecules tend to have higher melting points and boiling points than smaller weight molecules.

4. Understanding chemical structures and formulas

Understanding molecular structures and formulas is not necessarily needed for this manual (as all procedures are given with exact quantities) nevertheless, understanding formulas and the like can seriously help you better acknowledge what is taking place during a chemical reaction. Molecular formulas and structures are written using a variety of simple techniques. The most common of these techniques utilizes short lines, which indicate the bonds—of course the letters in the illustrations clearly indicate the elements. In short, the lines represent the chemical bonds either ionic or covalent, and the letters represent the elements (see a periodic table for each letter). In this manual, some of the letters have been omitted to reduce drawing time of the structures, and this method of omission is quite common in chemistry literature. In a common example, ethanol and hexane are both written with their central carbon atoms (and hydrogen atoms) concealed. Note: only carbon and hydrogen are commonly concealed in any given illustration. To know when a carbon has been concealed, simply look at how the lines change angles. Because carbon forms four bonds, it naturally contains two hydrogens per carbon (with the exception of alkenes, alkynes, benzenes and phenyls) within the central structure—these hydrogens are also concealed.

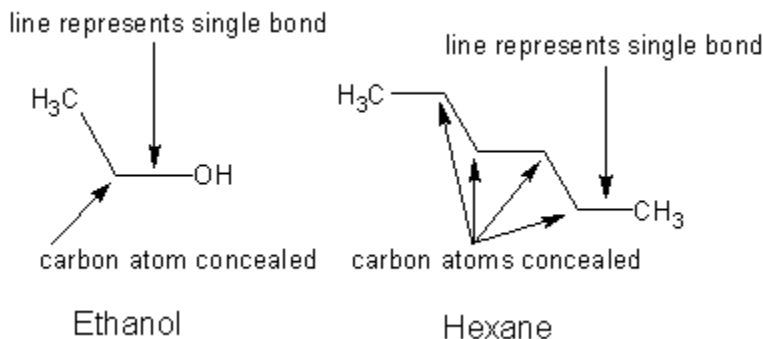

For review, the single lines represent single bonds, and the letters represent atoms. Therefore the letter C represents carbon, the letter O represents oxygen, and the letter H represents hydrogen. In the above illustration the central carbon atom in ethanol is concealed, along with two hydrogens bonded to it—this is the same scenario for hexane with a total of four carbon atoms concealed, along with eight hydrogens. Another method of writing structures and formulas is to use “expanded notation”. For example, the structure of ethanol could be written as follows:

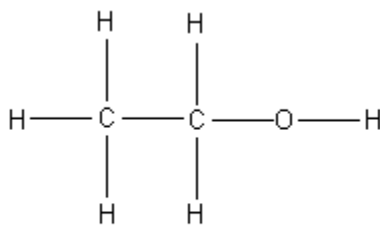

Ethanol

The above illustration is a common example of a molecular structure written in expanded notation. Expanded notation shows all elements within the structure. Expanded notation is seldom used in chemical literature to save writing time. In the following illustration we see a similar written structure with the central carbon atom concealed, along with the corresponding hydrogen. In this example, two lines are written to represent a double bond, in this case between the central carbon and an adjacent oxygen atom. In the right structure, a straight-line triple bond is shown, with the central carbon atom concealed as usual—as suspected, the letter N represents nitrogen.

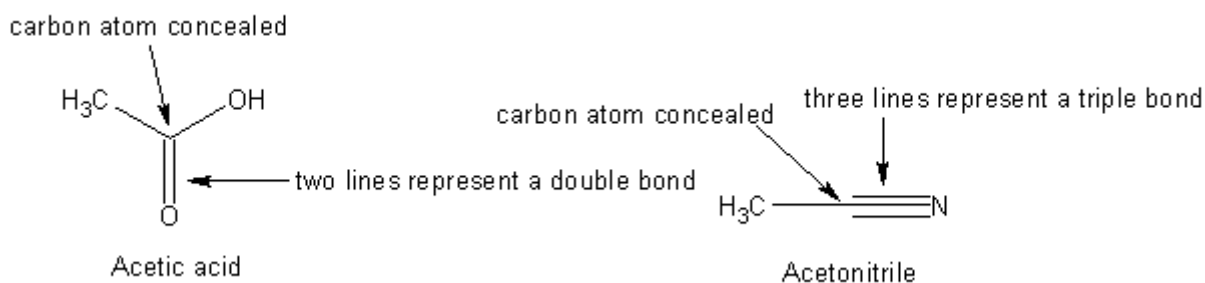

Many covalent compounds are composed of rings. Rings are structures with a high degree of stability and belong to either a saturated group, or an unsaturated group. In the following illustration, the structure on the left is called cyclohexane, which represents a saturated ring. The right structure is the classic compound called benzene. In both structures, all carbon atoms have been concealed, along with the adjacent hydrogens—this is how most rings will be illustrated. The benzene structure represents an unsaturated ring. When discussing saturation and unsaturation, rings are not the only covalent compounds capable of these definitions. Many straight chain, and branched structures are capable of forming saturated and unsaturated structures—these are classified as alkynes, alkenes, and alkanes. An example of an unsaturated compound is the chemical acetylene, and an example of a saturated compound is the chemical propane. Another example are oils such as olive oil, which contain long chain unsaturated compounds—mainly oleic acid in this case.

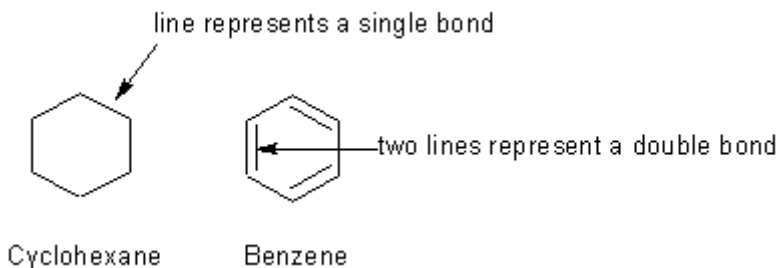

The final, and most common method of writing structures and formulas involves “condensed formula notation”. Condensed formula notation simply excludes the lines. To save time and space, many chemists use condensed formula notation. In this book, many of the reagents and solvents will be written in condensed formula notation. The following illustration gives a few examples of condensed formula notation.

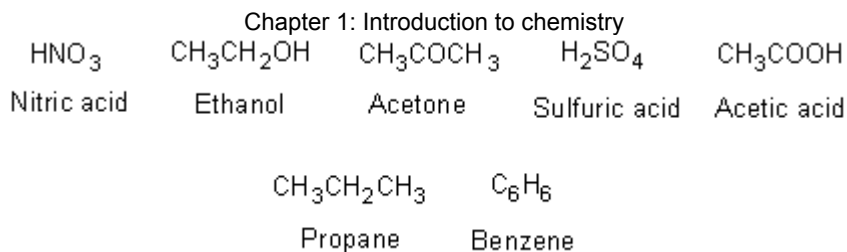

5. Chemical reactions

“Chemical reaction equations” are commonly used to illustrate a chemical reaction. In a chemical reaction equation the arrow represents the path the reaction takes. The items listed above and below the arrow represent the reagents, temperature, and/or conditions that exist for and during the reaction. In the following illustration we start with the “intermediate” compound called aniline. The intermediate compound is usually written on the left hand side, but can be written on the right hand side as long as the arrow is pointing to the left. The intermediate is other wise called “the starting compound”. In the illustrated chemical reaction equation below, the arrow pointing to the right tells us that aniline is treated with a mixture of nitric acid and sulfuric acid at 80 Celsius. The nitric and sulfuric acids are commonly called the “reagents”, and are usually written in condensed formula notation. The reagents are usually written above and/or below the arrow (basic chemistry classes often put the reagents after a + sign, but in the professional world, we don’t use + signs). Under most conditions, to shorten the illustration, we omit the by-products formed during the reaction (but sometimes it helps the reader understand better what is going on when the by-product are given; however, by-products will not be given in the illustrations of this book). Although understanding chemical reactions is not fully necessary to properly use this book, a brief understanding will better help you understand what is taking place.

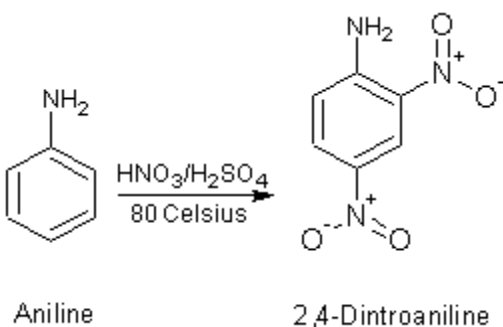

6. Language of chemistry

Chemistry has a unique language all to its own. This language is called the IUPAC language, or system. The IUPAC system of language can be quite difficult and confusing to learn, so we will not go into to much depth in this category. What we will discuss is the basic language of chemistry. For starters, you should familiarize yourself with the numbers 1 through 10. These numbers are given in the following table. After you have learned these numbers, practice them using the illustrated structures below.

Mono: 1	Tri: 3	Penta: 5	Hepta: 7	Nona: 9
Di: 2	Tetra: 4	Hexa: 6	Octa: 8	Deca: 10

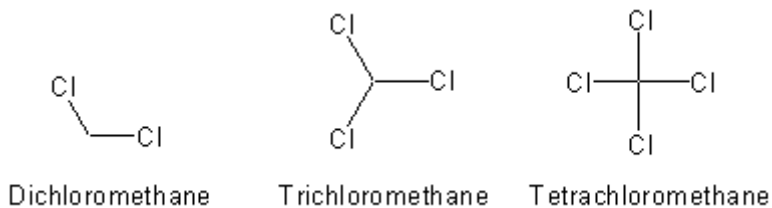

As previously discussed, covalent compounds contain carbon chains, or infrastructures. These carbon chains are numbered so chemists are able to name them. Because the rules that govern the system of numbering can be tricky for beginners to learn, we will not go into to much depth. In the following illustration, butane is shown with correct numbering. Thereafter, another more complicated structure is shown with correct numbering, followed by an even more complicated structure. In each of these examples, the numbering demonstrates how compounds can be numbered and labeled for proper identification.

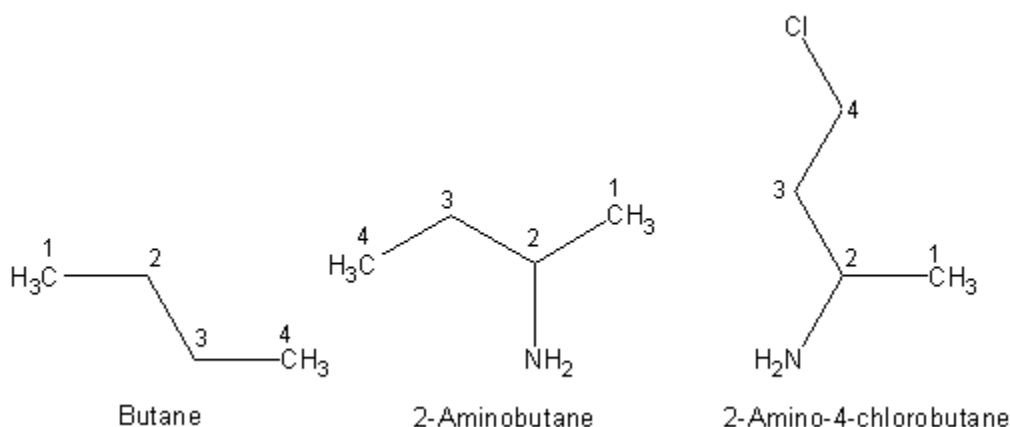

Another important tool for being able to name chemical compounds, is knowing the correct functional group. Functional groups are bits and pieces of molecules that have distinctive properties to them. Functional groups play a major role in determining the correct identification for any given compound. Functional groups can be tricky for many beginners to memorize, so we will not go into too much depth here as well. However, we will discuss a few common functional groups that you will encounter in this book. Take a look now at the following table. Notice each unique functional group, and the corresponding chemical compound it is attached to—notice any patterns? The primary functional groups that we will deal with in this book are nitro groups.

Some common functional groups					
-NO ₂ (nitro)		Nitromethane	-NH ₂ (amine)		Ethyl amine
-COOH (carboxylic acid)		Acetic acid	-CN (Nitrile)		Acetonitrile
-OH (alcohol)		Ethanol	-CH ₃ (Methyl)		Methane

As far as the IUPAC system and functional group are concerned, most chemical compounds are identified and named in these manners; although, in some cases, common names have been attributed to many chemical compounds to simply make it easier to identify them. For example, the names of the three chemical formulas illustrated at the top of the page are written in IUPAC nomenclature, but experienced chemists will simply name these compounds methylene chloride (dichloromethane), chloroform (trichloromethane), and carbon tetrachloride (tetrachloromethane). Even though common names are quite common for identifying chemicals, the correct IUPAC name should be given in special cases to correctly identify the compound. For example, 2-amino-4-chlorobutane would not make sense if we simply called it aminochlorobutane. Saying aminochlorobutane does not depict where on the carbon chain the amino functional group is, or the chlorine atom.

7. Conversion factors

For some readers (especially Americans), the metric system (other wise known as the SI system) is vague, or somewhat unfamiliar. 99% of all the units of weight and measurement in this book are given using the SI system; therefore, a translation from one unit to another may be needed for some to fully interpret the quantities. As most people are probably aware however, most laboratory equipment is automatically calibrated in SI units, so even inexperienced persons will not have to worry too much about knowing the SI system. Regardless, try a few conversions of your own just for practice. Example: Convert 150 Celsius into Fahrenheit—Solution: multiply 150 by 1.8 and then add 32. The answer would be 302 Fahrenheit. Example 2: Convert 1.2 gallons into milliliters—Solution: multiply 1.2 by 3,785. The answer would be 4542 milliliters.

To convert	Into	Multiply By	To convert	Into	Multiply By
Atmospheres	Cm of mercury	76	Liters	Gallons	0.2642
Atmospheres	Mm of mercury	760	Liters	Ounces (fluid)	33.814
Atmospheres	Torrs	760	Meters	Feet	3.281
Atmospheres	In of mercury	29.92	Meters	Inches	39.37

Chapter 1: Introduction to chemistry

Atmospheres	psi	14.7	Milligrams	Ounces	3.527×10^{-5}
Celsius	Fahrenheit	$1.8 + 32$	Milligrams	Pounds	2.2046×10^{-6}
Centimeters	Inches	0.3937	Milliliters	Gallons	2.642×10^{-4}
Centimeters	Meters	0.01	Milliliters	Ounces (fluid)	0.0338
Centimeters of mercury	Atmospheres	0.01316	Millimeters	Feet	3.281×10^{-3}
Centimeters of mercury	psi	0.1934	Millimeters	Inches	0.03937
Fahrenheit	Celsius	$0.556 - 17.8$	Ounces	Grams	28.349527
Feet	Meters	0.3048	Ounces	Kilograms	0.0283
Feet	Millimeters	304.8	Ounces	Milligrams	28,349.5
Gallons	Liters	3.785	Pints (liquid)	Liters	0.4732
Gallons	Milliliters	3,785	Pints (liquid)	Milliliters	473.2
Grams	Ounces	0.03527	Pounds	Grams	453.5924
Inches	Centimeters	2.540	Pounds	Kilograms	0.4536
Inches	Millimeters	25.40	psi	Atmospheres	0.06804
Inches of mercury	Atmospheres	0.03342	Quarts (liquid)	Liters	0.9464
Inches of mercury	psi	0.4912	Quarts (liquid)	Milliliters	946.4
Kilograms	Ounces	35.274	Torr	Mm of mercury	1.0
Kilograms	Pounds	2.205	Torr	Atmospheres	1.316×10^{-3}



Tutorial

Chapter 2: Laboratory techniques, and procedures

Chapter 2 is dedicated to teaching basic laboratory techniques. To fully use this book you must take a quick guide into the modern lab, and learn a few examples of laboratory techniques. Laboratory techniques are an essential part of everyday chemistry. The most common laboratory techniques include extraction, recrystallization, and distillation. You will learn how to do these in this chapter. Other laboratory techniques include lab safety, glassware, and equipment.

1. Lab Safety

Lab safety is the first step in proper laboratory techniques. For each chemical procedure, read directions carefully, and know precisely what you need to do, before you actually do it. After reading the procedure think about the procedure, and know the hazards associated with it. Know the chemicals used in the procedure and how to properly handle them. Do not attempt to alter the procedure or change chemicals. The best safety is to prevent accidents before they happen.

Always remember to wear safety goggles at all times. Clothing and equipment can be replaced, but your eyes cant. Contact lenses or glasses are not a substitute for safety goggles. If you get chemicals in your eyes (liquid, gas, or vapor) immediately flush with large amounts of water.

Immediately wash off any chemical you happen to spill on yourself. Most chemicals are dangerous only if they linger, so take action at once. Concentrated sulfuric acid is not very harmful if washed off immediately, and most acids do little or no skin damage if they are immediately washed off with water.

In case of an accident such as a fire, save yourself first. Keep fire extinguishers in arms reach, and have an adequate water source within reach. For acid spills, simple baking soda can be used to neutralize it.

Avoid open flames in a laboratory setting, and do not smoke in the lab. In the event of a fire, calmly but quickly move away from the burning area. Fight the fire only if you are confident the fire can be extinguished.

Do not eat or drink food products while in the lab. Food and drink can become contaminated by accident, and never use laboratory glassware for eating or drinking.

Never taste chemicals, and never smell chemicals by sticking your nose right up to the container. Smell chemicals by wafting the vapors with your hand to your nose. Many accidents have occurred when fingers were contaminated in the laboratory and then later used to rub eyes or for eating snacks. Remember to wear gloves at all times. Latex gloves work for most cases, but in some cases nitrile gloves are recommended. Especially when handling strong acids, or chlorinated solvents. If bare handed, wash hands after touching chemicals and/or their storage bottles.

Breathing or handling small amounts of noxious substances does not pose immediate danger, but you should avoid contact with any potentially noxious chemical under all circumstances. Toxic chemicals should be handled with great care, and proper ventilation (fume hoods with maximum settings) should be used. If fume hoods are not available, the toxic chemicals should be handled in well-ventilated rooms with open windows to allow good airflow. Most organic solvents are very volatile and flammable, so proper ventilation should be exercised as well. Always remember, if you can smell a substance, you are breathing it into your lungs.

Wear inexpensive clothing when working in a lab. Since there is a possibility of clothing being destroyed in a laboratory accident, a lab coat or an apron should be worn at all times. Do not wear sandals or thong shoes when in the laboratory. Confine long hair and/or loose clothing while in the laboratory. Do not wear shorts, open skirts, blouses, or any other clothing that leave large areas of skin unprotected.

On a final note, never play around with chemicals by mixing or heating them. Always remember, before you mix and/or heat chemicals know what you are doing. Playing around with chemicals can lead to poisonous fumes, fires, and/or explosions.

2. Laboratory equipment

Understanding laboratory equipment is the next step in laboratory techniques. Laboratory equipment is composed of a variety of tools including heating devices, stirrers, blenders, vacuum pumps, temperature control apparatus, and a variety of glassware, which are all essential tools for carrying out chemical reactions in the laboratory. Laboratory equipment is expensive, but properly maintaining it will ensure long life. Laboratory equipment is widely available through a number of distributors. Most laboratory glassware cannot be heated above 500 Celsius. Quartz glass, which is really expensive, is used in procedures where higher temperatures are needed (up to 1200 Celsius) along with the inertness of glass. Steel, nickel, porcelain, or iron crucibles are used for general heating of solids at high temperatures. General laboratory glassware is used for heating liquids because most liquids will never encounter temperatures exceeding 300 Celsius.

Never rapidly heat glass to a high temperature. Exposing glassware to high temperatures all at once can cause cracks and breakage. Cooling hot glassware to quickly can also lead to cracks and breaks. Always allow the heated glass to cool to room temperature (by itself) before applying it to cold water baths, ice baths, or dry ice baths. Quartz is an exception. It can be heated to 1000 Celsius and then dipped into water. If you get your hands on any quartz glassware, snatch it up like gold and take good care of it. Quartz glassware can be used instead of ordinary laboratory glassware.

Figures 001, 002, and 003 illustrate some common laboratory glassware and equipment. Most modern glassware contains ground glass joints. Ground glass joints are outer (male) and inner (female) etched surfaces that come together forming an airtight seal when pushed together. The most common joint sizes are 24/40, and 19/22—these joints are defined as 24 millimeters width, by 40 millimeters long, and 19 millimeters width by 22 millimeters long. The joint size is commonly referred in the naming of the adapter. For example, a “claisen” adapter (the 4th adapter in figure 001 from the top row going from left to right) is referred to as a “claisen adapter w/24/40 joints.

In some cases sealant grease (commonly called vacuum grease) is applied to the joints to allow for easier disconnection. When connecting adapters, do not push them together to hard. Pushing the joints together to hard may lead to a suction effect between the two adapters. This suction effect can make disconnection of the adapters by hand impossible. In some rare cases the joints can be suctioned together so severely that breakage of the adapters while trying to disconnect them results. If adapters become suctioned together, do not use force to separate them. Place the adapters into a large container filled with water, and boil for several hours. After several hours, the adapters should pull apart easily.

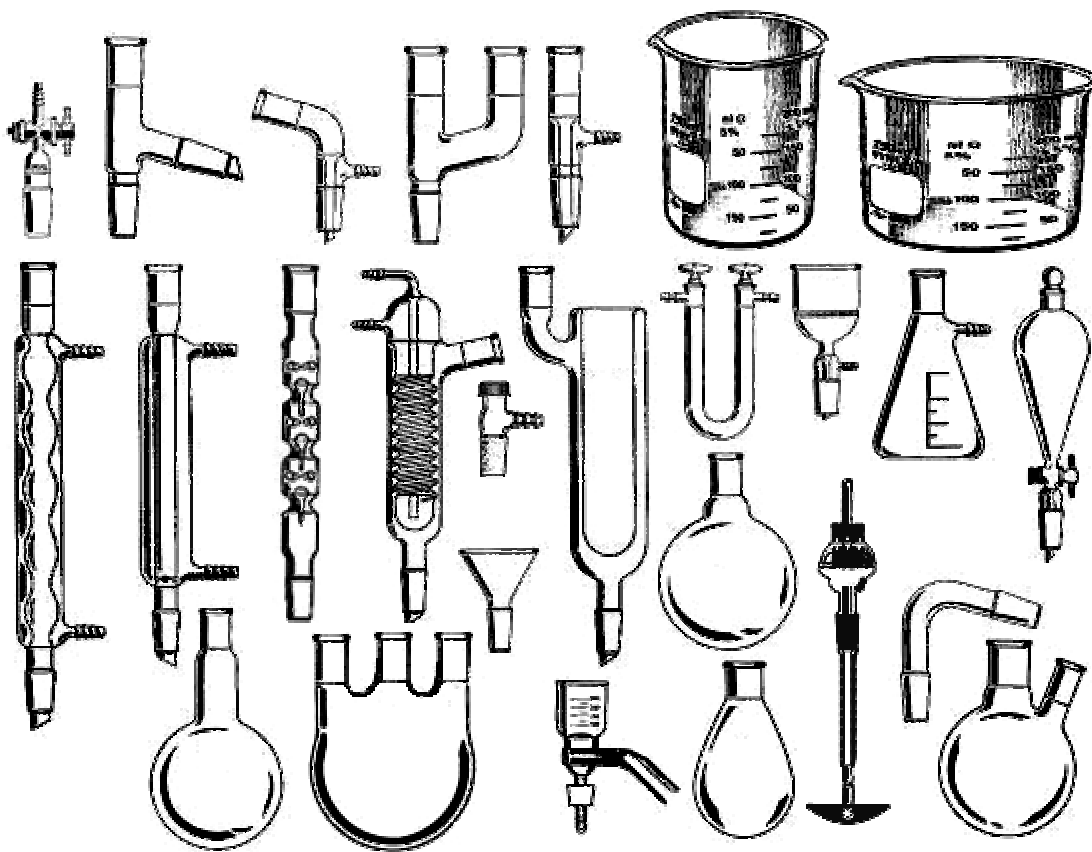

Figure 001. Common laboratory glassware.

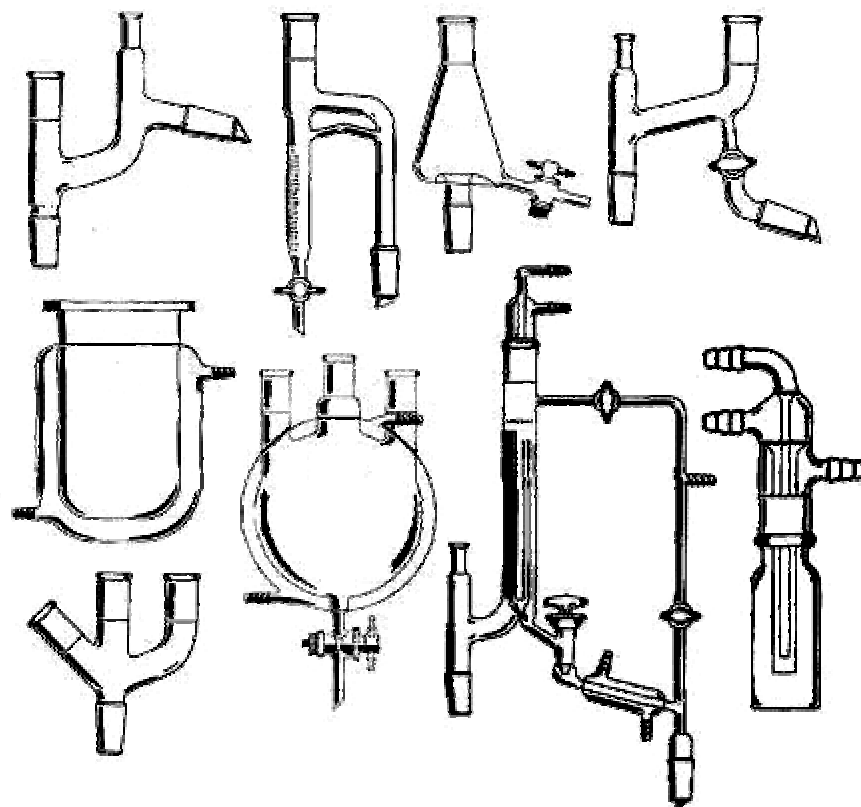

Figure 002. Advanced laboratory glassware.

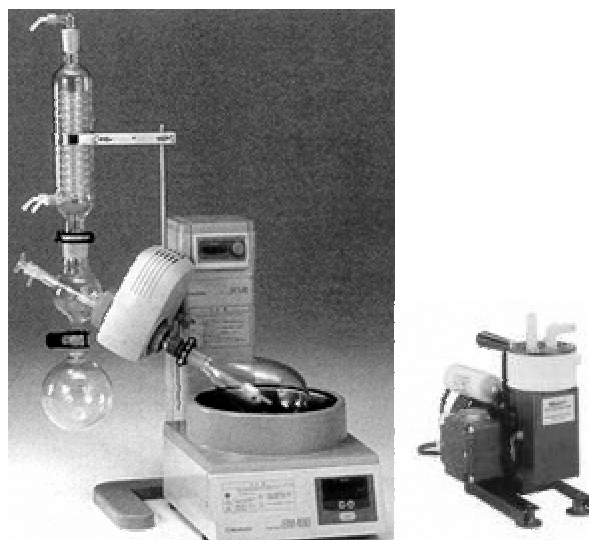

Figure 003. Left: A standard rotary evaporator. Right: A standard vacuum pump.

3. *Methods of heating*

For heating a reaction mixture a variety of factors determine which of many available methods is chosen. These factors include the shape and size of the reaction vessel, the desired reaction temperature, and whether the reaction mixture must be stirred at the same time it is heated. The most common methods of heating used in labs are listed below.

A. Free flame

Bunsen burners refer to the term free flame. The Bunsen burner is a commonly used heating device in general chemistry labs, but its use in modern labs is limited. It is very inexpensive to purchase and operate, and permits mixtures to be heated rapidly. Bunsen burners are also commonly used to heat solids. Their use in heating liquids is limited due to potential hazards. Heating liquids with Bunsen burners can lead to violent bumping and foaming. This bumping and foaming can lead to flashovers. In general, never heat flammable liquids with Bunsen burners. When using Bunsen burners, be certain there are no flammable solids, liquids, or vapors in the vicinity.

B. Steam bath

Steam baths are an inexpensive and useful way for heating mixtures up to 100 Celsius. Steam baths can also be used to heat mixtures from 50 to 90 Celsius. Steam baths are very easy to use and operate, and they heat mixtures without blind spots. Blind spots occur when heating is not even. A steam bath is much more useful for heating low-boiling liquids than a free flame, and any vapors which may escape from the distillation apparatus simply dissipate with the steam.

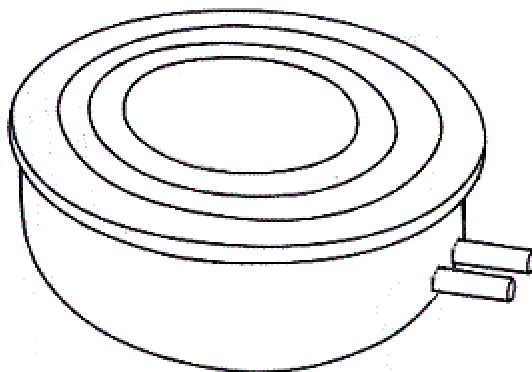

Figure 004. A common steam bath. To use a steam bath, remove enough rings so that a round-bottom flask will rest on a ring enough so to expose it to the steam without falling through.

C. Oil bath

Oil baths are useful for heating mixtures. The contact of the flask with the hot oil heats the flask perfectly because the hot oil completely surrounds the sides of the flask. This results in even heating and effective temperature control. Oil baths are relatively inexpensive and are safe to operate because they lack an open flame. Oil baths are slow to heat, and they cool slowly after use. These are some of the drawbacks associated with oil baths. In addition, the flask retains an oily residue, which is slippery and must be cleaned off.

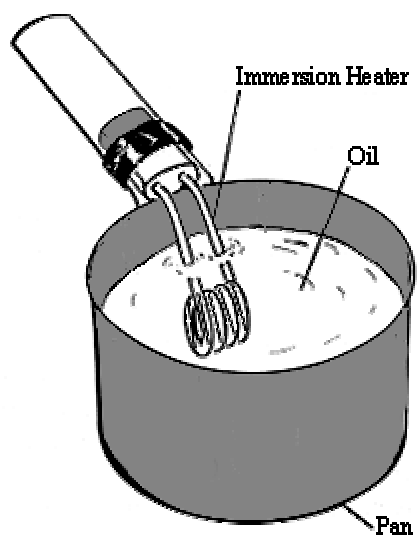

Figure 005. A typical immersion heater used with an oil bath. The flask is immersed about half way into the oil

D. Electric Heating Mantles

Heating mantles are the most common method of heating round bottom glassware, and they come in a wide variety of shapes and sizes. Sizes ranging from 10 milliliters to a whopping 12 liters are available. The most common sizes are the 250 milliliter, 500 milliliter, and 1000 milliliter models. These models range in price from 80 to 200 dollars. A voltage regulator is usually used to control the heating, and is sold separately. Exercise care in setting the voltage of a heating mantle because too much voltage can lead to undesired temperature. Test the voltage regulator on an empty flask equipped with a thermometer to familiarize you with the temperature settings. Some voltage regulators will clearly indicate the temperature. A label is usually attached to the heating mantle, which indicates the maximum safe voltage. Note: A heating mantle designed to tolerate a maximum of 20 volts quickly burns out if 120 volts is applied. Read the maximum tolerances aloud for your heating mantle before using it.

Most 100 to 500 milliliter heating mantles tolerate a full 120-volt input, and some large mantles even require two voltage regulators. On a final note, be certain the heating mantles size is appropriate for the flask being used.

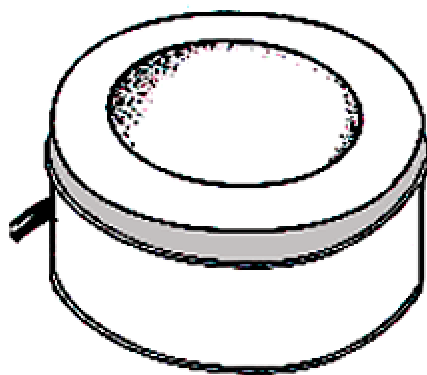

Figure 006. A classic heating mantle.

E. Hot Plates

Hot plates are by far the most common method of heating flat bottom laboratory glassware. Hotplates are exclusively used in heating Erlenmeyer flasks and beakers. Many hot plates come doubled with a magnetic stirrer and are usually called hot plate/stirrers. These hot plate/stirrers are very useful in the heating and the simultaneous mixing of liquids. Some hot plates come without magnetic stirrers. Laboratory hotplates heat relatively slow and they cool slowly, but their energy efficient and they maintain the desired temperatures for indefinite time.

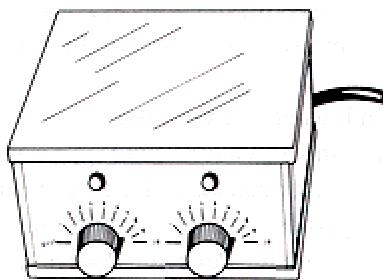

Figure 007 A common hot plate with a magnetic stirrer. Most hot plates double as magnetic stirrers.

4. Methods of Cooling

Cooling is often required during a chemical reaction in order to maintain proper reaction temperatures. Not properly cooling reaction mixtures can lead to conditions including evolution of poisonous gases, decomposition of products, and unwanted side reactions. Many of the procedures in this book require the use of cold-water baths, and ice baths. Cooling baths are cheap and readily available. Dry ice is readily available and is used to make excellent cooling baths.

Chapter 2: Laboratory techniques, and procedures

Cooling is not as easy as it may appear. In some ice baths the ice will melt rapidly during the chemical reaction. Ice that rapidly melts must be continuously refilled in order to maintain proper reaction temperature.

Cooling baths should be at least three times the volume of the reaction flask. For example, if using a 1-liter flask to contain the reaction mixture, a 3-liter container should be used to house the 1-liter flask. Before adding the cooling agent (ice water, ice, or dry ice) to the bath, make sure the 1-liter flask is seated in the bath container. Then fill the container with the cooling agent. The 1-liter flask should be submerged as far as possible into the ice bath. In other words, 80% of the total height of the 1-liter flask should be submerged in the cooling bath. In some cases the flask being cooled will displace the cooling agent (cold water, or ice water) causing it to float and possibly tip over. Lead rings, which are cheap and commercially available, make useful weights to keep the reaction flask seated in the cooling bath.

A. Cold water bath

Simple cooling utilizes a cold-water bath. Cold-water baths are used to keep the reaction temperature from 15 to 50 Celsius. In some cases the water bath will have to be quickly drained, and then refilled with cold water in order to maintain the desired reaction temperature. In most cases cold-water baths are used for general long-term temperature control.

B. Ice water bath

Ice water baths are commonly used to keep reaction temperatures around 5 to 30 Celsius. Ice water baths are used in place of cold-water baths where long term cooling, but a slight colder temperature is needed.

C. Standard ice bath

The standard ice bath is the most common method of cooling reaction mixtures. This method of cooling can produce temperatures of 0 to 20 Celsius. Ice baths are composed of chopped up pieces of ice, and the ice should be finely crushed so that it adheres to the wall of the reaction flask as much as possible. Remember to place the reaction flask into the empty bath container before adding the ice. As the cooling proceeds the ice may melt rapidly, moderately, or slow. If the ice is melted, drain off the water and then add more finely crushed ice. Continue the process as many times as needed. Depending on the time and conditions, the ice may not have to be replaced.

D. Salt/ice bath

The salt/ice bath is a modified version of the ice bath. Depending on the type of salt used, salt/ice baths are very useful for producing temperatures ranging from -55 to 0 Celsius. To prepare a salt/ice bath, simply mix the finely crushed ice with 20% of its weight in salt. Salt/ice baths can maintain their temperatures for varying amounts of time depending on the heat evolved during a particular chemical reaction, time, and/or other conditions. In some procedures the salt/ice bath will have to be replaced with a fresh batch. When the salt used is potassium chloride the temperature achieved will be around -10 to 0 Celsius. When the salt used is sodium chloride the temperature achieved will be -20 to 0 Celsius. When the salt used is anhydrous magnesium chloride the temperature achieved will be -30 to 0 Celsius, and when the salt used is calcium chloride hexahydrate the temperature achieved will be -55 to 0 Celsius.

E. Dry ice/acetone bath

Dry ice baths are very common in the modern laboratory. Dry ice is readily available and can achieve temperatures of -70 to -30 Celsius. Dry ice is seldom used along for cooling purposes due to its volatility. It is usually used in combination with a solvent. The solvent is normally acetone, but ethanol, ethyl acetate, or ether can be used. To use a dry ice/acetone bath, add the dry ice to its same weight in acetone (50/50) and then place this mixture into the bath container. Then place this dry ice/acetone filled bath container into a second yet larger container and then fill this second larger container with ice/salt. The second container bath acts like an insulator to the inner bath container giving longer life to the dry ice/acetone bath. The dry ice bath may rapidly deplete if you withhold the second cooling bath. For short-term cooling and use, the second cooling bath will not be needed. For long term cooling, withhold the second cooling bath and place the dry ice/acetone bath into a refrigerator freezer.

F. Cooling tricks of the trade

One method of cooling is to place the reaction apparatus into a refrigerator or freezer (as long as the apparatus can fit). This allows for complete cooling without refilling containers with ice or cold water. A major draw back to doing this is a lack of ventilation. In some procedures highly poisonous and corrosive gases are evolved and hence must be properly vented. If a procedure is relatively free from toxic or corrosive emissions, the apparatus can be placed into a freezer or refrigerator if it fits.

Refrigerators and freezers are also very handy when having to store reaction mixtures for several hours or several days. Simply place the reaction flask into the refrigerator or freezer and then cool for the amount of time needed. This eliminates the need for ice baths and the like.

5. Extraction

Extraction is a major part of many chemical procedures, and is usually conducted before the recrystallization process. Extraction is used to “separate” a product from a reaction mixture. The reaction mixture is merely shaken with a certain solvent multiple times. During this shaking, the desired product in the reaction mixture is dissolved into the solvent. The solvent is then removed from the reaction mixture, and the product recrystallized from the solvent.

The volume of solvent used is dependent on the desired products solubility in it. When the volume of the solvent has been determined, it is broken into small portions, and then each portion is shaken with the reaction mixture independently. After all the portions have been shaken with the reaction mixture, they are combined and then the product is recrystallized. For the chemical procedures in this manual, the solvent, quantity, and volume size of each portion is given in detail.

A. Funnel Size

The size of the separatory funnel is of practical consideration when carrying out the extraction process. A separatory funnel is the piece of glass traditionally used in extraction. In order to leave room for shaking the solution the funnel should be 30 to 50% larger than the total combined volume of liquid. For example, use a 250-milliliter separatory funnel when extracting 100 milliliters of reaction mixture with 50 milliliters of solvent. If you are extracting large volumes of liquid, and you don't have a proper sized separatory funnel, simply divide the reaction mixture into smaller portions and do the same for the solvent portions.



Figure 008. A standard laboratory separatory funnel.

B. Performing the Extraction

The first step in extraction is to pour the reaction mixture and the solvent into the separatory funnel. A two-layer mixture will result. Which layer is what depends on the densities of the chemicals in the reaction mixture versus the density of the solvent. If the density of the solvent is greater than the chemicals in the reaction mixture, the solvent will be the bottom layer. If the opposite is true, the solvent will be the upper layer. For example, when a water solution is to be extracted with two portions of methylene chloride, the water solution and the first portion of methylene chloride are placed into the separatory funnel (make sure the stopcock is closed). A two-layer mixture results. The methylene chloride will be the bottom layer because methylene chloride is denser than water. Then shake the mixture for several minutes. Afterwards, drain-off the bottom methylene chloride layer only, leaving the water solution in the separatory funnel. After the bottom methylene chloride layer is removed, pour the second methylene chloride portion into the separatory funnel and then begin shaking. Then once again, drain-off the bottom methylene chloride layer. At this point the water solution has been successfully extracted. Both drained-off methylene chloride portions can then be combined (if not already done so), and the product recrystallized. Note: If sulfuric acid is present in the reaction mixture, the methylene chloride will always be the upper layer. Sulfuric acid is denser than methylene chloride. Which layer is what will be described for each extraction process in this book.

Certain solvent combinations (a water solution of sodium hydroxide and chloroform) lead to emulsions when shaken together. Emulsification cannot always be anticipated, so choose the solvent wisely, or wait along time after shaking for the emulsion to dissipate.

1. Place the reaction mixture to be extracted into a separatory funnel (make sure the bottom stopcock is closed).
2. Add the solvent portion slowly to the separatory funnel.
3. Stopper the separatory funnel, and then begin shaking the funnel for a few minutes.
4. After shaking for a few minutes, allow the two layers to completely settle, and then properly vent the funnel as shown in figure 009. Then slightly open the bottom stopcock and slowly drain-off the bottom layer. If the upper layer is the solvent, the bottom reaction mixture layer will have to be drained off first, and then poured back into the same separatory funnel after the upper solvent layer has been drained off. If the bottom layer is the solvent, simply drain it off only, and leave the upper reaction mixture layer.
5. After the appropriate layer or layers have been drained off, and the reaction mixture is the only liquid in the separatory funnel, add the second portion of the solvent and repeat steps 1 through 5.
6. Repeat steps 1 through 5 as many times indicated in the procedure. For example, if an extraction calls for three portions of methylene chloride, conduct steps 1 through 5 three times.
7. After the number of extractions has been completed, combine all drained-off solvent portions (if not already done so).

Note: In some cases the reaction mixture will be very dark in appearance, and when extracted, forms another dark appearance with the solvent making the phase boundary between upper and bottom layers hard to see. If this happens, hold the separatory funnel up to a light, or use a flashlight.

Note: While shaking the funnel, vapors from the reaction mixture and/or solvent can increase pressure inside the separatory funnel. Proper venting of the separatory funnel is necessary in order to relieve this pressure. To properly vent a separatory funnel, rest the funnel in one hand while grasping the glass stopper. Then tilt the funnel so that the stopcock end is pointed up and away from anyone including yourself. After which rotate the stopcock to the open position. Be certain that the level of the liquid is below the stopcock opening so that none is forced out when the stopcock is opened.

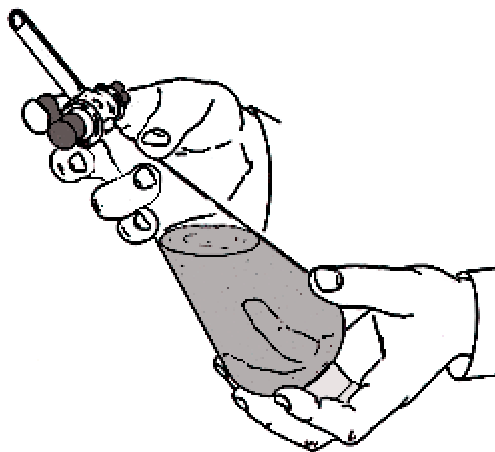

Figure 009. Correct way of venting a separatory funnel.

C. Draining the funnel

After shaking the funnel, the layer or layers must be drained off. To do this, simply place the separatory funnel into a ring stand supported by a base support. The stopper must be off in order to drain the funnel, and before opening the stopcock remove the stopper. Attempting to drain the funnel before removing the stopper can result in a vacuum making it difficult to remove the stopper.

When draining the bottom layer, the speed should be adequate as to not over drain. Over draining means to accidentally drain-off some the upper layer. The opening of the stopcock (either fully or partially open) is determined as the phase boundary of the upper liquid approaches the stopcock. When the phase boundary is far away, draining can be done rapidly. When the phase boundary approaches the stopcock, the drain speed should be reduced to a drip.

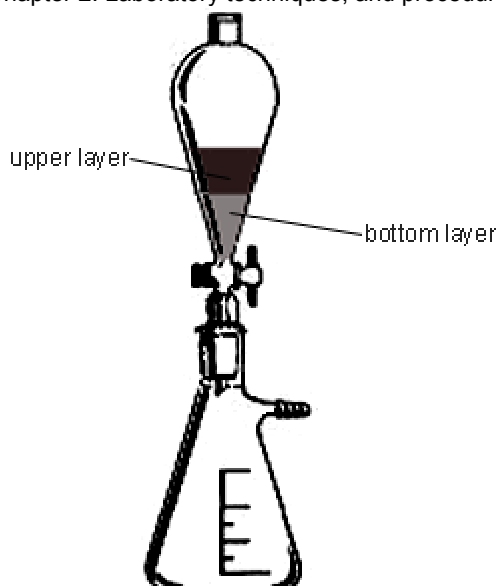

Figure 010. Separatory funnel positioned for draining.

D. Salting Out

In some cases, an organic compound (usually a liquid) dissolved in water can be precipitated by the addition of sodium chloride, sodium sulfate, or magnesium sulfate. These salts have a much higher affinity for water than most organic compounds, so they tend to dissolve in the water leaving the dissolved organic compound with no room to remain dissolved. The lack of space causes the organic compound to precipitate (organic liquids form a second layer). Water solutions of isopropyl alcohol for example, can be salted out by the addition of sodium chloride to the mixture followed by rapid shaking of the mixture. The quantity of sodium chloride used is determined by the alcohol concentration. The weaker the concentration is, the more salt is needed. After shaking, a two-layer mixture results. The isopropyl alcohol will be the top layer, and the brine solution the bottom.

6. Recrystallization, product recovery, and filtration

Recrystallization is a very important tool for purifying solids. In recrystallization, solubility differences allow solids to be separated from each other and recovered from the solvent. In the recrystallization process, molecules slowly deposit from solution and attach to each other to form crystals. As the aggregates of crystals grow large enough, they precipitate. After precipitation, the solids can be recovered by filtering them off.

Choosing the appropriate solvent is the most crucial aspect of the recrystallization process. The best solvent for recrystallization is one in which the material is less soluble at room temperature but more soluble when hot. At higher temperatures, solvents that form super saturated solutions with certain solids meet this requirement.

Solvent choice is also governed by another important factor, the ease of solvent removal. Solvents with low boiling points are preferred because their removal is easy. A third consideration in selecting a solvent is the temperature at which the solvent solidifies. Benzene was once widely used in recrystallization, but when placed in an ice bath, crystals of benzene would also precipitate (benzene crystallizes at 6 Celsius). A final consideration in choosing a solvent is reactivity. Obviously a solvent that reacts with a solid cannot be used for recrystallization.

Recrystallization depends on super saturation. Super saturated solutions are formed when mixtures containing the dissolved solid and the solvent (or solvent mixture) are heated, or evaporated. When the mixture is heated, the solvent begins to evaporate, as the evaporation proceeds, the concentration of the dissolved solid(s) begins to increase. During this evaporation, the solids become *over dissolved* leading to the super saturated solution. When tiny crystals start forming on the surface of the mixture during heating, super saturation has been reached. When the supersaturated solution is cooled, recrystallization begins and some of the dissolved solid precipitates as crystals. Not all the solid will precipitate out on cooling. After the supersaturated solution has cooled for some time, equilibrium sets in restoring the original solubility of the mixture. The only difference is that some of the solvent and solid have been removed. The precipitated crystals are then collected by filtering the mixture. To recover more solid, the mixture must be re-heated and allowed to evaporate to the point of super saturation again.

A. The Recrystallization Process

Chapter 2: Laboratory techniques, and procedures

The recrystallization process is simple. Boil the mixture that contains the dissolved product and the solvent (or solvent mixture). The mixture can be placed into a distillation apparatus and distilled at the boiling point of the solvent to collect the solvent. Using a distillation apparatus is preferred rather than just boiling-off the solvent, which would be a waste of solvent. Boil off the solvent until super saturation is achieved. When tiny crystals begin to form on the surface of the mixture, super saturation has been achieved. Then remove the heat source (turn off the heat source) and allow the mixture to cool to room temperature. Afterwards, place the mixture into a cold-water bath or ice bath for thirty minutes. After which, remove the cooling bath, and then filter-off any precipitated product. Then place the filtered mixture back into the same distillation apparatus, and re-distill again until a super saturated solution is achieved. When super saturation is achieved, remove the heat source, and allow the mixture to cool to room temperature. Afterwards, place the mixture into a cold-water bath or ice bath for thirty minutes. Then remove the cooling bath, and then filter-off any precipitated product. Then place the filtered mixture back into the same distillation apparatus, and distill until a super saturated solution is achieved. When it is achieved, remove the heat source, and allow the mixture to cool to room temperature. After which, place the mixture into a cold-water bath or ice bath for thirty minutes. Then filter-off any precipitated product. At this point much of the solvent has been removed by distillation, and much of the product has been recovered. The remaining mixture is called the mother liquor, and can be recycled to a future recrystallization of the same product (using the same solvent or solvent mixture). This process of boiling, cooling, and filtering should be repeated as many times as necessary. When recrystallizing a product from a solvent or solvent mixture, continue the process until 90% of the solvent has been removed. Depending on the solubility of the product, continue the recrystallization process until 75 to 98% of the solvent has been removed. After most of the product has been collected, it can then be washed. To wash a solid product, simply leave it in the filtering funnel, and then pass an inert solvent over it many times. Choose a solvent that does not dissolve the product. Water is usually used to wash organic solids.

B. Seed Crystals

In some cases recrystallization of super saturated solutions can be initiated with a seed crystal. A seed crystal is simply a small crystal of the product. It is added to the super saturated solution, and the dissolved product begins to grow on the seed crystal. The seed crystal induces recrystallization by giving the dissolved product a surface from which to grow on. The recrystallization of the product stops when equilibrium of the solution is reached.

C. Recovering the product through low heat or no heat evaporation

In most modern labs, the recrystallization process is passed over by a rotary evaporator. A rotary evaporator, as pictured in figure 003, is the most common method of recovering dissolved product. To use, the reaction mixture is placed there into, and then a vacuum is applied. The flask containing the reaction mixture is partly submerged in a water bath, and the necessary amount of heat is applied. Because liquids have decreased boiling points with decreasing pressure, solvents can be removed at much lower temperatures thanks to the vacuum. This process is similar to vacuum distillation. The great thing about rotary evaporators is their ability to run for hours on end without having to interact, monitor, or take part in the process. Simply insert the reaction mixture, apply the necessary heat, attach the vacuum, and let the machine do the rest of the work. Rotary evaporators sell for about \$3,000 to \$10,000 a piece.

The oldest method of product recovery is placing the reaction mixture into a crystallizing dish, or shallow pan, and then allowing the solvent(s) to air evaporate. This method is a good idea for crystallizing stable, light insensitive products, where good crystal size is desired; for example, allowing a solution containing sodium chlorate to air-evaporate, large brilliant crystals of the chlorate are obtained. If this same solution was recrystallized, or evaporated under vacuum, usually small crystals of the chlorate are obtained. The problem with air-evaporation is the amount of time required, especially if the product is hygroscopic. In some examples, air-evaporation is impossible. Examples include zinc chloride, lithium perchlorate, and calcium chloride. These substances are so hygroscopic that placing the dry crystals into a beaker will produce a self-induced aqueous solution on standing after several days or weeks due to moisture absorption from the air. In warm dry climates, such as desert climates, air-evaporation has its advantages. Good crystal size can be rapidly achieved by allowing reaction mixtures to air-evaporate in the sunlight.

D. Filtration

Filtration and recrystallization run hand in hand. When a product precipitates, it must be collected. Filtration is the most common method of collecting precipitated products. The two methods of filtration include gravity, and vacuum. Vacuum filtration is the most common method of filtering in the lab, and it is also the fastest.

E. Gravity filtration

Gravity filtration is the oldest and slowest method of filtering. In most regards gravity filtration should be avoided due to the slow nature. In many examples gravity filtration can take hours, and even days. Even so, gravity filtration is useful for removing charcoal, which is difficult to remove from mixtures when using vacuum filtration.

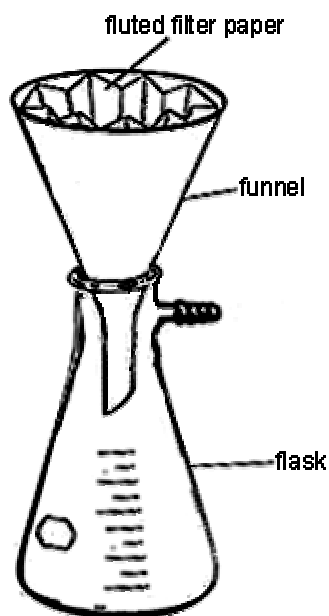

Figure 011. Apparatus for gravity filtration.

Gravity filtration is sometimes used to remove impurities rather than to collect a precipitated product. In this case the filtration takes place with the use of a filter aid. A filter aid is an insoluble substance used to absorb impurities. Some examples of filter aids include Celite, silicon dioxide, sand, zeolites, and even pebbles. Celite is a diatomaceous earth material that is most commonly used. Although filter aids can be used to speed up the filtration of finely divided precipitates, which otherwise get stuck in the tiny holes of the filter paper.

F. Fluting Filter Paper

Laboratory filter paper used in modern labs is usually circular in nature, so fluting the paper is necessary. Fluted filter paper is superior to flat filter paper because fluted filter paper allows for better airflow between the funnel wall and the fluted filter paper.

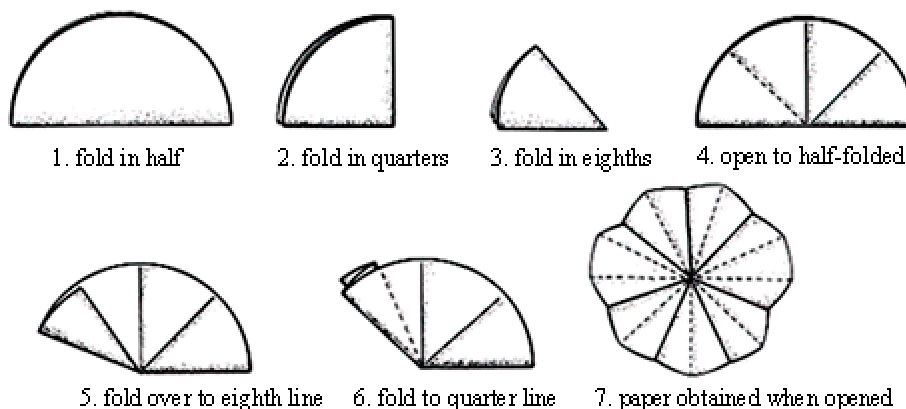

Figure 0012. Fluting filter paper.

G. Vacuum Filtration

Vacuum filtration is definitely the method of choice for filtration, and it is the most common method. Vacuum filtration is superior in that suction is used to force the liquid through the filter paper allowing for rapid filtration. Precipitates can be recovered quickly and easily. After the precipitate has been recovered, it can then be vacuum dried. Vacuum drying is simply

allowing suction to continue after the liquid has been removed. The suction creates an excellent airflow, which dries the collected precipitate as it flows. Ten to twenty minutes is adequate time to dry any product.

When first starting the filtration process, the vacuum will suck some of the product into the flask. The contents of the flask should then be re-filtered to ensure no product loss. The suction force is generated by a vacuum pump, which is commercially available in many styles and sizes; hand driven pumps can be used as well. Note: The suction force should not be too great. Placing your hand completely over the funnel until the suction grips your hand moderately indicates the proper suction. Never underestimate the power of a vacuum.

A Buchner funnel is used in vacuum filtration, and is a glass or plastic funnel. Plastic Buchner funnels are composed of two pieces. The funnel cup makes up the top piece, and the stem makes up the bottom piece. Glass Buchner funnels are composed of one or two pieces, and some come with glass joints. To use the funnel simply attach it to the filtering flask (see illustration below), and then place a piece of round filter paper into the bottom of the funnel. The filter paper is simply held in place by gravity and the suction force. Before filtration begins, lightly moisten the filter paper with water or fresh solvent (the solvent used should be the same as in the mixture being filtered, or an inert solvent that does not dissolve the precipitate). Once the precipitate has been filtered and dried, simply remove the suction source and then casually remove the filter paper from the Buchner funnel. Then gently scrape off the product from the filter paper.

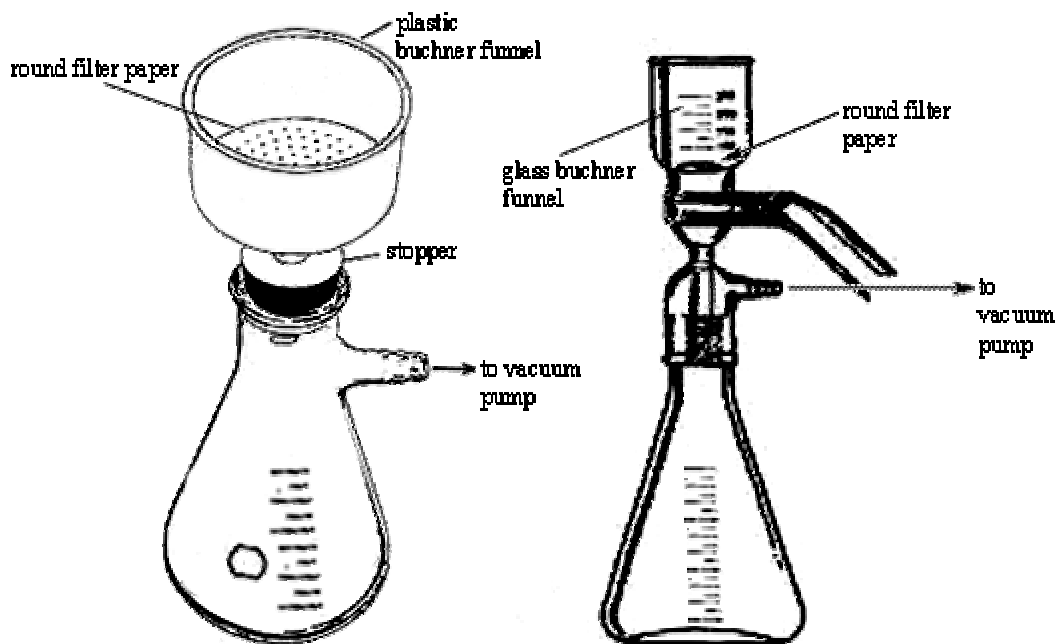

Figure 013. Left: Plastic buchner funnel. Right: All glass set-up.

7. Washing liquids and solids

Solids are easily washed by passing water, or the desired solvent over the solid product, which is contained in the filter funnel. For washing solids in this way, vacuum filtration should be used. Washing solids in this way using gravity filtration is a long and time consuming process. Obviously, do not wash the filtered-off solid with any liquid that reacts with, or dissolves the solid product.

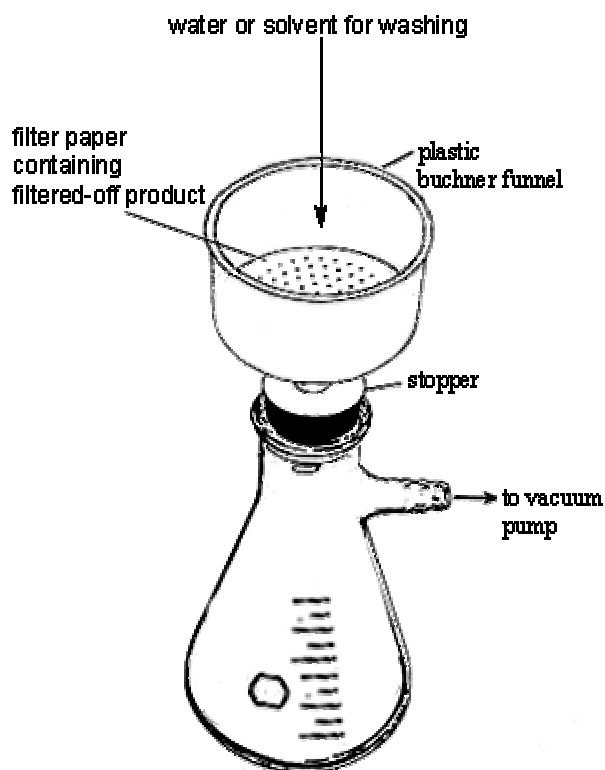

Figure 014. Washing a solid product.

Another method of washing a solid product is to place it into a beaker, and then add an excess of water or solvent, stirring the mixture for several minutes, and then allowing the mixture to stand long enough for the solid product to settle. After the solid product settles, much of the water above the settled solid product can be removed by carefully tilting the beaker, and pouring it off. This method of washing is useful for washing large amounts of water insoluble solid product.

Washing liquids is done in a similar manner as just described. For washing a liquid, usually with water, place the liquid into a beaker, and then add the desired amount of water. Thereafter, stir the mixture for several minutes, and then allow the mixture to stand. After the two-phase mixture has settled, remove the water layer either by using a separatory funnel, or by pouring it off.

8. Drying agents and drying liquids

Water is called the universal solvent, but in many cases its considered to be an impurity. After the extraction process, the combined solvent portions sometimes contain a small amount of water. This water is removed by treating the combined solvent portions with an inert drying agent. The drying agent simply absorbs the water. The most commonly used drying agents are listed below.

A. Anhydrous sodium sulfate

Anhydrous sodium sulfate is the most common general-purpose drying agent. It is inexpensive and has a very large capacity of absorption because it can form a decahydrate. Anhydrous sodium sulfate is relatively inert, and it does not react with most organic compounds. Anhydrous sodium sulfate can be regenerated from used sodium sulfate by heating to 200 Celsius for 1 hour.

B. Anhydrous magnesium sulfate

Anhydrous magnesium sulfate is the second most commonly used drying agent. Similar to anhydrous sodium sulfate, it to has a high capacity for absorption, and low cost. Although unlike anhydrous sodium sulfate, it has a faster drying rate, but is more reactive. It can be regenerated in the same manner as anhydrous sodium sulfate.

C. Calcium chloride

Calcium chloride is very inexpensive, and is an excellent drying agent. Its very high capacity and rapid drying ability make it the reagent of choice for drying hydrocarbons, chlorinated solvents, halogens, and ethers. Unfortunately, calcium chloride is much more reactive than either sodium or magnesium sulfate and thus cannot be used to dry amines, alcohols, acid gases, or ammonia. It can be regenerated in a similar manner as anhydrous sodium sulfate.

9. Distillation

Distillation is a very common method for purifying liquids. Atmospheric distillation (general distillation), Vacuum distillation, and steam distillation are the three common methods of distillation. Atmospheric distillation takes place at atmospheric pressure, which means the distillation apparatus is open to the air. Vacuum distillation utilizes reduced pressure to distill a liquid at lower temperature. Vacuum distillation is commonly used to distill liquids, which tend to decompose at their atmospheric boiling points. Vacuum distillation is also used to conveniently distill liquids with relatively high boiling points at a much more efficient temperature. Steam distillation is similar to atmospheric distillation, but steam is used to promote volatility. Steam distillation only works on liquids or solids which are volatile with steam.

A. Atmospheric Distillation (general distillation)

Atmospheric distillation is the most common of the three methods of distillation. Figure 015 illustrates a common distillation apparatus. When liquids are heated they become volatile. The degree of volatility depends on the amount of heat applied to the liquid, the pressure, and the chemicals boiling point. When enough heat is applied to the liquid, the liquid begins to boil. When a liquid boils, intermolecular forces within the liquid break, and the molecules there after convert into the gas phase. During the distillation, this gas passes over into a condenser, where it is condensed back into a liquid by applying a cooler temperature to the gas. A condenser usually filled with circulating cold water acts as the cooling force. When the gas is cooled, it reforms back into a liquid, and then gravity pulls it into a receiver flask where it collects. A typical distillation produces 1 to 50 milliliters of liquid per minute. Most distillations take hours, depending upon the volume of liquid being distilled, and the concentration. Concentrated solutions distill much faster than dilute ones.

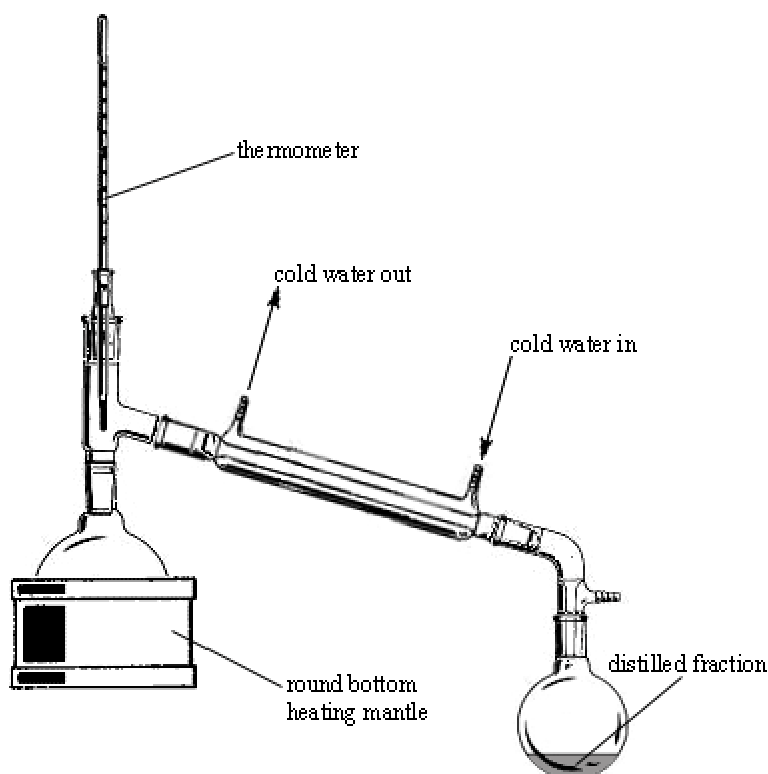

Figure 015. Atmospheric distillation apparatus.

B. Vacuum Distillation

Vacuum distillation is another common method of distillation in modern labs. Figure 016 illustrates a common vacuum distillation apparatus. Vacuum distillation takes advantage of the volatility of liquids by reducing pressure. The boiling points of liquids decrease with decreasing pressure, so distillation of heat sensitive liquids can be carried out at lower temperatures.

Some liquids begin to decompose at their atmospheric boiling points, so purification using general distillation will not work. Vacuum distillation is also commonly used for distilling liquids at lower temperatures.

When a vacuum is applied to the apparatus, reduced pressure forces the liquid or liquids to volatilize much more readily. As a result, less heat is needed to force the liquid or liquids into the gas phase. For example, at sea level (atmospheric pressure), water boils at 100 Celsius, but at 15,000 feet water boils at 92 Celsius. It is possible to reduce the pressure of a distillation apparatus to a point where water boils at 50 Celsius. Nevertheless, when using laboratory glassware, the strength of the vacuum is limited. An absolute vacuum using lab glass is impossible due to outside forces. If we applied an absolute vacuum to a glass distillation apparatus, it would implode. Vacuums as low as 0.01 millimeters of mercury are possible using thick walled stainless metal apparatus.

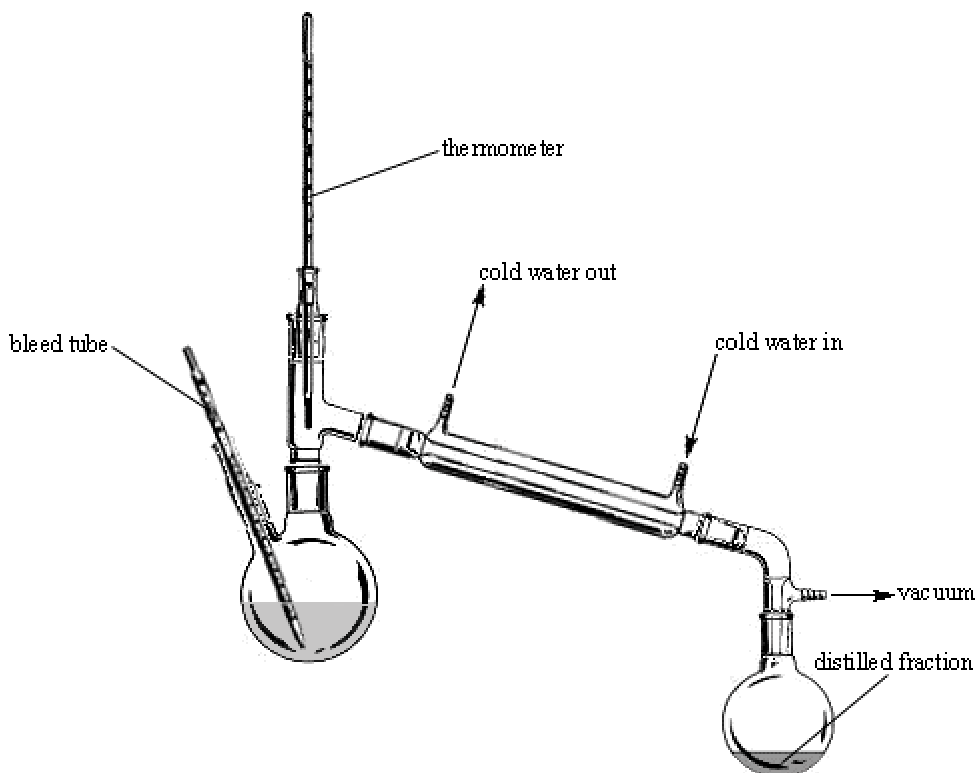

Figure 016. A standard vacuum distillation apparatus. The bleed tube allows for pressure equalization, and allows for faster distillation; as air passes through the mixture, it carries away some of the solvent.

C. Steam Distillation

Steam distillation is the third most common method of distillation. Figure 017 illustrates a common steam distillation apparatus. Steam distillation takes advantage of the volatility force of water upon certain solids or liquids. Many liquids and solids are volatile with steam, which means they partially volatilize when contacted with steam without actually converting to gas. The steam merely acts as a carrier picking up the solids or liquids, and then carrying them over in a conventional distillation manner. The products being steam distilled, whether soluble in water or not, are collected in the receiver flask. Steam distillation works by the interference of hot gases upon solids or liquids. The solids partially volatilize forming finely divided micro particles, and liquids partially volatilize forming micro sized droplets of liquid (a mist). The gaseous water then takes-up these finely divided micro particles or small droplets of liquid, and carries them over in a conventional distillation manner. Think of smoke for example, it appears to be a smooth flowing gas when actually it's a mixture of finely divided micro particles mixed in with colorless gases.

Most steam distillation apparatuses generate their steam internally, but some use steam provided from a steam line.

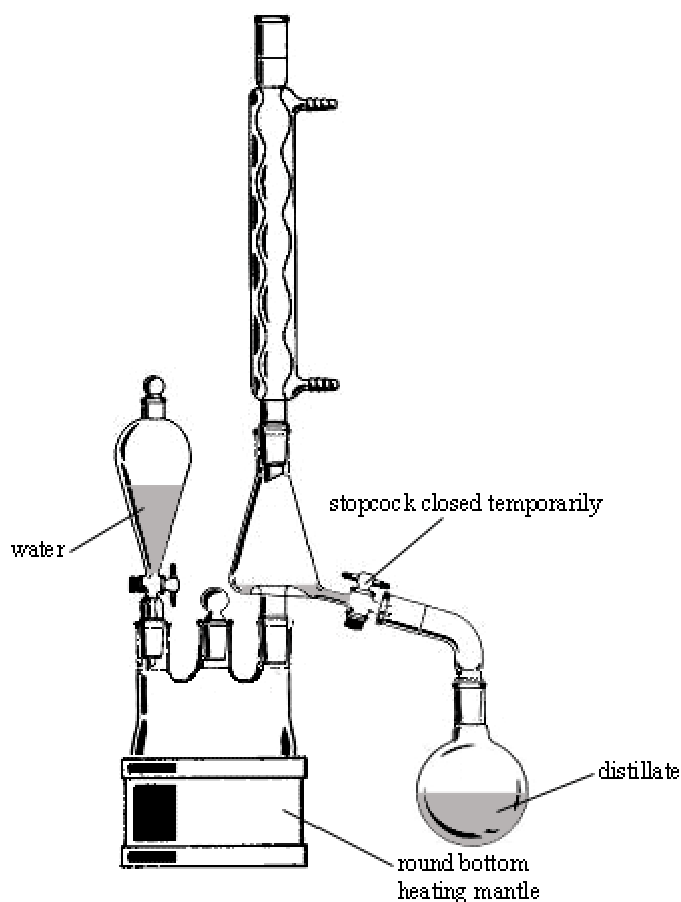

Figure 017. Common steam distillation apparatus with steam generated internally.

Note: All the glassware represented in the illustrations can be purchased from *Lab Glass Inc. PO Box 688, Buena, NJ 08310 USA*. Lab Glass is by far one of the best manufacturers and suppliers of laboratory glassware in North America—this is not an advertisement for Lab Glass, just merely a professional opinion.

10. Final Lesson: A tutorial on explosives

Introduction

The world of explosives can be an exciting and dangerous world. Not only do explosives bring death and destruction in times of war, but prosperity and growth in times of peace. Explosives are used in many types of operations, for example, they save hundreds of thousands of man-hours in labor and millions in engineering costs. The money and resources saved by explosives allows for safer construction and deconstruction, processing and management, technological growth, and economic expansion. Before pursuing any operation using explosives, a few simple yet vital rules should followed: 1) Explosives should be made in small quantities, and by qualified and trained personnel only. 2) Proper lab safety should be practiced at all times. Examples include, proper ventilation, blast shielding, and proper handling of chemicals. 3) Always remember that high explosives are very powerful, and therefore easily capable of causing bodily injury or death. Remember to never heat explosives if not called for in the procedures, and never experiment with them by heating, mixing, or treating them with other chemicals unless described in chemical procedures. Never heat high explosives in a microwave or other heating device unless called for by procedures. Never burn the high explosives, or expose them to direct flames, sparks, electric discharges, or other methods of ignition. 4) Never store primary explosives in large quantities, and never store them dry. Lead azide, lead styphnate, diazodinitrophenol, ammonium picrate, ammonium picramate, and sodium picramate are examples of primary explosives—primary explosives will be clearly identified in the procedures when they are dealt with. 5) Most high explosives are poisonous compounds. Do not handle them with bare hands or consume beverages or foodstuffs that may be contaminated. Wash hands thoroughly after touching high explosives with bare hands, because the skin can absorb them (especially skin that contains sweat). 6) Many high explosives produce highly toxic fumes when detonated (especially the polynitro explosives). Do not detonate high explosives in poorly ventilated areas (sealed rooms or buildings) if you're in the area. 7) High explosives produce very violent and destructive pressure waves upon detonation. When detonating high explosives, maintain a safe distance behind

cover; minimum safe distance: 10 centimeters per 1 gram TNT equivalent, 50 meters minimum safe distance per 500 grams TNT equivalent. In most cases, greater distance should be practiced when dealing with quantities over 1 pound (500 grams). Personnel should not only remain at safe distances, but should position themselves behind secure objects such as concrete walls, boulders, mounds, sandbags, ect., ect. Remember that proper cover should be capable of withstanding a bullet (without penetration). Bushes, shrubs, grass, and similar entities do not count as cover. 8) The detonation of high explosives can propel missiles in any direction with tremendous force. These dangerous missiles include bomb fragments, rocks, wood debris, and/or debris from anything that may be in contact with the detonation. Note: Even body parts such as bone, and teeth can become lethal missiles; documented cases of soldiers being impaled by fellow soldier's bone's have been reported as have shrapnel wounds from flying teeth. Some of these injuries can be caused by small quantities of high explosives. On a lighter note, remember that movies, TV, and video games are fake; people don't go "flying" when an explosive blows up near them, nor do they get "thrown". Explosives cause pieces of flesh and body parts to go flying. 9) Wear proper ear protection when detonating high explosives, and never directly look at the detonations at night because high explosives emit very intense light upon detonation. This light is not apparent during the day, but becomes very visible at night. The strong, yet brief emissions of light caused by detonations can cause temporary blindness if looked at directly from a close distance. Note: concussion grenades use this intense light to confuse and disable enemy personnel. It should be noted, that concussion grenades only work in dark areas, and have no effect during the day or lighted areas.

10b. The dynamics of detonation

Detonation: A process which all explosives undergo, is a phenomenon that yields great energy. During a detonation, the molecules of the explosive break down forming products. These products include water, nitrogen, carbon dioxide, nitrogen oxides, and carbon. The carbon is easily observed after the detonation, and is evident by the black spot remaining on the ground (note: larger masses of explosives produce no visible "black spot" due to dust and debris which eliminates any evident charring or spotage. Small masses of explosives, from a grenade for example, produce a clear visible black spot upon detonation). Most of the products of detonation dissipate into the air, and give off characteristic odors of nitrogen oxides. These oxides can usually be smelled in the air after detonation, and the odors resemble that of chlorine and nitric acid. Overall, most explosives give off these characteristic odors, but some detonate relatively cleanly, yielding no noxious fumes. A few examples include: ammonium nitrate, lead azide, nitroglycerine, and silver fulminate.

When an explosive detonates, it undergoes a violent spontaneous decomposition. This spontaneous decomposition produces a matrix composed of uniform particles of gas and solid. The so-called matrix of gas and solid is generated by multiple chemical bonds breaking within the molecules of explosive. The active functional group within the explosives, i.e. the functional group of either nitro, nitroxy, nitrate, azide, chlorate, perchlorate, fulminate, and/or any combination thereof is what actually initiates the spontaneous decomposition of the entire molecule. For example, when the nitro functional group of an explosive is subjected to molecular shock, produced by the detonation of a blasting cap, detonator, or booster, the carbon-nitrogen-oxygen (the nitro group) bonds break, releasing energy. This energy then triggers the spontaneous decomposition of the rest of the molecule. The spontaneous chemical decomposition of the molecule is so rapid, that an overwhelming amount of energy is produced simultaneously (trillions of chemical bonds breaking and forming within milliseconds). This massive buildup of energy is rapidly and suddenly released into the surrounding environment in the form of a "pressure wave".

A pressure wave is a uniform, spherical pattern of super heated particles composed of gas and solid. The difference between the "matrix", and the "pressure wave" is that the matrix is a zone of high energy that only occupies an area just slightly larger than the exact volume of the explosive, milliseconds after detonation (the matrix can only be seen using super high speed cameras, and some professionals don't call it a "matrix"). In other words, the matrix is a zone of high energy that desperately wants to expand—so it does, at miraculous speeds—this violent expansion is carried out by the pressure wave. The pressure wave is called the pressure wave because that's basically what it is—a wave under pressure.

During the expansion, the pressure wave expands outwards in all directions covering a perfect 3-dimensional sphere—dependent on the exact shape of the main explosive body. The expansion force (pressure wave), has tremendous kinetic energy, and is capable of applying a great force upon anything in the way. As the pressure wave expands it reaches a maximum distance, whereby it sputters out of expansive energy, and then dissipates almost immediately. Note: a shock wave is caused by the super sonic motion of the pressure wave, and when the pressure wave reaches it's maximum distance, the shock wave is produced. The shock wave plays little role in the destructive nature of the detonation. For small detonations, the shock wave is hard to see, but with larger detonations, the shock wave is clearly visible especially when looking from higher altitudes.

The pressure wave, or expansion force will only expand to a limited distance from ground zero. The distance from ground zero to maximum expansion is called the "blast radius". A blast radius is the zone where the majority of destruction takes place during a detonation. Now it should be recognized that not all pressure waves travel at the same speed. The speed varies from 2,000 to 10,000 meters per second, depending on the explosives power, and the term "detonating velocity" refers to the relative speed that the pressure wave travels at. The detonating velocity of an explosive is calculated by determining how fast the pressure wave travels from ground zero to its maximum expansion distance. Obviously, the faster this expansion takes, the more powerful an explosive is. Note: the blast radius is also based on the mass of explosive used, but the detonating velocity is always constant regardless of mass. For example, 500 pounds of TNT will have a larger blast radius than say 50 pounds, but

the speed of the pressure wave is always constant. Note: Shape charges have a cylindrical blast area, and linear shape charges have a horizontal blast area—these two items will be discussed in detail shortly.

The maximum expansion distance is usually reached within milliseconds after detonation, and when the maximum distance is reached, the pressure wave is dissolved into the surrounding environment. The dissolving of the pressure wave into the surrounding environment is the result of several effects, one of which is a void, or vacuum that is produced in the center of the blast radius. This vacuum sucks in the surrounding environment causing the pressure wave to be dissolved. Several other key factors that determine the neutralization of the pressure wave include the outside forces of air, gravity, moisture, and atmospheric pressure. Note: for smaller explosions, the vacuum effect is not clearly seen, but it can be clearly visible with larger amounts of high explosives. Another, even better way to see this vacuum effect, is to study a nuclear detonation. The "vacuum" effect is clearly visible by nuclear detonations. The infamous "mushroom cloud" is primarily formed due to the vacuum produced after detonation. In this case, the vacuum is so powerful, that it actually causes a secondary "wave" (not a pressure wave), which is capable of causing great secondary destruction. In essence, this secondary wave is a reverse driving force that forces gas and solid backwards and upwards into the mushroom cloud.

For large explosions, like that from nuclear devices, the blast radius is not the only cause and effect for the destructive ability of the explosives. Another less common force that causes destruction is known as "high force winds". As previously mentioned, during a detonation, the pressure wave is what causes the bulk of destruction, and makes up the blast radius.

However, with excessively large amounts of explosives, such that from 10,000 pounds or more, high force winds are responsible along with the pressure wave for destructive potential. The high force winds are produced as a secondary energy that is the result of the pressure wave. These winds are generated by the pressure wave because the pressure wave is so large (not speed), that the surrounding air is compressed into a "third" wave (not a pressure wave), similar to a tidal wave of sorts. This tidal wave, or high force winds act like hurricanes in nature with wind speeds of up to 500 miles per hour. Detonations capable of producing these high force winds commonly come from nuclear type devices, rather than conventional high explosives.

Although this book discusses the chemistry of high explosives, it should be noted that in this section discussing the dynamics of detonation, nuclear devices should be briefly mentioned, as their detonations are of similar dynamics. The power of nuclear explosions is mind boggling, but unlike high explosives, nuclear detonations involve a different set of chemistry than that of high explosives. As discussed earlier, a detonation is a chemical process, involving the spontaneous decomposition of the explosives molecules. The decomposition involves the breaking and forming of trillions of chemical bonds; however, in a nuclear detonation, atoms, not molecules, are under going trillions of breakage and forming to form smaller or larger elements. The energy released by the breaking and forming of atoms, yields hundreds and thousands of times more energy than the breaking and forming of chemical bonds within an explosive molecule. For example, the detonation of plutonium, releases 10,000+ times more energy per gram, than the decomposition of TNT. Unlike TNT, plutonium undergoes "spontaneous nuclear fission" when detonated. In essence, the detonation of 1 kilogram of plutonium produces an explosion equaling 18,143,694 kilograms of TNT—with a blast radius of about 2 miles. As with conventional high explosives, nuclear detonations produce similar pressure waves, with high force winds also being generated. Because of the excessive amount of heat liberated during a nuclear detonation, the high force winds generated from the pressure wave upon detonation are capable of reaching temperatures of 600 to 900 Celsius. The hot high force winds are capable of charring and burning materials up to a mile or more from ground zero. High explosives also produce hot gases not only from the pressure wave, but also from high force winds—although these temperatures rarely do any damage, as they are very short lived. High force winds from nuclear detonations are capable of burning shadows into walls, stripping the paint of objects, fusing sand, and boiling water. Note: During the atom bomb drop on Hiroshima, it was discovered shortly thereafter, that several dozen Japanese were boiled alive like lobsters in a near-by swimming pool—none of these persons suffered from radiation contamination and no other visible wounds other than the exposure to boiling water. Note: Unlike certain Hollywood movies, people do not catch on fire as the result of a nuclear detonation.

10c. Detonation versus deflagration and combustion

Detonation, as described earlier, is a process where upon a matrix of uniform particles of gas and solid forms a pressure wave. The pressure wave is what causes the bulk of destruction. However, it should be noted that detonation is a completely different process than deflagration and combustion. As previously stated, compounds that detonate must possess certain functional groups. These functional groups are initiated by molecular shocks generated by blasting caps, detonators, and/or boosters. Of course not all explosives need to be initiated by blasting caps, detonators, and/or boosters; for example, primary explosives (which you will learn much about shortly) can be detonated under relatively easy means: by sparks, heat, friction, percussion, fire, and shock.

A. Deflagration: is the process of rapid and violent combustion, followed by rapid expansion of gas and solid. This rapid expansion of gas and solid is not a pressure wave. For example, when a mixture of potassium nitrate and sulfur is subjected to a flame, the mixture ignites and burns rapidly—this process of rapid ignition and burning is exactly what deflagration is. The combustion of gunpowder is another classic example of deflagration. Most deflagrations result from mixtures such as pyrotechnic compositions, but a few substances are capable of deflagrating on their own. Such examples include: ammonium or alkaline metal picramates, picrates, nitrocellulose, and nitro starch.

During a deflagration process, there must exist two primary components, i.e., the “oxidizer”, and the “combustible” or “reducing agent”. The oxidizer is the “oxygen” source, and the combustible or reducing agent, it the “fuel. When we take sodium chlorate for example, and place it into a tube, and then gently heat the chlorate to the point where it begins to melt, nothing really happens. However, if we add a piece of fruit, say a piece of apple or banana, a rapid and violent reaction results. What happens is oxygen from the chlorate, burns components within the fruit. This form of “burning” is found in other examples such as a mixture of sulfur, charcoal, and potassium nitrate (black powder). Black powder burns violently and rapidly when ignited because oxygen within the nitrate is chemically reacting with the sulfur and charcoal—the products of combustion are carbon dioxide, sulfur dioxide, and potassium oxide.

Note: "firework smell" comes from the production of sulfur dioxide produced by the deflagration of black powder. Ammonium nitrate pyrotechnic compositions are slowly replacing black powder in fireworks because ammonium nitrate produces relatively clean products of combustion (minus sulfur). Note: Black powder is classified as a “propellant”, not an explosive, and its detonating velocity is only a mere 400 meters per second. In fireworks, black powder usually deflagrates rather than detonates—depending on the type of firework involved.

The deflagration process is the most common method used by man for propelling or throwing objects. These propulsion forces are generated by tremendous pressure, not the forces generated by detonations. When black powder for example, is placed into a tube (sealed at one end), and a large object, such as a cannonball is then inserted, the cannonball is shot out of the tube upon ignition of the black powder. This whole scenario is caused by the tremendous pressure produced by the deflagration of the black powder. If we were to place black powder into a tube, and seal it at both ends, the ignition of the black powder would cause an explosion. In this scenario, the explosion is merely the result of tremendous pressure that ruptures the tube upon ignition of the black powder—the black powder deflagrates in the usual manner. The deflagration of compositions and the resulting pressures produced are the foundation for firearms of all types.

The deflagration process is not only crucial for propelling projectiles such as bullets, shells, ect., ect., but for propelling large objects such as missiles, rockets, and space craft. In this manner, the deflagration process is the same, but instead of the process taking place under confined conditions (as with ammunition), the pressures from the deflagration are channeled from the vessel, tube, or combustion chamber. There are literally tens of thousands of deflagration compositions ranging from simple black powder compositions, to high performance rocket propellants containing ammonium perchlorate, HMX, nitrocellulose, nitroglycerine and various other high explosives. In the case of high explosives being used in deflagration compositions, the high explosives are primarily the oxidizer and do not undergo detonation upon ignition. Note: deflagration compositions are not initiated by blasting caps, detonators, or boosters—they are initiated by simple pyrotechnic igniting compositions. Do not attempt to initiate any deflagrating composition using a blasting cap, detonator, or booster—as detonation will result.

B. The process of combustion: is a simple chemical reaction that also involves an oxidizer, and a fuel. For combustion, the fuel is usually paper, wood, charcoal, or any flammable substance. The oxidizer is always oxygen from the air. Combustion is merely a simple non-violent chemical reaction involving the fuel and the oxidizer, and from which carbon dioxide and water are usually the products—as with detonation and deflagration however, heat and light are also products. Even though deflagration is also a combustion process involving oxygen and a fuel, it differs from combustion by its violent nature—whereas combustion is more steady and even.

In review, explosives are compounds that undergo a process called “detonation”, “deflagration” is the process of violent combustion followed by rapid expansion of gas and solid, and “combustion” is a simple chemical reaction involving an oxidizer and a fuel. Examples of compounds that detonate are: HMX, RDX, TNT, picric acid, mercury fulminate, and lead styphnate. Examples of deflagration compositions include the oxidizers from the family of nitrites, nitrates, chlorites, chlorates, perchlorates, bromates, perbromates, iodates, periodates, chromates, dichromates, manganates, permanganates, dioxides, trioxides, tetraoxides, and pentoxides, when mixed with a suitable combustible or reducing agent from the family of sulfur, sulfides, hypophosphites, phosphites, finely divided metals, charcoal (of any type), finely divided carbohydrates, hydrides, paraffins, waxes, and any other combustible materials (when finely divided)—and any combination thereof.

10d. Primary, and secondary explosives

Unlike common myths, stereotypes, and Hollywood nonsense, most high explosives are very stable, and will not detonate even when subjected to violent actions such as fire, pressure, mild impacts, abrasions, cutting, friction, and so forth. However, some high explosives are not so stable, and are called “**primary explosives**”. The term “primary explosive” has nothing to do with the explosives power, and it strictly refers to explosives that are easily detonated. As such, all primary explosives are only used in small quantities, and in such a way so as to initiate other more stable explosives. This action of events is called an “explosive train”. Explosive trains exist mainly in blasting caps, detonators, fuses, and boosters. In short, primary explosives include the following: heavy metal fulminates, azides, ammonium salts of nitro phenyls, metal salts of nitro phenyls, azonitro phenyls, and ammonium or metal salts of nitrotriazoles and tetrazoles. This whole array of primary explosives are easily detonated by fire, sparks, heat, pressure, shock, and percussion. In a related example, when a small sample of mercury fulminate is placed onto a flat surface, it detonates when struck with a hammer. This type of action is commonly found in primers for bullets and ammunition—the firing pin strikes the primer, which contains a primary explosive. The small yet violent detonation of the primary explosive initiates the deflagration of the gunpowder. Despite many fears and paranoia, most

primary explosives can be safely worked with without any fear. On a lighter note: it should be noted that most accidents involving primary explosives are the result of peoples stupidity, ignorance, incompetence, or just plain bad luck!

“Secondary explosives” make-up the bulk of high explosives, and are the most powerful. Secondary explosives include: HMX, RDX, TNT, nitrophenols, HNS, tetryl, PETN, nitroglycerine, other polynitro alcohols, TATB, PETN, other polynitro esters, HNIW, MNA, and nitrocellulose. Secondary explosives get their name from the high degree of stability most of them poses. Secondary explosives normally require significant outside energy to initiate detonation. Most secondary explosives can easily be melted, and then poured into moulds for a variety of applications. This degree of stability makes it possible to manipulate these powerful compounds for use in bombs, missiles, shape charges, ect., ect., which would other wise be impossible under any other circumstances. In one given example, TNT is so stable that it can be melted with a flame from a torch. It should be recognized and noted that all secondary explosives can be worked with without any fears—as they are very resistant to shock, percussion, and the like.

TNT being the highest volume explosive made, is often dealt in very large quantities on the factory floor for the preparation of bombs, and explosive shells. In nearly 100 years of TNT preparation, not a single major accident has ever been reported. With TNT aside, most bomb factories deal with thousands of pounds of secondary explosives in a single shift, with few accidents ever reported. The stability of secondary explosives is demonstrated in the following scenarios: explosives such as TNT, RDX, HNIW, and others can be set on fire, thrown against walls, stepped on, mangled, and seriously abused without fear of detonation.

Even though secondary explosives have a high degree of stability, they are still most often mixed with inert fillers such as plasticizers, dry powders, polymers and/or other ingredients to form what are called “explosive compositions”. Such compositions include: Comp B, C3, C4, and PBX. These compositions have even more stability and are used in military operations, and commercial demolition operations.

A famous secondary explosive of the nitrated alcohol group, commonly called nitroglycerine, is itself allot more stable then most people have been lead to believe. Hollywood movies and TV programs tend to over inflate the sensitivity of nitroglycerine. Other secondary explosives with similar properties have been over come with the same stereotypes.

As previously discussed, many secondary explosives are often mixed with inert ingredients to render even more stability. The addition of these inert fillers, absorbents, and other ingredients is as old as high explosives science itself, and makes-up the foundation of explosive compositions. One of most important types of inert fillers added to secondary explosives, are called plasticizers. Plasticizers are common liquid polymers found in a variety of non-explosive commercial products such as paints, lubricants, and insulating products. A common explosive composition called C4, is a mixture containing about 96% RDX, and about 4% plasticizer. It should be noted that inert fillers like plasticizers are added to secondary explosives to make uniform compositions with specific physical properties—all depending upon certain environmental conditions. One such example is demonstrated by high velocity explosive projectiles—such that as artillery shells, and tank fired projectiles. High velocity explosive compositions require a high degree of stability combined with long-term storage ability. In another such example, land mines also require a high degree of stable explosive for long periods of time, which is provided by explosive compositions.

10e. Initiation of explosives

As previously stated, primary explosives are easily detonated, and secondary explosives are much more stable and require significant energy to bring about detonation. Because primary explosives are relatively easy to initiate, the initiation of explosives primarily deals with secondary explosives. To initiate secondary explosives, a sequence of events called an explosive train is put into practice. An explosive train is merely a “chain” composed of two or more explosives lined-up in a row. The first ingredient in an explosive train utilizes a primary explosive. Because primary explosives readily detonate when subjected to heat, fire, ect., they are easily initiated by the heat from a black powder fuse, or electrical bridge wire. The explosive train is most often carried in a simple device called a blasting cap or detonator. Most blasting caps and detonators are composed of three main components. The first component or ignition charge (commonly referred to as initiating compositions), is a primary explosive selected from a fine category of metal or ammonium nitro phenyl compounds, diazodinitrophenol, or some other relative primary explosive. This ignition charge is initiated by a black powder fuse, or electrical bridge wire. The initiation of the ignition charge detonates a secondary or booster charge. The booster charge is often composed of lead azide because lead azide is capable of transferring the necessary energy to the base charge. The base charge is usually the third and final component of any blasting cap or detonator, and is composed of a secondary nitramine explosive—RDX is the most common nitramine base charge. The RDX base charge provides the crucial energy to provide adequate molecular shock to detonate the explosive bulk from which the blasting cap or detonator has been applied to. The most common ignition charges are lead styphnate, diazodinitrophenol, fulminates, and salts of nitrotriazoles and tetrazoles. The secondary or booster charges usually include: azides, metal or ammonium salts of nitro phenyls, salts of nitrotriazoles, tetrazoles, and azanitro compounds. Base charges include: RDX, HMX, methylnitramine, and other nitramine explosives. Blasting caps are usually elongated tubes ranging from 0.20 inches to 0.50 inches in diameter by 2 to 6 inches long. As mentioned before, detonators are similar to blasting caps in their function, but are usually different in size. Detonators can range in size from a small cylindrical disc, to the size of a softball. Blasting caps and detonators are both used in many similar applications, but blasting caps are normally reserved for demolition operations, and for triggering claymore mines, makeshift

munitions, and other man-fired devices or booby traps thereof. Detonators are commonly found in many types of explosive munitions, such as land mines, torpedoes, missiles, and rockets.

A third type of “detonator”, which is much less common in the civilian world, is known as “fuses”. Fuses in this sense do not refer to fuses used for fireworks and cannons (i.e., cannon fuse). Fuses are specially designed devices, usually mechanical in nature, but they can be electronic in nature as well. They utilize the same explosive trains found in blasting caps and detonators, however, they are utilized in much different ways. For example, artillery shells, mortar bombs, aerial bombs, some types of rockets, and tank shells use fuses to initiate the munition at specific times, and without the aid of setting an initial countdown such as a flip of a switch, or ignition of a black powder fuse by the operator. In a more specific example, a grenade fuse detonates the grenade only after the pin has been removed, and the grenade thrown by the operator. In another example, artillery fuses detonate the artillery shell upon impact using a series of mechanical adjustments, which trigger a detonator housed within. Artillery fuses can be very complex in nature, and most of them are adjustable, meaning operators have the ability to adjust the fuse for soft targets, hard targets, foliage penetration, and even air-bursting.

10f. The power of explosives

As one might expect, the power of explosives is severe, but it is more severe than most people would realize. High explosives such as HMX, RDX, TNT, tetryl, HNS, picric acid, TATB, PETN, and nitroglycerine generate tremendous force upon detonation. This force, or energy is capable of causing great destruction. The destructive force is divided into three main categories: (A) *Direct shattering*; (B) *Indirect shattering*; and (C) *Concentration Force*.

(A) Direct shattering, is used in mining and demolitions operations, either commercial or military. A primary example is as follows: It is achieved by drilling holes into a structure, either rock, concrete or the like, and then filling the holes with explosive. Upon detonation, the pressure waves produced exert tremendous force upon the surrounding media, causing a direct shattering effect. The exposed media is shattered into different pieces. This is the foundation of mining, and certain demolitions operations. A military example of (A) is as follows: A cruise missile with a special penetrating warhead penetrates several layers of walls, to end up detonating in the center of the building. Once again, the detonation produces severe force upon the inward walls of the building, causing a great shattering effect; the result is massive damage to the interior of the building. Another example would include an anti-ship missile, which utilizes not only (A), but (C) as well. An anti-ship missile is capable of penetrating the hull of a ship using a shape charge, where by a secondary high explosive charge detonates within the ship. The penetration of the hull, and corresponding secondary blast is devastating and is capable of splitting the ship in half, or causing enough damage to sink the ship.

(B) Indirect shattering, is the primary use of explosives, and is encountered very frequently in wartime. The most common of these explosives include: artillery shells, mortars, bombs, missiles, land mines, and grenades. Such munitions are used in large quantities to bomb large areas, and for suppressing enemy movements. These munitions produce the same energy as the examples in (A), but because they are usually detonated on the surface of objects, walls, and surfaces, the surrounding environment is not shattered in the effect found in direct shattering. In the examples of (A), the great shattering effect is primarily attributed to tremendous pressures created by the detonation of the explosives in close containment. In essence, the detonations of indirect shattering are not “contained” as such, and therefore the energy released has the ability to expand and spread out much more efficiently than those of direct shattering. In a simple example, when we detonate 1 pound of TNT on the surface of a concrete wall (1 foot thick) the result is little damage to the concrete wall (overall some mild concaving, mild & shallow fracturing, carbon deposition, mild chipping, and with no penetration of the wall). However, if we were to drill a hole into this same wall, and place the same 1 pound of TNT, the detonation would definitely shatter the wall producing a visible hole. It should be noted that this example only includes 1 pound of TNT. If we were to use more TNT for indirect shattering, the damage to the wall would be much greater—depending on the mass and type of explosive used. Artillery shells, mortar bombs, aerial bombs, and the like use much larger quantities of explosive ranging from 15 pounds to a massive 2000 pounds—as a result, the indirect shattering effect is largely dependant on the amount of explosive used. 2000 pounds of high explosive under indirect shattering is capable of leveling most buildings—with the exception of very large buildings, i.e., the Sears Tower, Madison Square Garden, the former World Trade center, ect., ect., these examples would require quantities ranging from 3000 to 5000 pounds of explosive under direct shattering for demolition.

(C) Concentration force, is the most powerful form of explosives, and is primarily used solely for penetration purposes. This type of force uses what are called shape charges, other wise know as hollow charges. Shape charges are divided into two categories: (1) hollow charges, and (2) linear charges. **(1) Hollow charges** are the most common concentration force devices, and are used extensively in anti-tank, anti-ship, and many types of munitions. Hollow charges (anti-tank munitions) are very common, and their concept and use dates back to the early 1900’s in France—from where they were invented. Hollow charges are called as such, because of the degree of shaping employed to the explosive body. In essence, a hollow charge is composed of a moderately thick walled metallic cone, usually of copper, placed on the inward walls of the explosive body—the explosive body is shaped to adhere to this metallic cone. When the explosive is detonated, using a simple detonator or booster, the energy or matrix formed propagates forwards, and instead of a pressure wave developing, the energy of the matrix is concentrated into a super fine jet. This concentration of energy is formed by the inverted motion of the metallic cone as the matrix applies force to it. As this metallic cone gets inverted by the matrix’s energy, a super fine jet of energy is produced. This super fine jet of energy is composed of super heated gas and solid particles with a forward motion. The forward motion of this super fine jet is

capable of reaching speeds in excess of 30,000 miles per hour (48,280 kilometers per hour). The forward motion of this fine jet (other wise known as a “high energy jet”), is composed of roughly 80% of the total energy release of the explosive body, and is capable of penetrating in known substance (with the exception of reactive armor). The penetration ability is dependent on the exact shape of the explosive charge and its mass. In an example, 1 kilogram of Composition B in the form of a proper hollow charge can penetrate a 15 to 20 millimeter diameter hole through 305 millimeters (12 inches) of solid reinforced homogenous steel. Overall, RDX, TNT, DINA, HNIW, and Methylnitramine are the most common high explosives used in shape charges; however most secondary explosives can be used with satisfactory results.

(2) Linear shape charges are shaped and work in the same manner as hollow charges, but their horizontal length ranges from 1 inch up to 25 feet or more in length. Linear shape charges are extremely valuable for demolition work, and they save millions of dollars in demolition costs, and hundreds of hours in manpower. In a specific example, a linear shape charge 16 inches long composed of 1 pound of high explosive can cut through a steel beam 1 ½ inch thick, 4 inches by 4 inches. Note: Reactive armor is composed of a 2 or 3-inch thick sheet of plastic explosive, which is sandwiched between two steel plates—the steel plates are usually several inches thick. How the reactive armor works is simple; for example, when an anti-tank hollow charge impacts the outer steel plate of the reactive armor, the high-energy jet produced upon detonation, penetrates the outer steel plate, and makes contact with the center layer of plastic explosive. The high-energy jet is capable of detonating this center layer of plastic explosive, which it does. The detonation of the plastic explosive, and the resulting pressure wave, absorbs the incoming high-energy jet—this is the basis behind reactive armor, and the protection of armored vehicles against anti-tank munitions.

10g. The Physical effects of explosives

Obviously, explosives are capable of causing great destruction, and bodily harm; however, excluding demolitions, wars, and military operations, most civilians are seldom injured by high explosives. In the civilian world during peacetime, people who are injured by explosives are usually done so as the result of fireworks, gunpowder devices, or cheap homemade munitions—utilizing simple pyrotechnic compositions. In many cases, black powder is the “explosive” usually encountered in accidents or other explosives oriented situations involving curious teenagers, or other people who are “playing around”. Some of these injuries have been quite serious and have included burns, lost limbs, puncture wounds, and other mutilations to the body. Even though black powder, fireworks, gun powders, and other deflagrating compositions are capable of causing great injuries, they are nothing compared to what high explosives can do to the human body—especially on a weight by weight ration. High explosives are capable of severely mutilating the human body. In a few training examples, we will look at several scenarios that are most unlikely to be encountered in the field, but from which are used to help you better understand the power of explosives. 1) If for example, you were to place 4 ounces of TNT onto the palm of your hand (solid piece, granules, or powder), and detonate it, the blast would blow apart your hand into about 8 or 10 pieces, remove a jagged chunk of your lower forearm, produce charring burns on the upper arm and face, temporarily blind you, and damage your ear drums—from the noise generated. 2) If for example, you were to place 1 pound of TNT onto your chest (solid piece, granules, or powder), and detonate it, the detonation would blow your body into about 10 jagged pieces. Let it be noted that unlike Hollywood movies, explosives injuries are seldom clean cut in nature—meaning that arms and legs don’t get blown off with even straight cuts (like cutting a hot dog or piece of meat with a sharp knife). Explosives tend to rip the body into pieces like a shark or alligator—with jagged uneven bits of bone, flesh, and body parts removed or left dangling. In some cases explosives have completely scorn the flesh off people’s faces, arms, legs, and chest to the point where bone and organs are clearly visible.

As far as the obvious effects of explosives injuries upon the body are recognized, other effects, known as the secondary effects of exposure to detonations include: temporary loss of vision (looking at the detonations up close at night, or in poorly lighted areas), hearing impairment (explosives produce tremendous noise upon detonation—the noise tends to be a very deep based rumble with multiple sound frequencies produced), fragmentation wounds (caused by flying debris), burns (caused by super heated gases), and inhalation and/or skin absorption of poisonous fumes (produced upon detonation of many high explosives)—although this last secondary effect is quite uncommon, and rarely a factor).

Fragmentation wounds are the second most common effect of exposure to high explosive detonations—although in some cases they are the most common effect—many munitions designed for war, are designed specifically to release large amounts of fragments upon detonation. These munitions are commonly called anti-personnel munitions and can range in size from simple land mines, to large aerial bombs.

Fragmentation wounds cause a whole multitude of problems as they are like multiple gun shot wounds. Treating and fixing these wounds can be pain staking and difficult with many problems to face and overcome during the procedures. Patients have died many hours later due to many types of complications as a result of fragmentation wounds. On the battlefield, treatment of fragmentation wounds can be very difficult, as they tend to persistently bleed. It should be noted (although not generally practiced by military personnel), that the bleeding can be controlled by the following technique: immediately soak a towel or cloth with a concentrated solution of ferric chloride hydrate, and then place this garment directly onto the fragmentation wound—apply pressure, and then bandage thoroughly. Note: The ferric chloride hydrate acts as a strong coagulant, causing the blood to clot.

Chapter 2: Laboratory techniques, and procedures

Now that you have received training in general chemistry, and laboratory techniques, you are now ready to familiarize yourself with basic intermediates, reagents, and solvents used in the preparation of high explosives. Shortly thereafter, you will be immersed into the world of explosives making, and you will learn first hand how these violent compounds are made, their uses, and general munitions. Always remember to practice all safety hazards given, and perform all procedures with great care and caution. Always remember that explosives don't blow themselves up, people do! Be advised, and stay aware of what you are doing, and how you are doing it. By simply following the rules, maintaining proper safety, and warnings, you will be able to successfully carryout these procedures if you so desire without any problems. Let it be know that you take full responsibility for your actions, and any problems, injuries, deaths, property damage, ect., ect., as a result of this book or any of the information contained herein (in anyway) is yours, and yours only. Period.



CHEMICAL REAGENTS, INTERMEDIATES, AND SOLVENTS

CHAPTER 3: REAGENTS, INTERMEDIATES AND SOLVENTS USED IN THE PREPERATION OF HIGH EXPLOSIVES

In this section, you will learn about crucial intermediates, reagents, and solvents used in the preparation of high explosives. Let it be know however, that many of the reagents and solvents used in this book are not included in the following section because they are consider quite common, and any information on them is readily available from many sources, including dictionaries, The Merck Index, and many other sources.

Acetonitrile



Acetonitrile

Acetonitrile is a colorless liquid with an ether-like odor. Acetonitrile is a toxic liquid, and can be absorbed through the skin. It is flammable burning with a luminous flame. It has a melting point of -45 Celsius, and a boiling point of 82 Celsius. It is miscible with water, methanol, methyl acetate, ether, chloroform, carbon tetrachloride, and many unsaturated hydrocarbons. Acetonitrile is an excellent solvent that dissolves many inorganic salts. It forms a constant boiling mixture with water (84% acetonitrile with a boiling point of 76 Celsius). Acetonitrile occurs in coal tar, and is a widely available commercial chemical. *Wear gloves and use proper ventilation when handling acetonitrile. Acetonitrile is toxic by inhalation or skin absorption.*

Acetyl chloride

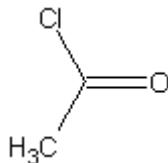

Acetyl chloride

Acetyl chloride is a colorless, flammable liquid with a pungent irritating odor. It has a melting point of -112 Celsius, and a boiling point of 52 Celsius. The liquid is highly irritating to the eyes. It decomposes violently with water or alcohol. Acetyl chloride is miscible with benzene, chloroform, ether, glacial acetic acid, and petroleum ether. It can be prepared by treating sodium acetate with sulfuryl chloride, or by the action of phosphorus trichloride upon glacial acetic acid, and distilling the resulting mixtures.

Acrolein

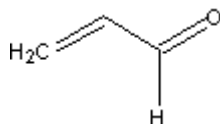

Acrolein

Acrolein is a flammable liquid with a pungent odor. It has a melting point of -88 Celsius, and a boiling point of 53 Celsius. Acrolein is moderately soluble in water, and soluble in alcohol and ether. It is unstable and tends to polymerize especially in the presence of light, alkali, or strong acids; keep stored in amber glass bottles in a refrigerator. It can be made in the lab by distilling a mixture of water free glycerol, potassium bisulfate, and potassium sulfate in the presence of a small amount of hydroquinone, and distilling in the dark.

5-Aminotetrazole

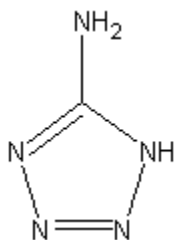

5-Aminotetrazole

Materials:	1. 130 grams of hydrazine-monohydrate
	2. 506 grams of 35 – 38% hydrochloric acid
	3. 218.4 grams of 50% calcium cyanamide solution
	4. 644 grams of 26% sodium nitrite
	6. 97 grams 99% sodium hydroxide

Summary: 5-Aminotetrazole is prepared by reacting hydrazine monohydrate with hydrochloric acid, and calcium cyanamide solution. Afterwards, hydrochloric acid and sodium hydroxide are added, and then the mixture is heated. Afterwards, the mixture is cooled, and upon cooling, the 5-aminotetrazole precipitates. It is then collected by vacuum filtration. Commercial & Industrial note: For related, or similar information, see Application No. 392,308, February 22, 1995, by Nippon Carbide Kogyo Kabushiki Kaisha, Tokyo, JP, to Masahiro Murotani, Toyama, JP, Hajime Mura, Uozu, JP, Makoto Takeda, Takaoka, JP, and Hiroshi Shibafuchi, Uozu, JP. Part or parts of this laboratory process may be protected by international, and/or commercial/industrial processes. Before using this process to legally manufacture the mentioned compound, with intent to sell, consult any protected commercial or industrial processes related to, similar to, or additional to, the process discussed in this procedure. This process may be used to legally prepare the mentioned compound for laboratory, educational, or research purposes.

Hazards: Use caution when handling concentrated hydrazine solutions; never boil them alone, and keep them away from strong oxidizers. Use proper ventilation when handling concentrated hydrochloric acid; fumes and liquid are very irritating and corrosive.

Procedure:

Step 1: Preparing the 5-aminotetrazole

To a 2000-milliliter 3-neck flask equipped with a thermometer, stirrer, and condenser, place 130 grams of hydrazine-monohydrate. Then while stirring the hydrazine monohydrate, add 263.6 grams of 35% hydrochloric acid, then 218.4 g of 50% calcium cyanamide solution, and then 370 grams of water. After the addition of the water, heat the mixture to 85 Celsius for 6 ours. After heating for 6 hours, add 243.2 grams of 35% hydrochloric acid while stirring the reaction mixture, and then after the addition of the 35% hydrochloric acid, reduce the heat to lower the temperature of the reaction mixture to 40 Celsius. When the temperature reaches 40 Celsius, add 643.4 grams of a 26% sodium nitrite solution drop-wise, over a period of 30 minutes while continuously stirring the reaction mixture. Afterwards, remove the heat source, and allow the reaction mixture to cool to room temperature. After which, allow the reaction mixture to stand over-night at room temperature with stirring. After allowing the reaction mixture to stand at room temperature over night, add 97 grams of sodium hydroxide while stirring the reaction mixture. After the addition of the sodium hydroxide, heat the reaction mixture to 85 Celsius for 6 hours. After 6 hours,

remove the heat source and allow the reaction mixture to cool to room temperature. Then place the reaction mixture into an ice bath and cool to 0 Celsius. Afterwards, filter-off the precipitated product, and then vacuum dry or air dry. The result will be 248 grams of 5-aminotetrazole in the crystalline form.

Step 2: Preparation of 5-aminotetrazole monohydrate

Place 248 grams of the product obtained in step 1 into an appropriate flask and then add 740 grams of water, and then heat the mixture for 2 hours at 85 Celsius. After heating for 2 hours, remove the heat source and allow the mixture to cool to room temperature. After which, place the mixture into an ice bath, and cool to 0 Celsius for 2 hours. After 2 hours, filter-off the precipitated product, and then vacuum dry or air-dry.

Step 3: Converting the hydrate to the anhydrous form

Place the hydrated product (obtained in step 2) into an oven, and heat at 110 Celsius for 24 hours to remove the water of crystallization.

Ammonia, anhydrous



Ammonia

Anhydrous ammonia is a colorless gas with a very pungent odor. It has a melting point of -77 Celsius, and a boiling point of -33 Celsius. Ammonia is regarded as nonflammable, but mixtures with oxygen can ignite. Anhydrous ammonia is a corrosive alkaline gas that is very soluble in water. It is also soluble in alcohol, chloroform, and ether. liquid ammonia is a good solvent for many elements and compounds. Commercial anhydrous ammonia is supplied in the form of a compressed gas in steel tanks, or in the liquid form supplied in steel tanks. Ammonia is also widely sold in water solutions. Anhydrous ammonia is the 4th largest chemical produced in the US. Anhydrous ammonia is a widely available commercial chemical. Anhydrous ammonia is prepared on an industrial scale from hydrogen and nitrogen at high pressure and temperature. The average ammonia plant produces 1000 tons of liquid ammonia per day.

Method of preparing anhydrous ammonia

Summary: Anhydrous ammonia can be prepared by treating an ammonium salt solution with a solution of sodium hydroxide. In the following procedure, ammonium chloride or ammonium sulfate is treated with sodium hydroxide to yield ammonia gas, which is then dried to yield the anhydrous gas. The ammonium chloride or sulfate can be prepared by neutralizing 10% ammonia (store bought ammonia) with hydrochloric or sulfuric acids, followed by recrystallization.

Hazards: Wear gloves when handling 50% sodium hydroxide. The alkaline solution may cause painful skin burns on prolonged exposure, and itching sensation on short exposure. Use proper ventilation when making ammonia gas, and avoid inhalation of the vapors.

Procedure: Place 156 grams of 10% ammonia into a flask and then rapidly add 100 grams of 35% hydrochloric acid, or 47 grams of 98% sulfuric acid while stirring the 10% ammonia solution. After the addition of the acid, continue stirring for ten minutes, and then recrystallize the ammonium salt from solution. Afterwards, place the dry recrystallized ammonium salt into an apparatus as illustrated below, and then prepare a sodium hydroxide solution by dissolving 38 grams of sodium hydroxide into 38 milliliters of water (much heat is produced when dissolving sodium hydroxide into water). After the sodium hydroxide solution has cooled to room temperature, add it the ammonium salt drop-wise over a period of about forty minutes. During the addition of the sodium hydroxide, ammonia gas will be steadily evolved.

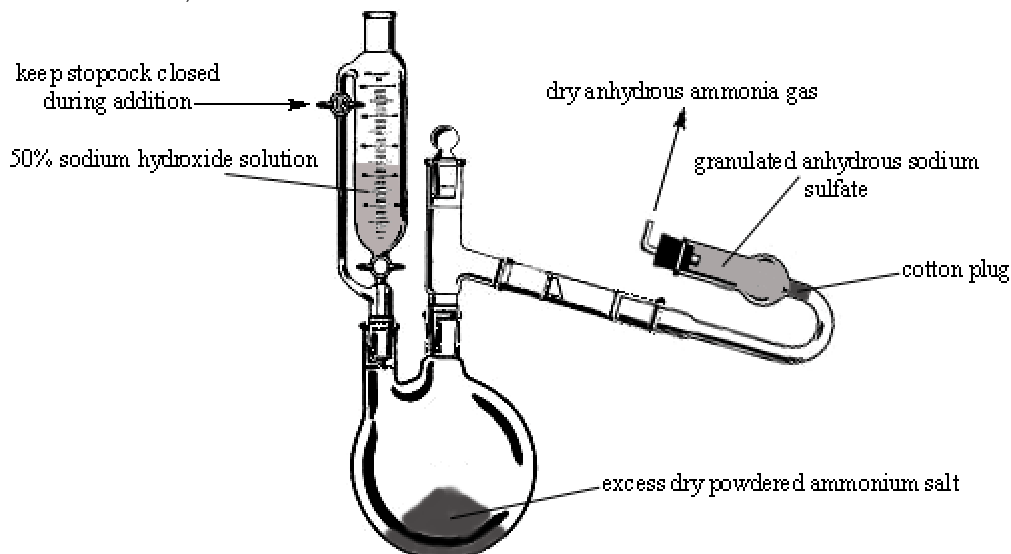

Figure 018. Apparatus for the preparation of anhydrous ammonia.

28 - 30% ammonia solution

28- 30% Ammonia can be Prepared by dissolving 20 grams of ammonia gas into 48 milliliters of water. 28 – 30% ammonia is a highly irritating liquid, which evolves highly irritating vapors. Use proper ventilation when handling this substance. 28 – 30% ammonia solution is commercially available.

13% ammonia solution

Prepare by Diluting 100 grams of 28 - 30% ammonia solution with 130 milliliters of water.

1% Ammonia solution

Prepare by dissolving 1 gram of anhydrous ammonia into 99 milliliters of water, or dissolve 100 grams of 28 – 30% ammonia solution into 2630 milliliters of water.

Ammonium bisulfide. *Ammonium hydrogen sulfide*



Ammonium bisulfide

Ammonium bisulfide forms white, tetragonal or orthorhombic crystals, which sublime in vacuum. Ammonium bisulfide begins to decompose at room temperature into ammonia, and hydrogen sulfide. It is freely soluble in water and alcohol, giving colorless solutions, which may turn yellow on standing. Ammonium bisulfide decomposes in boiling water. It is slightly soluble in acetone, but insoluble in ether, and benzene. It is irritating to the skin and causes hair removal. The commercial product is stabilized to prevent un-wanted decomposition. Ammonium bisulfide should be used shortly after preparation. Keep ammonium bisulfide in tightly sealed containers, and store in a cool place. Ammonium bisulfide is prepared by mixing ammonia and hydrogen sulfide gases at 0 Celsius. Ammonium bisulfide is commercially available.

9% ammonium bisulfide solution

Prepare by dissolving 9 grams of ammonium bisulfide into 91 grams of water.

Ammonium carbamate

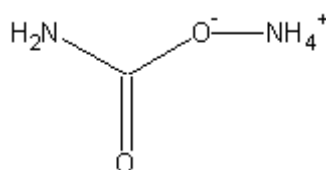

Ammonium carbamate

Ammonium carbamate forms a crystalline powder that has an ammonia odor. The crystals slowly break down on standing, and can be volatilized at 60 Celsius. The crystals are freely soluble in water, and relatively soluble in alcohol. It is prepared by treating liquid ammonia with dry ice, and then allowing the remaining liquid ammonia to evaporate.

Biguanide. *Imidodidicarbonimidic diamide; guanylguanidine*

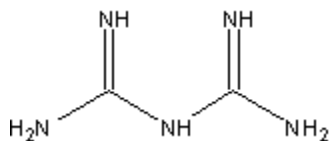

Biguanide

Biguanide forms colorless crystals with a melting point of 130 Celsius. It decomposes rapidly when heated to 142 Celsius. It is insoluble in ether, benzene, and chloroform, but soluble in water and alcohol. Water solutions decompose on standing or heating. Biguanide is considered to be a strong base.

Bromine



Bromine

Bromine is a dark red, highly fuming liquid, which is very volatile. Its fumes are toxic, corrosive, and strongly irritating. Bromine has a melting point of -7 Celsius, and a boiling point of 59 Celsius. It is insoluble in water, but freely soluble in alcohol, ether, chloroform, and carbon disulfide. It is soluble in alkali bromide solutions. Bromine is less reactive than chlorine, but just as toxic. Keep bromine stored in glass stoppered bottles, and store in a cool place (refrigerator) away from sunlight. Bromine is prepared by passing chlorine gas into a solution of sodium bromide, and then simultaneously evaporating the bromine. The bromine vapors are then condensed. Bromine is commercially available but shipping regulations may restrict its sale.

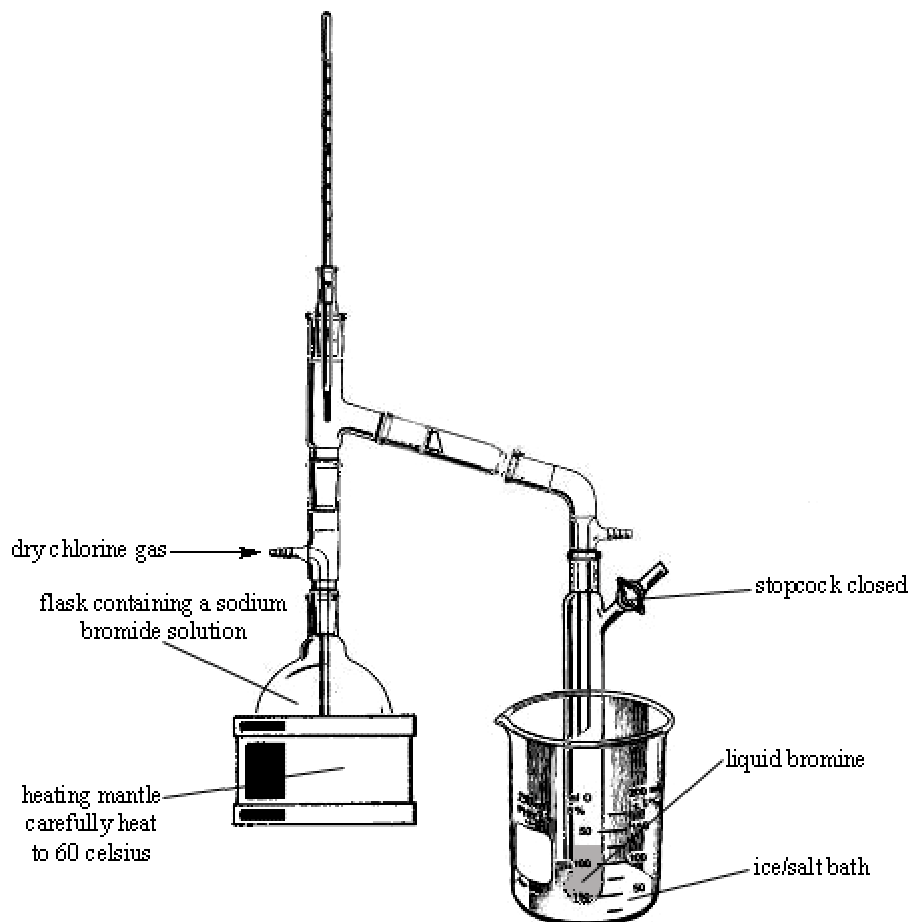
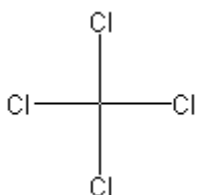

Figure 019. Apparatus for preparing bromine. The bromine should be re-distilled at 60 Celsius.

Carbon tetrachloride



Carbon tetrachloride

Carbon tetrachloride is colorless, heavy, non-flammable liquid with a characteristic odor. It has a boiling point of 78 Celsius, and a melting point of -23 Celsius. Carbon tetrachloride is insoluble in water, but miscible with alcohol, benzene, chloroform, ether, and carbon disulfide. Carbon tetrachloride is a potential poison, and inhalation, ingestion, and skin absorption should be avoided at all cost. Carbon tetrachloride may be a carcinogen. It is prepared on an industrial scale by the chlorination of methane, but can be conveniently prepared by reacting chlorine with carbon disulfide in the presence of iron fillings; the carbon tetrachloride is recovered by distillation.

Chloroform. *Trichlormethane*

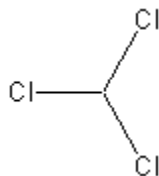

Chloroform

Chloroform is a highly refractive, nonflammable, heavy, very volatile, and sweet-tasting liquid with a peculiar odor. It has a boiling point of 62 Celsius, and a melting point of -64 Celsius. Chloroform forms a constant boiling mixture with alcohol containing 7% alcohol, and boiling at 59 Celsius. Commercial chloroform contains a very small amount of ethanol as stabilizer. It is insoluble in water, but miscible with alcohol, benzene, ether, petroleum ether, and carbon disulfide. Pure chloroform is light sensitive, so store in amber glass bottles in cool place. Chloroform is a suspected light carcinogen, so use proper ventilation when handling. Over exposure to chloroform vapors causes dizziness, and headache. **Note:** Distilling mixtures containing chloroform mixed with one or more strong base (lithium, sodium, or potassium hydroxide) can result in explosion. Always neutralize any base, or extract the chloroform before distilling the chloroform.

Method of preparing chloroform

Summary: Chloroform is prepared by reacting acetone with calcium hypochlorite, and then extracting the mixture with toluene. After extraction, the toluene/chloroform mixture is then double distilled to collect the chloroform in the receiver flask. After collecting the chloroform, it is mixed with a small amount of 95% ethanol to act as a stabilizing agent.

Hazards: Extinguish al flames before suing acetone, which is highly volatile and flammable. Calcium hypochlorite is a powerful oxididizer, and should never be mixed with concreted sulfuric acid; explosions will result. Chloroform inhalation should be avoided, but is not threatening in mild condition.

Procedure: Place 100 grams of water and 100 grams of acetone into a beaker, and then cool to 0 Celsius while stirring. Then slowly add in small portions, 1181 grams of 65 to 70% calcium hypochlorite (commercially available; sold under a variety of brand names for use in swimming pools and hot tubs) over a period of 1 hour while stirring the acetone solution and maintaining its temperature at 0 Celsius. After the addition of the 65 to 70% calcium hypochlorite, continue to stir the reaction mixture at 0 Celsius for an additional thirty minutes. Afterwards, stop stirring and then extract the reaction mixture with four 100-milliliter portions of toluene. After extraction, combine all four portions (if not already done so), and then place the combined portions into a distillation apparatus and then distill at 65 Celsius until no more chloroform passes into the receiver flask. When no more chloroform passes into the receiver flask, stop the distillation, and then remove the receiver flask from the distillation apparatus. Then add 20 grams of anhydrous calcium chloride to the receiver flask, and then swirl the flask for ten minutes. After which, filter-off the calcium chloride and then pour the filtered chloroform into a clean distillation apparatus and distill at 62 Celsius until no more chloroform passes into the receiver flask. When no more chloroform passes into the receiver flask, stop the distillation, and then remove the chloroform from the receiver flask and then add 1 milliliter of 95% ethanol to the chloroform. Then store the chloroform in an amber glass bottle.

Chlorine gas



Chlorine gas

Chlorine gas is a yellow gas with a suffocating, and strongly irritating odor. It has a melting point of -101 Celsius, and a boiling point of -34 Celsius. Chlorine is sold as a compressed gas in steel cylinders. It is insoluble in water and not very soluble in alcohol, but soluble in dry benzene, and toluene. Chlorine combines readily with all elements except the noble gases, hydrogen, oxygen, and nitrogen. Chlorine does not occur naturally, but occurs in combined form as chlorides. It occurs in nature (in the form of chlorides) as sodium chloride, potassium chloride, and magnesium chloride. Many finely divide metals will burn in a chlorine atmosphere. Chlorine is a toxic gas, which can be fatal if inhaled for prolonged periods of time. Inhalation of mild quantities of chlorine causes nose and throat irritation followed by excessive mucous congestion in the nose. Chlorine is a corrosive gas, which will react with many metals on contact. It is a strong oxidizer and is capable of oxidizing a great many inorganic compounds. Chlorine will explodes in contact with hydrogen if direct sunlight is present. Chlorine should be protected from sunlight. It is the 10th largest chemical manufactured in the US. It was used as a chemical warfare agent in WWI, but due to its lack of toxicity, and poor environmental capacity (dissipates rapidly), its use has ended. Chlorine is prepared on an industrial scale from the electrolyses of sodium chloride brine in a system called the chloro-alkali process (sodium hydroxide is a useful by-product). It can be prepared in the lab by reacting hydrochloric acid with calcium hypochlorite or liquid bleach (Clorox), by the electrolysis of hydrochloric acid, or by using a diaphragm cell. Note: In the electrolysis of hydrochloric acid, hydrogen gas is also produced. Despite the presence of this hydrogen, the chlorine can be directly used in chemical reactions because the hydrogen acts more like an inert gas. The chlorine does not react with this hydrogen, even if the gas mixture is moderately hot.

Warning: If the apparatus is exposed to direct sunlight, detonation will occur. Chlorine explodes when mixed with hydrogen and exposed to sunlight. The detonation propagates downwards, so there is no immediate danger from fragments. As a reminder, the electrolysis of hydrochloric acid is perfectly safe as long as the apparatus is protected from direct sunlight, magnesium light, halogen lamps, or UV lamps (cover all windows, ect.).

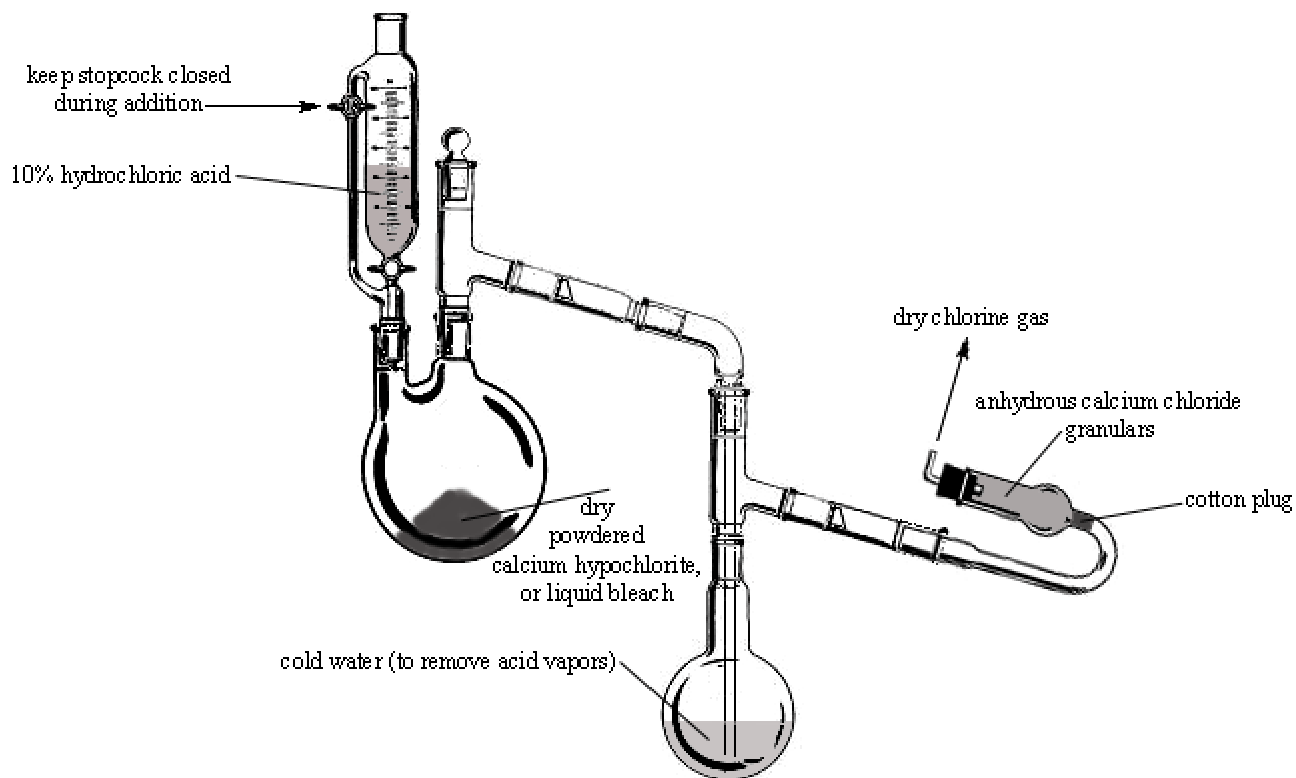

Figure 022. Apparatus for preparing chlorine gas (manganese dioxide can be used instead of calcium hypochlorite).

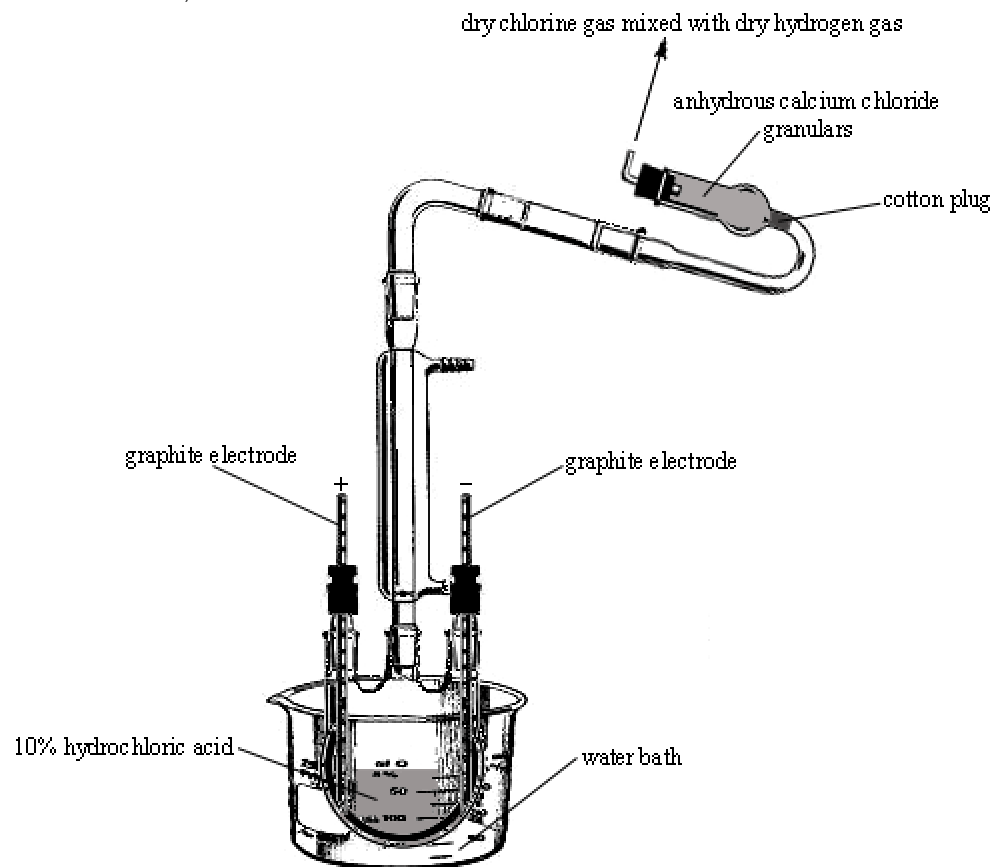

Figure 023. Apparatus for the electrolysis of hydrochloric acid.

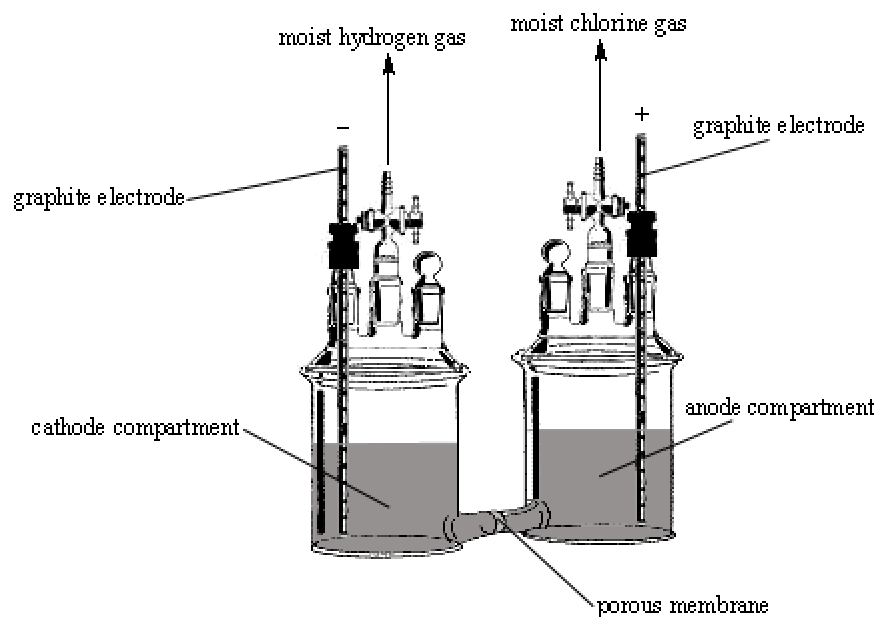
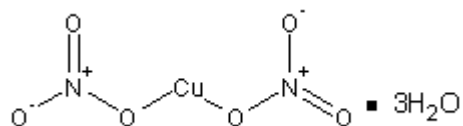

Figure 024. Diaphragm cell for the production of chlorine. The moist chlorine can be easily dried using a calcium chloride drying tube, and afterwards, will be in high purity.

Copper-II-nitrate trihydrate



Copper nitrate

Copper-II-nitrate trihydrate forms bluish, deliquescent, rhombic crystal plates melting at 114 Celsius. It is freely soluble in water and alcohol. It is obtained by dissolving copper into dilute nitric acid, recrystallizing the hexahydrate from solution, followed by gently heating the hexahydrate at 30 Celsius for several hours.

Cyanoacetic acid. *Malonic mononitrile*

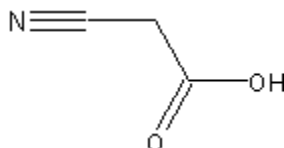

Cyanoacetic acid

Cyanoacetic forms hygroscopic crystals with a melting point of 66 Celsius. It decomposes when heated to 160 Celsius into carbon dioxide and acetonitrile. Cyanoacetic acid can be distilled at reduced pressure; boiling point 108 Celsius. It is soluble in water, alcohol, and ether, but only slightly soluble in benzene or chloroform. It can easily be made by reacting chloroacetic acid with sodium cyanide.

Cyanogen bromide



Cyanogen bromide

Cyanogen bromide forms needles, or cubes with a melting point of 52 Celsius, and a boiling point of 62 Celsius. The crystals are very volatile at room temperate, and the vapors are highly poisonous. The crystals are freely soluble in water, alcohol, and ether. It is prepared by reacting sodium or potassium cyanide with bromine. The crystals readily decompose on standing, but can be stored for months in a desiccator over metallic sodium. The crystals may explode if contaminated with impurities. Use caution when handing this substance. Avoid skin contact and inhalation. Symptoms of exposure are similar to that of hydrogen cyanide. See The Preparatory Manual of Chemical Warfare Agents.

DAPT. *3,7-Diacetyly-1,3,5,7-tetraaza[3.3.1]bicyclononane*

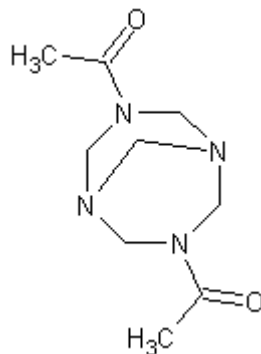

DAPT

Materials:	1. 1960 grams of hexamine
	2. 1060 grams acetic anhydride

Summary: DAPT is prepared by reacting hexamine with acetic anhydride in the presence of water. First, hexamine is added to cold water forming a slurry. This slurry is then cooled and treated with acetic anhydride. The DAPT is then recovered from the reaction mixture by filtration. Commercial & Industrial note: For related, or similar information, see Application No. 476,947, January 3, 1999, by Schlumberger Technology Corporation, to William J. Lukasavage, Pearland, TX, Lawrence A. Behrmann, Houston, TX, and Wallace E. Voreck, Sparta, NJ. Part or parts of this process may be protected by international, and/or commercial/industrial processes. Before using this process to legally manufacture the mentioned compound, with intent to sell, consult any protected commercial or industrial processes related to, similar to, or additional to, the process discussed in this procedure. This process may be used to legally prepare the mentioned compound for laboratory, educational, or research purposes.

Hazards: Wear gloves when handling acetic anhydride, which can cause skin burns.

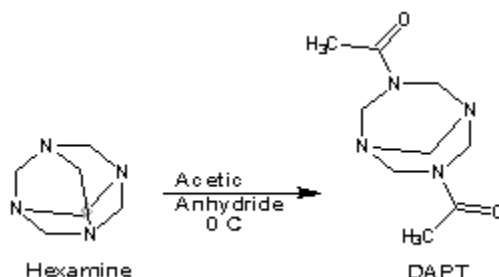

Reaction Equation

Procedure: To a 4-liter container place 1960 grams of hexamine. Then add 1960 milliliters of cold water, and then stir the mixture rapidly for 1 hour. After 1 hour, place the 4-liter container into an ice bath, and cool the 4-liter flask to 0 Celsius. Afterwards, add 980 grams of ice, and then rapidly add 1060 grams of acetic anhydride over a period of about 1 minute while rapidly stirring the reaction mixture, and maintaining its temperature at 0 Celsius at all times. After the addition of the acetic anhydride, continue stirring at 0 Celsius for 10 minutes. After 10 minutes, place the entire reaction mixture into a distillation apparatus and distill at 140 Celsius for 4 hours. After 4 hours, remove the heat source and allow the reaction mixture to cool to room temperature. Then filter-off the precipitated DAPT, wash with 400 milliliters of cold water, and then vacuum dry or air dry.

Diethyl ether. *Ether*

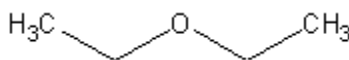

Diethyl ether

Diethyl Ether, other wise known as just ether, is a mobile, very volatile, highly flammable liquid, which produces explosive vapors. It has a sweetish, pungent odor, and a burning taste. Ether forms explosive peroxides when exposed to air (ether containing peroxides will detonate if heated, shattering the glass vessel. Before heating mixtures containing ether, the peroxide test should be conducted. To test for peroxides, add five drops of ferrous chloride solution to the ether mixture. If a red color appears, peroxides are present. *Note: This test will not work properly if there are oxidizing agents in the ether mixture.* Ether can be stabilized by the addition of small amounts of naphthols, but this does not protect ether 100% from peroxide formation. Ether has a melting point of -116 Celsius, and a boiling point of 35 Celsius. Ether and air mixtures are explosive, so extinguish all flames and do not smoke when handling it. Protect ether from static electricity, which can also cause fire. Ether is insoluble in water, but miscible with alcohol, benzene, chloroform, and many oils. Do not mix 99% nitric acid with ether, as detonation will take place. Inhalation of ether vapors can produce intoxicating effects. These effects include feelings of euphoria, well-being, relaxation, and a general state of high. These effects can also lead to feelings of drunkenness, and hallucinations. Ether is a narcotic in high concentrations, but is not habit forming. Store ether in tightly sealed bottles in a cool place (preferably in a refrigerator). For prolonged storage, store ether over sodium sulfite and keep in a bottle filled to the top (to minimize the air space). Ether can be prepared by heating 95% ethanol and 98% sulfuric acid (1 to 1 ratio) to 100 Celsius, and simultaneously condensing the distilled-off vapors of ether. The ether is then purified by re-distillation. Ether is a widely available commercial chemical.

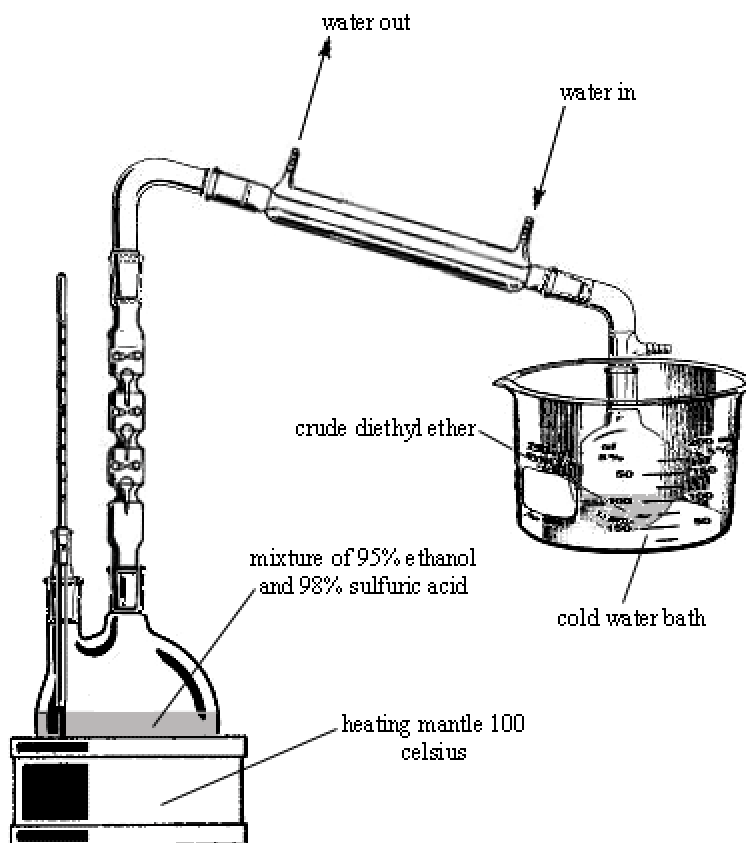
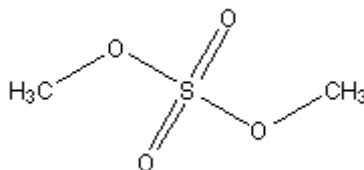

Figure 026. Apparatus for the preparation of diethyl ether. The ether should be re-distilled.

Dimethyl sulfate



Dimethyl sulfate

Dimethyl sulfate is a colorless oily liquid with a boiling point of 188 Celsius (with decomposition), and a melting point of -27 Celsius. It is slightly soluble in water, but soluble in ether, dioxane, acetone, and benzene. It is prepared by distilling methanol with fuming sulfuric acid, or by treating dimethyl ether with sulfur trioxide. Dimethyl sulfate is poisonous, and may be a carcinogen so wear gloves, and use proper ventilation when handling. The liquid can be absorbed through the skin.

Dioxane. 1,4-Diethylene dioxide

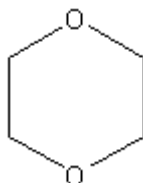

Dioxane

Dioxane is a flammable liquid with a faint pleasant odor. It has a melting point of 12 Celsius, and a boiling point of 101 Celsius. It forms an azeotropic mixture with water containing 81.6% dioxane by weight with a boiling point of 88 Celsius. Dioxane also forms an azeotropic mixture with ethanol containing 9.3% dioxane by weight with a boiling point of 78 Celsius. Dioxane is soluble in water, and the usual organic solvents. It forms explosive peroxides if stored in the presence of air. Dioxane is a toxic carcinogen so avoid ingestion, inhalation, or skin contact. Keep dioxane in tightly sealed bottles filled to the top. Dioxane is prepared by distilling ethylene glycol with dilute sulfuric acid. Dioxane is commercial available, and can be obtained from some solvent mixtures by distillation. Before distilling dioxane, perform the same peroxide test as used with ether.

Materials:	1. 200 grams ethylene glycol
	2. 6.4 grams 98% sulfuric acid
	3. 120 grams anhydrous calcium chloride

Summary: Dioxane is prepared by treating ethylene glycol with sulfuric acid, and then distilling the mixture at 110 Celsius. After the distillation, the dioxane is treated with anhydrous calcium chloride to absorb water, and then the mixture is filtered. After filtration, the liquid is re-distilled. Commercial & Industrial note: Part or parts of this laboratory process may be protected by international, and/or commercial/industrial processes. Before using this process to legally manufacture the mentioned compound, with intent to sell, consult any protected commercial or industrial processes related to, similar to, or additional to, the process discussed in this procedure. This process may be used to legally prepare the mentioned compound for laboratory, educational, or research purposes.

Hazards: 98% Sulfuric is a strong dehydrating agent; it is capable of charring a great many substances including cloths, and some plastics. Handle with care. Handle dioxane with care. Dioxane is a known carcinogen.

Procedure: Place 200 grams of ethylene glycol and 6.4 grams of 98% sulfuric acid into a distillation apparatus, and then distill the mixture at 110 Celsius for 6 hours. During the 6 hours, a distillate containing dioxane, water, and by-products will be obtained in the receiver flask. After the 6 hours, pour the liquid in the receiver flask into a clean beaker, and then add 120 grams of anhydrous calcium chloride. Then thoroughly blend the mixture for 2 hours. After 2 hours, filter-off the calcium chloride, and then place the filtered mixture into a clean distillation apparatus. Then distill at 101 Celsius for 6 hours. After 6 hours, the liquid in the receiver flask will be composed of about 98% dioxane.

95% Ethanol. *Ethyl alcohol; ABS alcohol; grain alcohol*

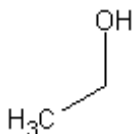

Ethanol

95% Ethanol is a clear, colorless, very mobile, flammable liquid with a pleasant odor, and a pungent, burning taste. It has a boiling point of 78 Celsius and a melting point of -114 Celsius. 95% Ethanol slowly absorbs water from the air, and dilute ethanol solutions are slowly oxidized by air forming brown colored solutions containing mixtures of aldehydes, and carboxylic acids; mainly acetic acid. 95% Ethanol is miscible with water, and many organic solvents. 95% ethyl alcohol is called absolute ethanol because ethyl alcohol forms a binary azeotrope containing 95.57% ethyl alcohol by weight with a boiling point of 78 Celsius. Distillations cannot produce 99% ethanol because of this azeotrope. Ethyl alcohol is usually sold as denatured ethyl alcohol (mixed with small amounts of toxic chemicals to make non-drinkable) due to US government tax regulations. 95% Ethyl alcohol is toxic, and ingestion can cause alcohol poisoning. Dilute mixtures of ethanol (Vodka, Gin, Rum, Jack Daniels, beer, wine) produce intoxicating effects when ingested (these intoxicating effects can be increased if the dilute ethanol mixture is injected). 95% ethanol can be made by fermenting starch or sugars with yeast, followed by double distillation. 95% Ethanol is manufactured on an industrial scale by the petroleum industry from ethylene gas, sulfuric acid, and water. 95% Ethanol is a widely available commercial chemical sold under a variety of names. 95% ethanol can be obtained from double distillation of alcoholic beverages such as vodka, gin, or rum.

Method of preparing 95% ethanol

Summary: 95% ethanol can be prepared by double distilling cheap vodka. After the first distillation the distilled liquid is treated with baking soda to remove odors, filtered, and then the filtered liquid is redistilled producing 95% ethanol.

Procedure: Place 2 liters of cheap vodka (Popov, Kirov, Skol) into a distillation apparatus, and distill at 90 Celsius until no more liquid passes into the receiver flask. When no more liquid passes into the receiver flask, remove the heat source, and then remove the receiver flask from the distillation apparatus. Then place 100 grams of baking soda into the receiver flask, and swirl the flask for ten minutes. Afterwards, filter the liquid to remove the baking soda, and then place the filtered liquid into a clean distillation apparatus. Then distill at 80 Celsius until no more liquid passes into the receiver flask. See figure 016 for details on the appropriate distillation apparatus to be used.

Alternative method of preparing 95% Ethanol

Summary: 95% Ethanol can also be obtained on a lower yield by hydrolyzing table sugar with dilute acid, and then fermenting the resulting mixture with yeast to form an ethanol solution. The solution will be contaminated heavily with by-products so multiple distillations and treatments with baking soda will be needed in order to fulfill proper purification. Baking soda is mixed with the distilled liquid to absorb odors and the like.

Procedure: Dissolve 1 kilogram of table sugar (sucrose) into 3 liters of water. Then rapidly stir this sugar mixture, and heat it to 80 Celsius. When the sugar solution reaches about 80 Celsius, continue stirring and add 5 drops of concentrated hydrochloric acid or 5 drops of concentrated sulfuric acid, and then continue heating and stirring for thirty minutes. After thirty minutes, remove the heat source, and allow the mixture to cool to room temperature. Then add 5 grams of baking soda to neutralize the acid. Afterwards, pour the sugar solution into an empty bottle (such as a clean empty plastic milk jug), and then add 5 to 10 grams of regular yeast (bakers yeast or preferably brewers yeast). Then stir the mixture for several minutes to insure good dispersion of the yeast. Then plug the bottles opening with cotton, and then place the bottle into a cool place away from light. Then allow the sugar mixture to ferment for about 4 weeks. After 4 weeks, remove the cotton from the bottles opening, and then pour the contents of the bottle into a distillation apparatus. Then distill at 100 Celsius for 4 ½ hours. After which, remove the heat source, and then remove the receiving flask from the distillation apparatus. Then add 100 grams of baking soda to the contents in the receiving flask, and then swirl the flask for ten minutes. Afterwards, filter the mixture to remove the baking soda, and then place the filtered liquid into a clean distillation apparatus and distill at 80 Celsius until no more liquid passes into the receiver flask. When no more liquid passes into the receiver flask, remove the heat source, and then remove the receiver flask from the distillation apparatus. Then add 100 grams of baking soda to the receiver flask and then swirl the flask for ten minutes. After ten minutes, filter the mixture to remove the baking soda, and then place the filtered mixture into a clean distillation apparatus and distill at 78 Celsius until more liquid passes into the receiver flask. See figure 027 for details on the appropriate distillation apparatus to be used.

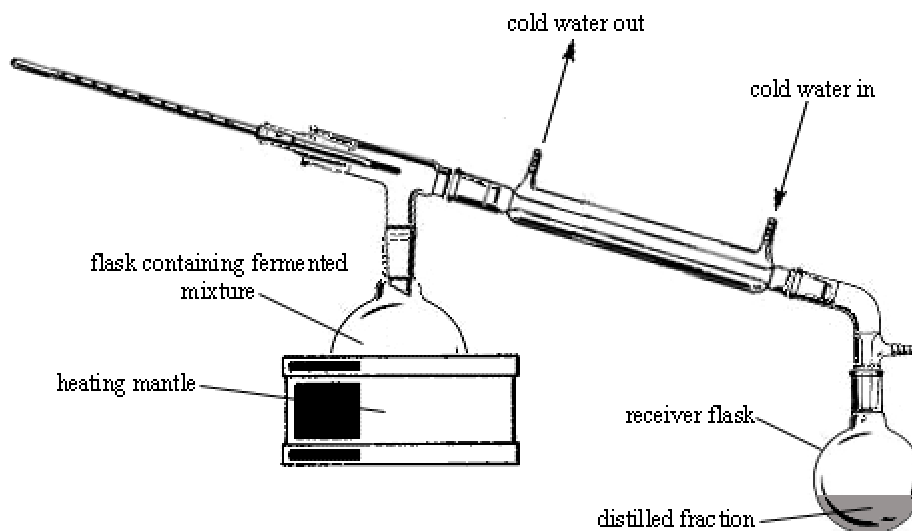
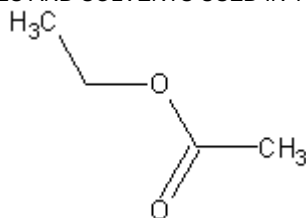

Figure 027. Apparatus for distillation of ethanol

Ethyl acetate



Ethyl acetate

Ethyl acetate is a clear, volatile, and flammable liquid with a pleasant, fruity odor. It has a pleasant taste when diluted. Ethyl acetate slowly decomposes by moisture. It has a boiling point of 77 Celsius, and a melting point of -83 Celsius. Ethyl acetate is moderately soluble in water (1 milliliter in 10 milliliters of water), but is miscible with alcohol, acetone, chloroform, and ether. It forms a azeotropic mixture with water (6% by weight with a boiling point of 70 Celsius). Ethyl acetate can be prepared by distilling a mixture of ethanol and acetic acid in the presence of a few drops of 98% sulfuric acid. Ethyl acetate is a widely available commercial chemical.

Ethyl chloroformate. *Carbonochloridic acid ethyl ester*

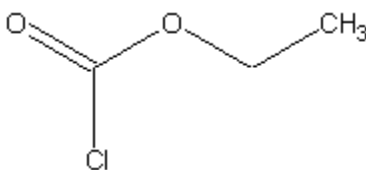

Ethyl chloroformate

Ethyl chloroformate is a corrosive, flammable liquid with a boiling point of 95 Celsius. It is practically insoluble in water, but slowly decomposed by it. Ethyl chloroformate is miscible with alcohol, benzene, chloroform, and ether. It can be prepared by reacting phosgene with ethyl alcohol. Ethyl chloroformate is commercially available.

Ethylenediamine



Ethylenediamine

Ethylenediamine is a colorless, clear, thick liquid with an ammonia odor. It has a boiling point of 117 Celsius, and a melting point of 8 Celsius. Ethylenediamine is volatile with steam, and freely soluble in water, forming a hydrate. It is also freely soluble in alcohol. Keep bottles containing ethylenediamine tightly sealed, because the liquid may absorb carbon dioxide from the air, forming a non-volatile carbonate. Protect ethylenediamine from oxygen and air. Ethylenediamine can be prepared by reacting ethylene dichloride with ammonia. It is commercially available.

88% Formic acid

Prepare by dissolving 100 grams of 99% formic acid into 13 grams of water.

Glycerol. *1,2,3-Propanetriol; Glycerin*

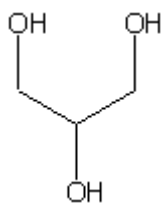

Glycerol

Glycerol is a syrupy liquid with a sweet warm taste. Glycerol is less sweet than cane sugar. It absorbs moisture from the air, and also absorbs gases like hydrogen sulfide, hydrogen cyanide, and sulfur dioxide. Explosions may result if glycerol is treated with strong oxidizers such as chromium trioxide, potassium chlorate, or potassium permanganate. It solidifies at 0 Celsius forming shiny orthorhombic crystals with a melting point of 18 Celsius, and a boiling point of 290 Celsius (with decomposition). Glycerol is miscible with water and alcohol, but is insoluble in benzene, chloroform, and carbon disulfide. Glycerol is much less toxic than grain alcohol, making it the least toxic alcohol known. It can be prepared by boiling 50% sodium or potassium hydroxide solution with cow or pig lard. Glycerol can also be obtained by boiling sodium or potassium hydroxide with the lard obtained from cooking bacon. Glycerol can also be prepared from table sugar by fermentation with yeast in the presence of sodium sulfite. Glycerol is prepared on an industrial scale from propylene gas, and is a cheap widely available commercial chemical.

Glyoxal. *Ethanediol; Biformyl; Diformyl*

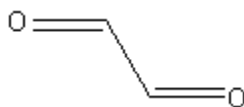

Glyoxal

Glyoxal forms yellow prisms or irregular pieces, which turn white on cooling. Glyoxal has a melting point of 15 Celsius, and a boiling point of 51 Celsius (under pressure). It produces green vapors, which burn with a purple flame. Mixtures of glyoxal vapors with air may explode when ignited. Glyoxal is soluble in most organic solvents, and is usually sold as a 40% water solution. Pure glyoxal polymerizes rapidly and is unstable, but heating the dry polymer changes it back to glyoxal. Glyoxal is never sold as the dry solid because of decomposition problems. The 40% solution is commercially available.

Guanidine

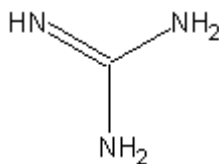

Guanidine

Guanidine is a strong base, which is found in a variety of natural products. These products include turnip juice, mushrooms, corn germ, rice hulls, mussels, and earthworms from which it can be extracted with alcohol. Guanidine forms deliquescent crystals with a melting point of 50 Celsius. It absorbs carbon dioxide from the air, and is very soluble in water and alcohol. It is manufactured on an industrial scale from sulfur dioxide, carbon dioxide, and ammonia gases. Guanidine is a readily available commercial chemical.

Hexamine. *Methenamine; 1,3,5,7-tetraazatricyclo[3.3.1.-1.3,7]decane; hexamethylenetetramine*

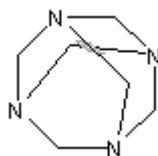

Hexamine

Hexamine forms colorless, odorless, or white granules, powder, or crystals. It sublimates at 263 Celsius without melting, but is volatile below this temperature. Hexamine burns with a smokeless flame, and is used in solid camping fuel pellets (in high purity). 1 gram of hexamine dissolves in 1.5 milliliters water, and 12.5 milliliters of alcohol. It is insoluble in ether. Hexamine is a widely available, and cheap commercial chemical.

Hexanes.

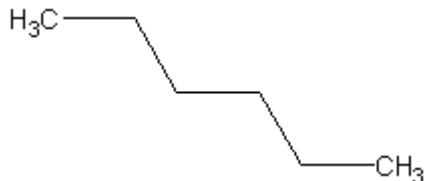

Hexane

Hexanes are a colorless, very volatile liquid with a faint, peculiar odor. It is rarely sold as n-hexane but usually admixed with hexane isomers simply called “hexanes”. Hexane has a boiling point of 69 Celsius, and a melting point of -100 Celsius. It is insoluble in water, but miscible with alcohol, chloroform, and ether. Hexane is a major component of gasoline, and can be distilled from the gasoline using a multiple-path distillation apparatus (see figure 028). Hexane is obtained commercially from petroleum, and is a widely available commercial chemical.

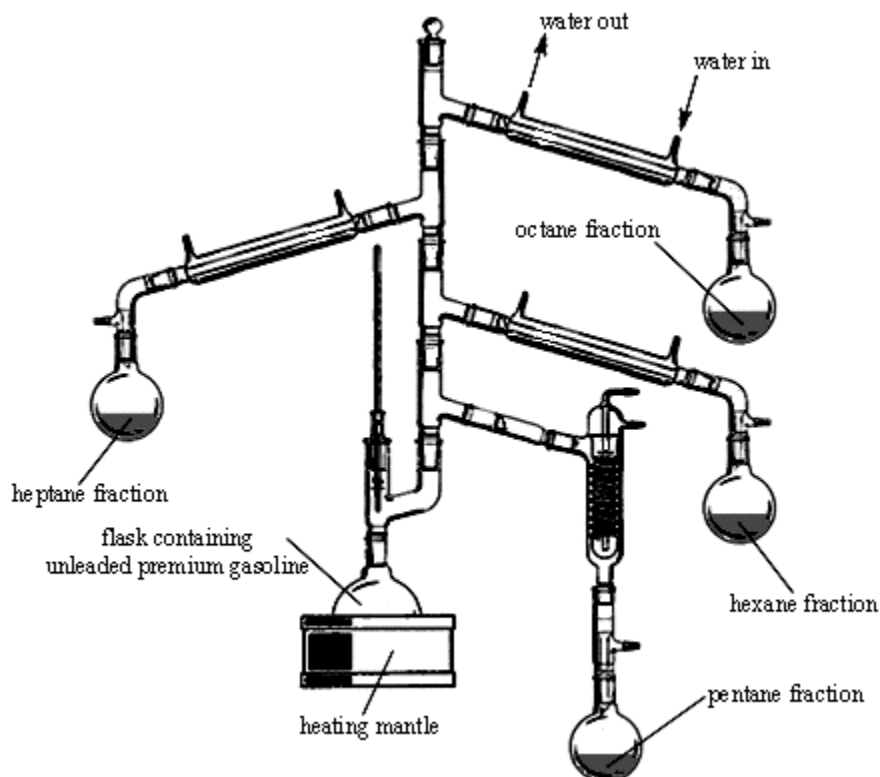

Figure 028. Apparatus for the distillation of unleaded premium gasoline (carefully distill at 70 Celsius).

18% Hydrochloric acid

Prepare by dissolving 100 grams of 35 – 38% hydrochloric acid into 95 milliliters of water.

10% Hydrochloric acid

Prepare by dissolving 100 grams of 35 – 38% hydrochloric acid into 235 milliliters of water.

5% Hydrochloric acid

Prepare by dissolving 100 grams of 35 – 38% hydrochloric acid into 585 grams of water.

Anhydrous hydrogen chloride

Anhydrous hydrogen chloride is a very corrosive, non-flammable gas, with a highly irritating vapor. Hydrogen chloride is very soluble in water, forming a fuming liquid; vide supra, hydrochloric acid. It has a melting point of -114 Celsius, and a boiling point of -85 Celsius. It is prepared by the reaction of concentrated sulfuric acid upon table salt, or by the action of chlorine upon organic compounds. The latter being the chief source of hydrochloric acid.

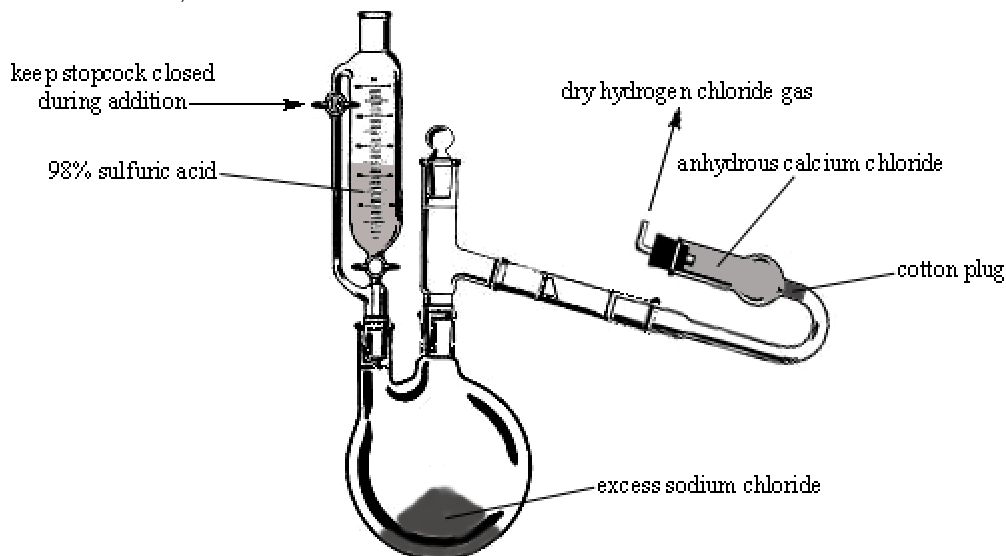
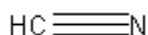

Figure 029. Apparatus for the preparation anhydrous hydrogen chloride

Hydrogen cyanide



Hydrogen cyanide

99% Hydrogen cyanide is a colorless liquid with a characteristic odor. Hydrogen cyanide is a weak acid, which is highly volatile at room temperature. 99% Hydrogen cyanide is a gas at room temperature, and 99% hydrogen cyanide should be stored in tightly sealed bottles in a refrigerator. It has a melting point of -13 Celsius, and a boiling point of 25 Celsius. 99% Hydrogen cyanide burns in the air with a bluish flame. It is highly toxic and exposure to just small amounts can lead to death. 99% Hydrogen cyanide can be prepared by treating potassium cyanide, sodium cyanide, or potassium ferrocyanide with 50% sulfuric acid, and then recovering the vapors by condensation (see figure 030). Liquid 99% hydrogen cyanide should be used shortly after preparation. **Warning!** *Hydrogen cyanide is a deadly poison and exposure to even small amounts of the vapor can lead to death. Use extreme caution when handling this substance, and practice maximum ventilation. Keep a gas mask within reach when preparing or handling this substance. Hydrogen cyanide is used in gas chambers.*

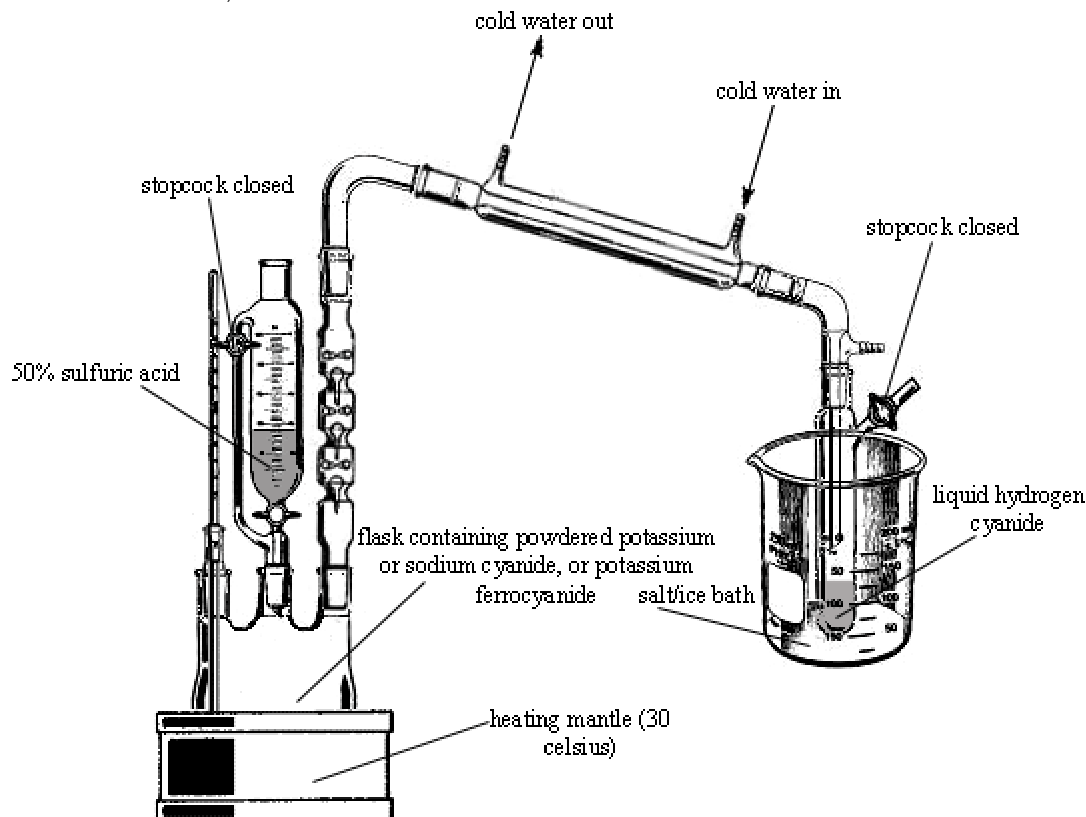

Figure 030. Apparatus for preparation of 99% hydrogen cyanide.

Hydrogen sulfide



Hydrogen sulfide

Hydrogen sulfide is a flammable, poisonous gas with disagreeable odor of rotten eggs. It can be detected by the human nose in extremely small quantities. Hydrogen sulfide has a sweetish taste. Hydrogen sulfide burns in air with a pale blue flame. It has a melting point of -85 Celsius, and a boiling point of -60 Celsius. Hydrogen sulfide is insoluble in water, and not very soluble in alcohol. It is soluble in glycerol, gasoline, kerosene, carbon disulfide, and crude oil. Hydrogen sulfide is a highly toxic gas, and inhalation can be fatal. Use maximum ventilation when handling. It is evolved from many different natural environmental sources including bacterial decomposition of vegetable and animal proteins, natural springs, natural gas deposits, and volcanoes. Hydrogen sulfide can be obtained from the distillation of petroleum. Hydrogen sulfide is prepared in the laboratory by dropping an acid (usually sulfuric or hydrochloric) onto a metal sulfide such as sodium sulfide, or calcium sulfide (calcium sulfide is prepared by roasting calcium sulfate with charcoal at 1000 Celsius). Hydrogen sulfide is commercially available, but shipping regulations may decrease sale.

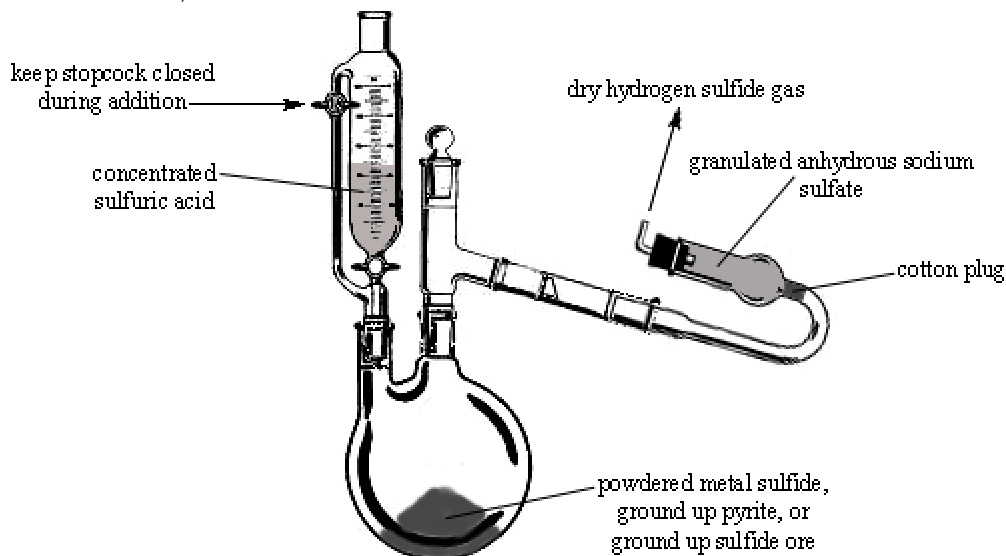
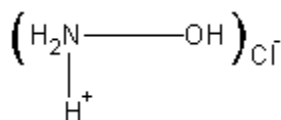

Figure 031. Apparatus for the preparation of hydrogen sulfide gas

Hydroxylamine hydrochloride. *Oxammonium hydrochloride*



Hydroxylamine hydrochloride

Hydroxylamine hydrochloride forms monoclinic columnar crystals, which slowly decompose when exposed to air and water. It has a melting point of 151 Celsius, and is very soluble in water. Hydroxylamine hydrochloride is slightly soluble in methanol, but soluble in glycerol, and propylene glycol. Keep bottles well closed. Hydroxylamine hydrochloride is prepared by treating hydroxylamine with hydrochloric acid (hydroxylamine is prepared by dissolving metallic sodium into liquid ammonia, and then evaporating the excess liquid to obtain dry solid). Hydroxylamine hydrochloride is commercially available.

Lead-II-acetate. *Plumbous acetate; Sugar of lead*

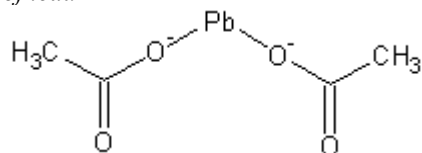

Lead-II-acetate

Lead-II-acetate occurs as the trihydrate, which forms colorless crystals or white granules or powder. It has a slight acetic odor, and is poisonous. Lead-II-acetate takes up carbon dioxide from the air, and therefore becomes insoluble in water. It has a melting point of 75 Celsius when rapidly heated, and begins to decompose at 100 Celsius. Decomposition of lead-II-acetate is complete above 200 Celsius. It is soluble in water, slightly soluble in alcohol, but freely soluble in glycerol. Keep bottles well closed. Lead-II-acetate is a carcinogen so handle with care. It can be prepared by heating acetic acid with lead-II-oxide, but is commercially available.

Lead-II-hydroxide

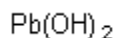

Lead-II-hydroxide

Lead-II-hydroxide forms a white powder, which readily absorbs carbon dioxide from the air. The exact structure of Lead-II-hydroxide indicates more of a lead-II-oxide hydrate; nevertheless, lead-II-hydroxide is prepared by mixing solutions of sodium hydroxide and lead-II-acetate by adding drop wise, the sodium hydroxide solution into the lead-II-acetate solution. The precipitated lead salt is then quickly filtered-off. Lead-II-hydroxide is insoluble in water, but soluble in dilute acids, and alkali hydroxide solutions.

Lead nitrate. *Lead-II-nitrate*

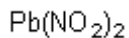

Lead Nitrate

Lead nitrate forms white or colorless translucent crystals. Lead nitrate is poisonous and ingestion causes illness related to other lead compounds. Lead nitrate is soluble in water making it one of the few lead compounds capable of dissolving in water. Lead nitrate is insoluble in alcohol, and concentrated nitric acid. It is prepared by reacting dilute nitric acid with lead oxides formed by the electrolysis of a magnesium sulfate/sodium chloride solution using lead electrodes. It is commercially available. Note: A lead nitrate explosive was used to damage the World Trade Center building in 1993.

An important explosive composition of lead nitrate

LNFO. *Lead nitrate fuel-oil explosive*

Thoroughly blend 96 grams of lead nitrate with 4 grams of diesel fuel oil at room temperature, for several hours to provide a well-mixed fuel balanced explosive. The resultant mixture will be in the form of a tacky, water impermeable slurry. Use the slurry directly and do not allow it to dry. Pack the slurry tightly into any desirable mold, container, bomb casing, or warhead casing under mild pressure (by-hand). Requires a powerful blasting cap or detonator for initiation (a nitroglycerine based detonator is preferred). LNFO has great heaving action and is therefore well suitable for demolitions purposes

Mercury-II-nitrate

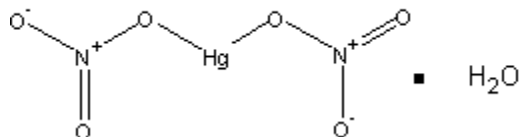

Mercury-II-nitrate

Mercury-II-nitrate forms white or slightly yellow, deliquescent crystals or powder with an odor of nitric acid. It is poisonous. It is only slightly soluble in water, and decomposes when kept with large amounts of water, or when boiled with water. Mercury-II-nitrate is soluble in dilute acids. Keep the salt stored in airtight bottles and protected from light.

Mercury-II-oxide, yellow



Mercury oxide

Mercury oxide is a yellow, or orange-yellow, heavy, odorless powder, or orthorhombic crystals. The oxide becomes red on heating, and then yellow again upon cooling. Mercury oxide is poisonous, and should not be handled by bare hands. Avoid inhalation of dust. It is prepared by heating mercury with dry oxygen for a long period of time. Mercury oxide should be protected from light.

Methyl acetate

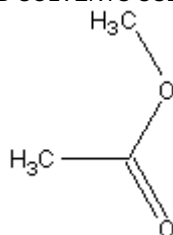

Methyl acetate

Methyl acetate forms a colorless liquid with a pleasant odor. It has a melting point of -98 Celsius, and a boiling point of 57 Celsius. It is soluble in water, and miscible with alcohol and ether. Methyl acetate is irritating to the nose and throat. Over exposure may cause headache, drowsiness, and skin contact may cause irritation. It can be prepared by distilling a mixture of methanol with acetic acid in the presence of a small amount of sulfuric acid.

Methylene iodide



Methylene iodide

Methylene iodide is a very heavy, highly refractive liquid, which darkens on exposure to light, air, and moisture. It has a melting point of 6 Celsius, and a boiling point of 181 Celsius. Methylene iodide is insoluble in water, but is miscible with alcohol, hexane, cyclohexane, ether, chloroform, and benzene. It dissolves sulfur and phosphorus. Methylene iodide is prepared by reacting iodoform with sodium arsenite, or by heating iodoform with sodium acetate in 95% ethanol.

NIHT.HCl. 2-nitroimino-hexahydro-1,3,5-triazine hydrochloride

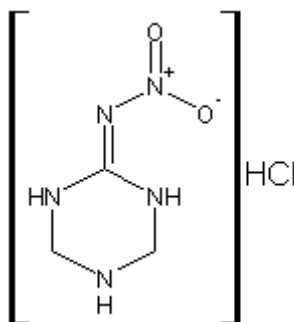

NIHT.HCl

Materials:	1. 1500 milliliters of 35 – 38% hydrochloric acid
	2. 82 grams nitroguanidine
	3. 200 grams hexamine
	4. 200 milliliters of methanol

Summary: NIHT.HCl is prepared by reacting nitroguanidine with hexamine in the presence of concentrated hydrochloric acid. The reaction mixture is then stirred over night, whereupon the NIHT.HCl precipitates. It is then collected by filtration, washed, and then dried. Commercial & Industrial note: For related, or similar information, see Application No. 446,357, December 5, 1989, by Aerojet General Corporation, to Der-Shing Huang, Carmichael, CA, Renato R.Rindone, Fair Oaks, CA. Part or parts of this laboratory process may be protected by international, and/or commercial/industrial processes. Before using this process to legally manufacture the mentioned compound, with intent to sell, consult any protected commercial or industrial processes related to, similar to, or additional to, the process discussed in this procedure. This process may be used to legally prepare the mentioned compound for laboratory, educational, or research purposes.

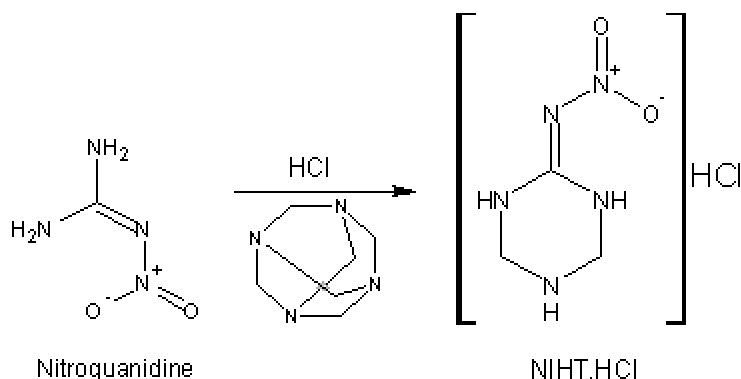

Reaction Equation

Hazards: Use proper ventilation when handling concentrated hydrochloric acid; the acid is highly corrosive and tends to linger in poor ventilated areas.

Procedure: To a 3-neck 2000-milliliter flask fitted with a condenser, a magnetic stirrer, and thermometer, add 1500 milliliters of 35 to 38% hydrochloric acid. Then add 82 grams of nitroguanidine in one portion, and then stir the mixture for 1 hour to completely dissolve the nitroguanidine. After the nitroguanidine has dissolved, add 200 grams of hexamine in several portions over a 40-minute period (during which time a slight heat increase will occur, raising the reaction temperature from room temperature to 38 Celsius). Note: after the addition of the hexamine, seal the apparatus from the atmosphere to protect the reaction mixture from oxygen, which can possibly damage the reaction. Upon completion of the hexamine addition, stir the reaction mixture at room temperature overnight. Then filter-off the precipitated product, wash with 200 milliliters of methanol, and then vacuum dry or air-dry. The resulting product will weigh 103.24 grams, and will have a melting point of 189 Celsius (with decomposition).

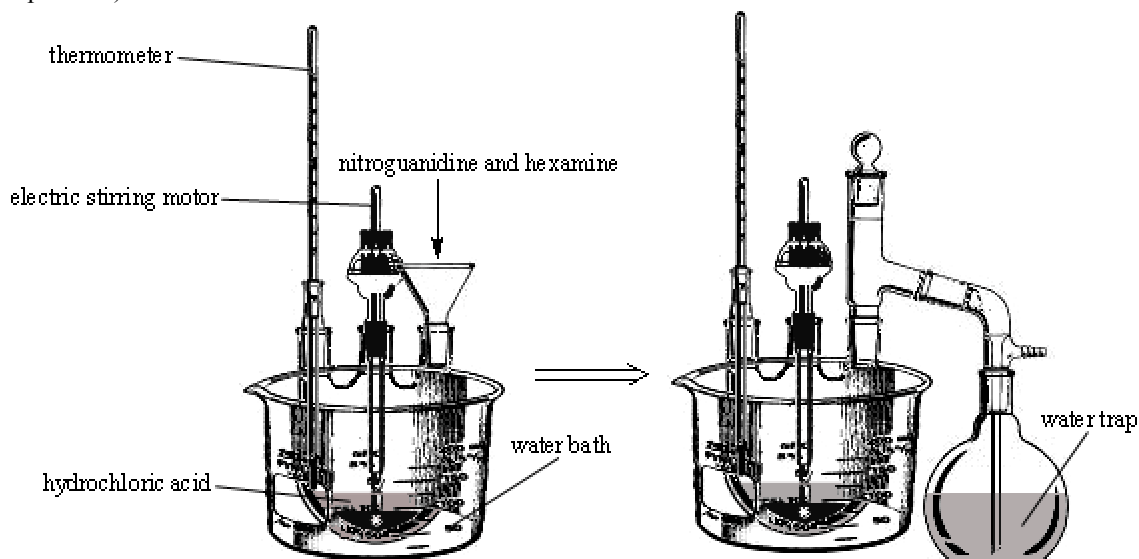

Figure 032. Setup for NIHT.HCl preparation. Left illustration: Apparatus during addition of nitroguanidine and hexamine. Right illustration: Identical apparatus but with water trap to keep the air out.

70% Nitric acid *Aquafortis*; *Salpetersaure*



Nitric acid

70% Nitric acid is referred to as concentrated nitric acid, and has a concentration of 65 to 71% nitric acid by weight (simply called 70% nitric acid). 70% nitric acid is a colorless liquid, which fumes in moist air yielding a choking vapor. Its melting point is -41 Celsius with a boiling point of 85 Celsius. When boiling 70% nitric acid, it forms a constant boiling mixture with water forming 68% nitric acid with a boiling point of 120 Celsius. 70% nitric acid should be stored in airtight glass bottles

away from sunlight. It stains fabrics, and animal tissue a bright yellow. In contact with the skin, it produces a yellow stain. 70% Nitric acid is a powerful oxidizing acid. It reacts violently with many different substances including alcohols, turpentine, charcoal, and organic refuse. 70% Nitric acid begins to turn yellow in contact with strong light sources such as sunlight or magnesium light. 70% Nitric acid is a widely available commercial acid. It is the 7th largest manufactured chemical in the US. Many chemical dealers will not sell 70% nitric acid to unlicensed persons because of its use in manufacturing high explosives. The US government has strong controls over its sale. Although, other methods of obtaining 70% nitric acid are discussed in this manual. *Note: information-right-to-know laws as outlined in the United States Constitution protect the information pertaining to the production of 70% nitric acid discussed in this manual.* Concentrated nitric acid is prepared on an industrial scale by the oxidation of ammonia with air in a special ammonia burner, utilizing platinum as catalyst. *Wear gloves and use proper ventilation when handling 70% nitric acid. 70% Nitric acid can cause skin burns and can chemically react with clothing. Use caution when handling.*

Alternative method for preparing 65 to 70% nitric acid

Summary: 70% Nitric acid can be obtained by treating potassium or sodium nitrate with sulfuric acid, mixing with water, and then extracting the acid mixture with methylene chloride. The result is a methylene chloride solution containing 99% nitric acid. This methylene chloride/99% nitric acid solution is then mixed with a calculated amount of water, and then carefully distilled to remove the methylene chloride and leave behind 70% nitric acid.

Hazards: methylene chloride/99% nitric acid mixture is very volatile and dangerous. 99% nitric acid is highly toxic, and corrosive. Perform the distillation using proper ventilation, and protect from direct sun light.

Procedure: Place 194 grams of 98% sulfuric acid into a beaker, and then place the beaker in a ice bath and cool to 0 Celsius. When the sulfuric acid reaches a temperature of 0 Celsius, slowly add in portions, 100 grams of potassium nitrate or 84 grams of sodium nitrate over a period of 1 hour while stirring the sulfuric acid and maintaining its temperature at 0 Celsius. After the addition of the potassium or sodium nitrate, slowly add over a period of one hour, 260 milliliters of cold water while continuously stirring the sulfuric acid mixture and maintaining its temperature at 0 Celsius (note: a precipitate may form before or after the addition of the water. If a precipitate forms, never mind it). Afterwards, remove the ice bath and then extract the acid mixture with seven 150-milliliter portions of methylene chloride. Then combine all seven portions of methylene chloride (if not already done so), and then add 27 milliliters of water to the methylene chloride. Next, place the entire methylene chloride (two phase) mixture into a distillation apparatus and carefully distill at 40 Celsius until no more methylene chloride is collected in the receiver flask. *Note: After all the methylene chloride has been removed, the 70% nitric acid may have a slight yellowish to red tint. If this is the case, don't worry. Go ahead and use this nitric acid as 70% nitric acid.*

99%+ Anhydrous nitric acid (absolute nitric acid)

99% nitric acid is a colorless (when freshly prepared), highly fuming, and poisonous liquid. It turns yellow to dark-red on standing, and has a melting point of -41.59 Celsius. 99% nitric acid is a powerful oxidizer. It reacts violently with many substances. 99% nitric acid should be used right after preparation. 99% Nitric acid is commercially available, but shipping regulations restrict its shipment to most locations. *Warning! 99% Nitric acid is very poisonous, and corrosive liquid which evolves large amounts of poisonous fumes. Wear gloves and proper laboratory clothing (lab coat; boots, face shield) when handling this substance and use maximum ventilation.*

Materials:	1. 106 milliliters 70% nitric acid
	2. 94 milliliters 98% sulfuric acid
	3. 1400 milliliters methylene chloride

Summary: 99% Nitric acid can be prepared from 70% nitric acid or any other lower concentration of nitric acid by adding the nitric acid to excess sulfuric acid, and then extracting with methylene chloride. The upper methylene chloride layer is recovered, and then carefully distilled at 40 Celsius to remove the methylene chloride and recover the 99% nitric acid. Commercial & Industrial note: For related, or similar information, see Application No. 549,198, February 12, 1975, by Koppers Company, Inc., to Clifford L. Coon, Menlo Park, CA. Part or parts of this laboratory process may be protected by international, and/or commercial/industrial processes. Before using this process to legally manufacture the mentioned substance, with intent to sell, consult any protected commercial or industrial processes related to, similar to, or additional to, the process discussed in this procedure. This process may be used to legally prepare the mentioned substance for laboratory, educational, or research purposes.

Hazards: Carryout the distillation with extreme caution. Do not heat the methylene chloride/nitric acid mixture above 40 Celsius, and use proper ventilation. Nitrogen oxide gases will develop so be prepared. Carryout the distillation away from direct sun light.

Procedure: Into an appropriate sized beaker place 94 milliliters of 98% sulfuric, and then 106 milliliters of 70% nitric acid. Then extract this acid mixture with seven 200-milliliter portions of methylene chloride. Afterwards, combine all seven portions of methylene chloride (if not already done so). The result will be a 99% nitric acid solution in methylene chloride. This methylene chloride/nitric acid mixture can be used directly in nitrations (if desired), or separated to recover pure 99% nitric acid. To separate the mixture, place the mixture into a distillation apparatus, and then carefully distill at 40 Celsius until no more methylene chloride is collected in the receiver flask. *Note: Take caution when distilling and use proper ventilation because decomposition of the nitric acid might result forming reddish-brown fumes of nitrogen oxides. If the nitric acid begins to decompose during the distillation, don't worry and continue the distillation. After all the methylene chloride has been removed, the result might be a reddish-brown highly fuming liquid. This reddish-brown fuming liquid is suitable for use as 99% nitric acid.*

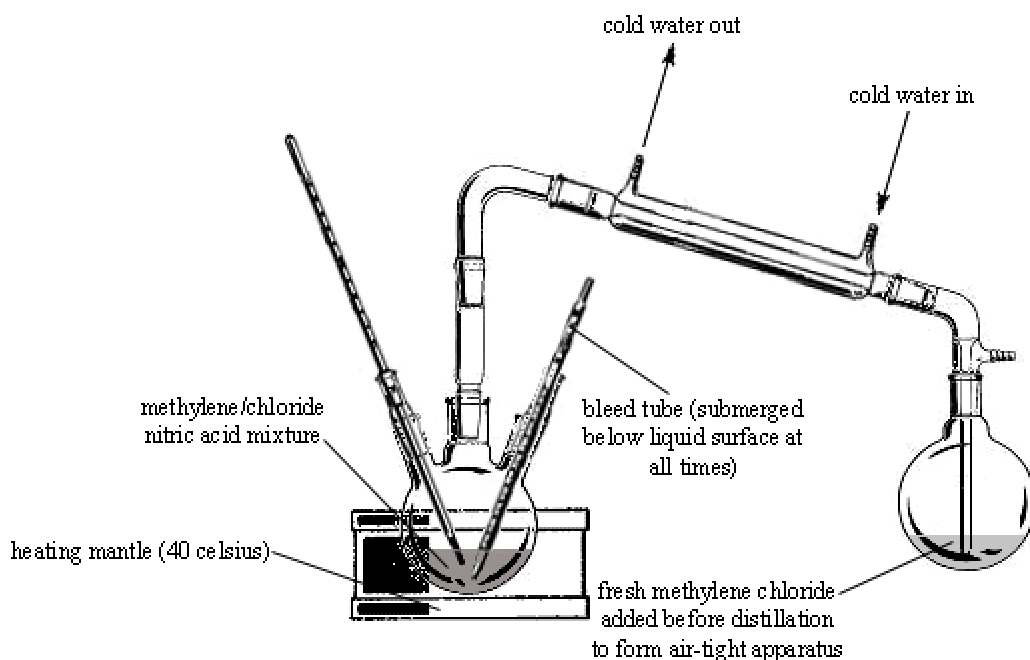

Figure 033. Apparatus for the distillation of methylene chloride to collect pure nitric acid

Note: Any concentration of nitric acid can be used instead of just 70% nitric acid. When using nitric acid concentrations below 70% by weight, simply mix the dilute nitric acid with excess sulfuric acid. For example, mix 57 grams of 98% sulfuric acid with 53 milliliters of 60% nitric acid, mix 67grams of 98% sulfuric acid with 53 milliliters of 50% nitric acid, mix 77 grams of 98% sulfuric acid with 53 milliliters of 40% nitric acid, mix 87 grams of sulfuric acid with 53 milliliters of 30% nitric acid, mix 97 grams of 98% sulfuric acid with 53 milliliters of 20% nitric acid, or mix 107 grams of 98% sulfuric acid with 53 milliliters of 10% nitric acid. After one of these mixings, extraction with methylene chloride with seven 100-milliliter portions is the next step. The result is the same as in the above procedure. To isolate the 99% nitric acid, follow the directions in the above procedure.

Alternative method for preparing 99% nitric acid

Summary: 99% Nitric acid can also be obtained by treating potassium or sodium nitrate with sulfuric acid, adding water, and then extracting the acid mixture with methylene chloride to form a solution of 99% nitric acid in methylene chloride. The methylene chloride is then carefully distilled off to recover the pure 99% nitric acid.

Hazards: Take caution when distilling and use proper ventilation because decomposition of the nitric acid might take place forming reddish-brown fumes of nitrogen oxides. If the nitric acid begins to decompose during the distillation, don't worry and continue the distillation. After all the methylene chloride has been removed, the result might be a reddish-brown highly fuming liquid. This reddish-brown fuming liquid is suitable for use as 99% nitric acid. Carryout the distillation with extreme caution. Do not heat the methylene chloride/nitric acid mixture above 40 Celsius, and use proper ventilation. Nitrogen oxide gases will develop so be prepared. Carryout the distillation away from direct sun light.

Procedure: Place 194 grams of 98% sulfuric acid into a beaker, and then place the beaker in a ice bath and cool to 0 Celsius by means of an ice bath. When the sulfuric acid reaches a temperature of 0 Celsius, slowly add in portions, 100 grams of potassium nitrate or 84 grams of sodium nitrate over a period of 1 hour while stirring the 98% sulfuric acid and maintaining its temperature at 0 Celsius. After the addition of the potassium or sodium nitrate, slowly add over a period of one hour, 260 milliliters of cold water while continuously stirring the 98% sulfuric acid mixture and maintaining its temperature at 0 Celsius. Afterwards, remove the ice bath and then extract the acid mixture with seven 150-milliliter portions of methylene chloride. Then combine all seven portions of methylene chloride (if not already done so), and then place the methylene chloride into a distillation apparatus and carefully distill at 40 Celsius until no more methylene chloride is collected in the receiver flask.

90% fuming nitric acid

90% Nitric acid is a yellow to brownish-red, strongly fuming liquid. 90% Nitric acid is a very poisonous and corrosive liquid, which evolves poisonous, choking fumes of nitrogen oxides. It is a powerful oxidizer, and should be kept stored in glass, or Teflon containers, in a cool dry place and away from light (preferably in a refrigerator). 90% Nitric acid reacts violently with many substances. 90% Nitric acid is commercially available, but shipping regulations may limit its sale.

Method of preparing 90% nitric acid

Summary: 90% Nitric acid can be obtained by treating potassium or sodium nitrate with sulfuric acid, mixing with water and then extracting the acid mixture with methylene chloride. The result is a methylene chloride solution containing 99% nitric acid.

This methylene chloride/99% nitric acid solution is then mixed with a calculated amount of water, and then distilled to remove the methylene chloride and produce 90% nitric acid.

Hazards: Take caution when distilling and use proper ventilation because decomposition of the nitric acid might take place forming reddish-brown fumes of nitrogen oxides. If the nitric acid begins to decompose during the distillation, don't worry and continue the distillation. After all the methylene chloride has been removed, the result might be a reddish-brown highly fuming liquid. This reddish-brown fuming liquid is suitable for use as 90% nitric acid. Carryout the distillation with extreme caution. Do not heat the methylene chloride/nitric acid mixture above 40 Celsius, and use proper ventilation. Nitrogen oxide gases will develop so be prepared. Carryout the distillation away from direct sun light.

Procedure: Place 194 grams of 98% sulfuric acid into a beaker, and then place the beaker in an ice bath and cool to 0 Celsius. When the sulfuric acid reaches a temperature of 0 Celsius, slowly add in portions, 100 grams of potassium nitrate or 84 grams of sodium nitrate over a period of 1 hour while stirring the sulfuric acid and maintaining its temperature at 0 Celsius. After the addition of the potassium or sodium nitrate, slowly add over a period of one hour, 260 milliliters of cold water while continuously stirring the sulfuric acid mixture and maintaining its temperature at 0 Celsius (note: a precipitate may form before or after the addition of the water. If this is happens, never mind it). Then remove the ice bath and then extract the acid mixture with seven 150-milliliter portions of methylene chloride. Afterwards, combine all seven portions of methylene chloride (if not already done so), and then add 7 milliliters of water to the methylene chloride. Then place the entire methylene chloride (two phase) mixture into a distillation apparatus and carefully distill at 40 Celsius until no more methylene chloride is collected in the receiver flask.

60% Nitric acid

Prepare by mixing 100 grams of 70% nitric with 15 milliliters of water.

55% Nitric acid

Prepare by dissolving 100 grams of 70% nitric acid into 27 grams of water.

26% Nitric acid

Prepare by Dissolving 100 grams 70% nitric acid into 160 milliliters of water.

33% Nitric acid

Prepare by diluting 200 milliliters of 70% nitric acid with 225 milliliters of water

16% Nitric acid

Prepare by dissolving 100 grams of 70% nitric into 335 milliliters of water.

2% Nitric acid

Prepare by diluting 100 grams of 70% nitric acid into 3370 milliliters of water.

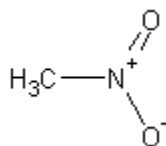
Nitromethane

Nitromethane

Nitromethane is an oily liquid with a strong odor. It is highly flammable, and has a melting point of -29 Celsius with a boiling point of 101 Celsius. Nitromethane is not very soluble in water, but is soluble in alcohol, ether, and DMF. It can form explosive salts with sodium, which ignite in contact with water. Nitromethane is used in liquid rocket fuels, and is produced on an industrial scale from vapor-phase oxidation of propane with nitric acid vapor. Nitromethane can be prepared on a laboratory scale by mixing sodium nitrite with sodium chloroacetate. Nitromethane is widely available commercial chemical.

Nitrosonium tetrafluoroborate. *Nitrosyl tetrafluoroborate*

Nitrosonium tetrafluoroborate

Nitrosonium tetrafluoroborate forms birefringent, orthorhombic, hygroscopic platelets, which decompose by water. It may be stored in glass bottles if dry, and is prepared by reacting sodium tetrafluoroborate with dinitrogen trioxide. Nitrosonium tetrafluoroborate is commercially available.

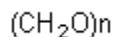
Paraformaldehyde. *Polyoxymethylene; Paraform; Triformol*

Paraformaldehyde

Paraformaldehyde is a white crystalline powder with an odor of formaldehyde. It is slowly soluble in cold water, and more readily soluble in hot water with evolution of formaldehyde. It is insoluble in alcohol, and ether. Keep paraformaldehyde in tightly sealed bottles. Paraformaldehyde is prepared by the polymerization of formaldehyde, and is commercially available.

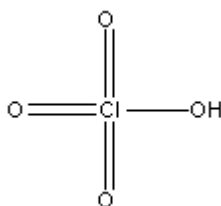
Perchloric Acid

Perchloric Acid

The anhydrous acid is a colorless, volatile, liquid. The acid decomposes when distilled at atmospheric pressure, sometimes explosively; can be distilled under vacuum. Perchloric acid is usually sold as a aqueous solution containing 60 to 70% perchloric acid by weight, and concentrated perchloric acid refers to 70% perchloric acid by weight. The acid produces much heat when dissolved in water, and acid solutions can deflagrate in the presence of certain organic materials; especially if mixed with oxidizable substances such as alcohols, aldehydes, or amines. All of the salts of perchloric acid are highly explosive. Wear gloves when handling the acid; causes skin burns and irritation. Acid vapors are irritating to the mucous membranes. Note: concentrated perchloric acid should be handled with great care at all times.

Perchloryl fluoride

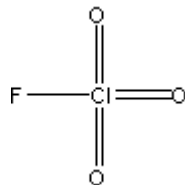

Perchloryl fluoride

Perchloryl fluoride is a non corrosive gas with a sweet taste. It has a melting point of -148 Celsius and a boiling point of -47 Celsius. Perchloryl fluoride is a very stable gas at room temperature. Explosions will result if perchloryl fluoride is treated with reducing agents such as amides, powdered metals, hydrides, sulfites, phosphites, phosphides, or hydrazines or when treated with alcohols. Avoid skin contact and inhalation.

11.2% potassium hydroxide in methanol solution

Prepare by dissolving 11.2 grams of potassium hydroxide into 88.8 grams of 99% methanol.

Semicarbazide hydrochloride

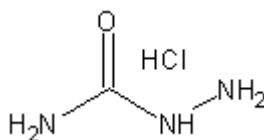

Semicarbazide hydrochloride

Semicarbazide hydrochloride forms prisms when recrystallized from dilute alcohol. It decomposes when heated to 175 Celsius. Semicarbazide hydrochloride is freely soluble in water, and is available commercially.

Materials:	1. 120 grams Urea
	2. 110 grams of a 64% hydrazine solution
	3. 630 milliliters of methanol
	4. 74 grams anhydrous hydrogen chloride

Summary: Semicarbazide hydrochloride is prepared by reacting urea with hydrazine, and then treating the freebase with hydrogen chloride to form the hydrochloride of semicarbazide. Commercial & Industrial note: For related, or similar information, see Application No. 519,471, August 1, 1983, by Olin Corporation, to Eugene F. Rothgery, North Branford, CT. Part or parts of this laboratory process may be protected by international, and/or commercial/industrial processes. Before using this process to legally manufacture the mentioned compound, with intent to sell, consult any protected commercial or industrial processes related to, similar to, or additional to, the process discussed in this procedure. This process may be used to legally prepare the mentioned compound for laboratory, educational, or research purposes.

Hazards: Use caution when handling concentrated hydrazine solutions; never boil them alone, and keep them away from strong oxidizers. Use proper ventilation when handling anhydrous hydrogen chloride; fumes are very irritating and corrosive.

Procedure: Place 120 grams of urea and 110 grams of a 64% hydrazine water solution into a 500-milliliter flask, and then heat the flask to 115 Celsius and reflux for 6 hours. Use proper ventilation as ammonia gas is evolved during this period. After refluxing for 6 hours, remove the heat source, and allow the mixture to cool to room temperature. Afterwards, pour the reaction mixture into a shallow pan with a high surface area and allow it to evaporate to dryness. When dry solid remains, collect the dry solid and then place it into 400 milliliters of methanol. After which, heat the mixture at 60 Celsius for 90 minutes while stirring, and then remove the heat source and allow the semicarbazide mixture to cool to room temperature. Then, filter-off the insoluble hydrazodicarbonamide by-product (5.5 grams). Afterwards, prepare a solution by bubbling 74 grams of anhydrous hydrogen chloride into 130 milliliters of methanol. Then cool the filtered semicarbazide mixture to 10 Celsius by means of an ice water bath. When the temperature reaches 10 Celsius, rapidly add the hydrogen chloride/methanol solution while stirring the semicarbazide solution. After addition of the hydrogen chloride/methanol solution, filter-off the precipitated product, wash with 100 milliliters of methanol, and then vacuum dry or air-dry.

Silver-I-oxide

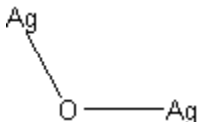

Silver oxide

Silver oxide forms a brownish-black, odorless powder with a decomposition point of 200 Celsius. Sunlight catalyzes the break down into silver and oxygen. Silver oxide is also easily decomposed by hydrogen, carbon monoxide, and many metals. It is insoluble in water, but is freely soluble in ammonia and dilute nitric acid with formation of salts. It is prepared by treating a silver nitrate solution with sodium hydroxide.

Silver perchlorate

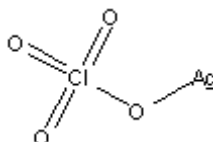

Silver perchlorate

Silver perchlorate forms deliquescent crystals, which decompose when heated to 486 Celsius. It is freely soluble in water; saturated solution contains 85% by weight silver perchlorate making it one of the most water soluble compounds known; lithium perchlorate being number 1. It is also soluble in aniline, pyridine, benzene, nitromethane, glycerol, and chlorobenzene. It can form solvated crystals with aniline, benzene, and toluene; all explode on percussion. Silver perchlorate forms a hydrate, which melts at 43 Celsius. It can be made by reacting sodium hypochlorite (bleach) with silver bromide.

30% Sodium azide

Prepare by dissolving 100 grams of sodium azide into 230 milliliters of water.

14% Sodium carbonate

Prepare by dissolving 100 grams of sodium carbonate into 600 milliliters of water.

Sodium hydroxide



Sodium hydroxide

Sodium hydroxide forms fused solid pieces, granules, rods, or powder. It rapidly absorbs moisture and carbon dioxide from the air. Solutions of sodium hydroxide are very corrosive to animal tissue, and aluminum. It has a melting point of 318 Celsius. Sodium hydroxide is very soluble in water and alcohol. It generates large amounts of heat when dissolving in water, or when mixed with acid. Sodium hydroxide is toxic. Handle sodium hydroxide with care. Sodium hydroxide is a widely available commercial chemical, which is sold under a variety of names such as “Lye”. Sodium hydroxide is prepared on an industrial scale in a procedure called the “chloro-alkali” process. In the chloro-alkali process, a sodium chloride solution is electrolyzed in a special cell composed of two compartments separated by a porous membrane. Chlorine gas is produced at the positive anode, and sodium hydroxide forms at cathode.

Process for the preparation of sodium hydroxide

Summary: Sodium hydroxide can be prepared by electrolyzing a sodium chloride solution in a two-compartment cell separated by a porous membrane. Chlorine gas is liberated at the positive anode and hydrogen and sodium hydroxide are liberated at the cathode. *Use proper ventilation when running the electrolysis cell because of chlorine and hydrogen gas evolution. Run the cell in an area that is away from direct sunlight.*

Hazards: Chlorine gas is produced in this procedure; either properly vent the gas, or neutralize it by bubbling it through a sodium hydroxide or sodium carbonate solution. Carryout this procedure away from direct sun-light, and keep any source of ignition away; hydrogen gas is very flammable and explosive.

Procedure: Prepare a cell shown in figure 034, and then add 500 grams of table salt (sodium chloride preferable sold under the name “pickling salt”) to a beaker and then add 1500 milliliters of water. Then stir the mixture to dissolve the table salt. After which, pour 1000 milliliters of water into the apparatus anode compartment. Then pour about 100 milliliters of the sodium chloride solution into the anode compartment to bring its total volume to about 1100 milliliters. Afterwards, pour the rest of the sodium chloride solution into the apparatus cathode compartment. Then put the graphite electrodes in place and electrolysis at 12-amp/12-volt until no more chlorine gas is evolved. When no more chlorine is evolved, stop the electrolysis. Then pour the cathode liquid into a beaker, and then filter to remove any insoluble materials. After filtering, pour the sodium hydroxide solution into a clean stainless steel beaker and then boil-off the water until dry sodium hydroxide solid remains. Do not use glass when boiling-off the water because the sodium hydroxide will corrode the glass and cause it to break.

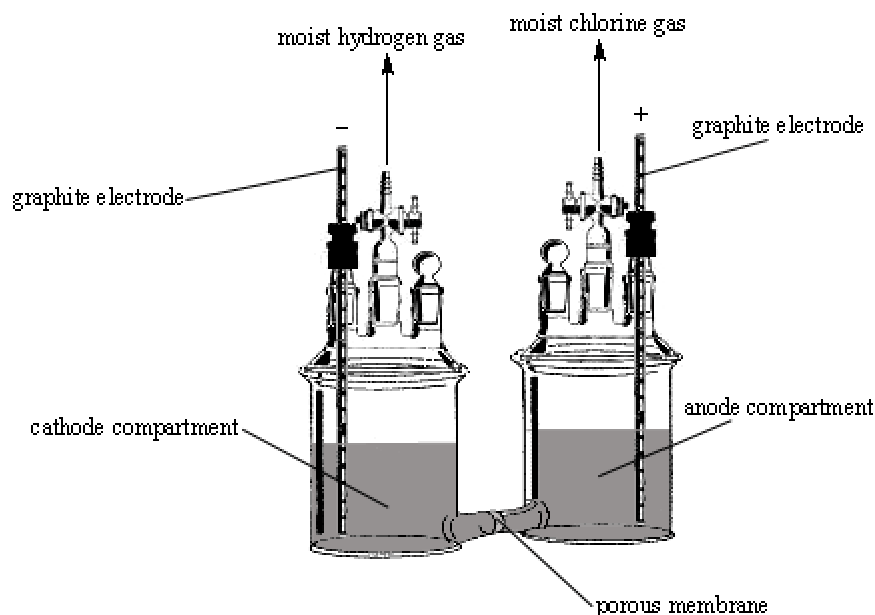

Figure 034. Apparatus for the production of sodium hydroxide. Chlorine gas is liberated at the positive anode electrode, and hydrogen gas is liberated at the negative cathode electrode. The sodium hydroxide is formed at the negative cathode electrode and remains dissolved in water.

15% Sodium hydroxide

Prepare by dissolving 100 grams of sodium hydroxide into 570 milliliters of water.

10% Sodium hydroxide

Prepare by dissolving 10 grams of sodium hydroxide into 90 milliliters of water.

26% Sodium nitrite solution

Prepare by dissolving 84 grams of sodium nitrite into 238 grams water.

10% Sodium nitrite solution

Prepare by dissolving 100 grams of sodium nitrite into 900 milliliters of water.

10% Sodium sulfite

Prepare by dissolving 10 grams of sodium sulfite into 90 milliliters of water.

Sulfur chloride

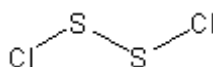

Sulfur chloride

Sulfur chloride forms a non-flammable, light amber to yellowish red, fuming oily liquid, which has a penetrating odor. It has a melting point of -77 Celsius, and a boiling point of 138 Celsius. It is soluble in alcohol, ether, carbon disulfide, toluene, carbon tetrachloride, and many oils. It reacts with water yielding sulfur dioxide, hydrogen chloride, and other products. Over exposure

may cause skin irritation. It is conveniently prepared by passing dry chlorine into molten sulfur, and then recovering the sulfur chloride by distillation under pressure.

80% Sulfuric acid

Prepare by dissolving 10 grams of 98% sulfuric acid into 2.5 milliliters of water. Much heat is evolved when dissolving 98% sulfuric acid into water, so allow the solution to cool before using.

70% Sulfuric acid

Prepare by dissolving 100 grams of 98% sulfuric acid into 40 milliliters of water (note: before using, allow it to cool because 98% sulfuric acid generates a large amount of heat when dissolving in water).

50% sulfuric acid

Prepare by dissolving 100 grams of 98% sulfuric acid into 100 grams of water.

25% Sulfuric acid

Prepare by dissolving 100 grams of 98% sulfuric acid into 300 milliliters of water.

30% Fuming sulfuric acid

30% Fuming sulfuric acid is a colorless, to slightly colored, viscous liquid. It evolves choking fumes of sulfur trioxide, and is an extremely corrosive liquid. Avoid contact with the skin, and keep away from rubber, resins, polymers, and organic refuse. 30% fuming sulfuric acid should be kept in glass-stoppered bottles, and when not in use keep the glass bottles in a plastic bag, and store in refrigerator. 30% Fuming sulfuric acid is commercially available, but shipping regulations may limit its sale. 30% Fuming sulfuric acid is prepared by passing sulfur trioxide into 98% sulfuric acid until the sulfuric trioxide content equals about 30% by weight. **Hazard:** Fuming sulfuric acid is a highly corrosive and toxic liquid evolving toxic and highly corrosive fumes of sulfur trioxide. Avoid contact with skin, clothing, wood, rubber, most plastics, sugar, and organic refuse. Fuming sulfuric acid can cause clothing to “melt” to the skin if spilled on. Use extreme caution at all times.

Sulfuryl chloride

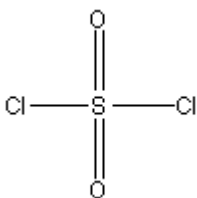

Sulfuryl chloride

Sulfuryl chloride forms a mobile, colorless liquid, which has an unpleasant pungent odor. The liquid and its vapors are corrosive to skin, tissue, hair, and mucous membranes. The liquid has a melting point of -54 Celsius, and a boiling point of 69 Celsius. It slowly turns yellow on standing, and decomposes slowly in water forming sulfuric acid and hydrogen chloride. It is made by mixing dry sulfur dioxide gas with dry hydrogen chloride gas, usually in the presence of activated charcoal. Sulfuryl chloride reacts violently on contact with alkalis.

TAT

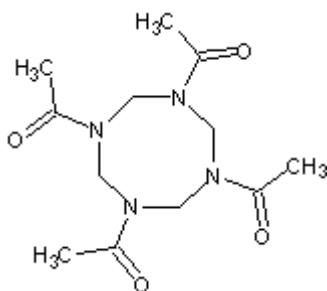

TAT

Materials:	1. 296 g DAPT
	2. 314 g acetic anhydride
	3. 50 g copper-II-oxide
	4. 200 milliliters of acetone

Summary: TAT is prepared by reacting DAPT with acetic anhydride in the presence of water. After reaction with acetic anhydride, a catalytic amount of copper-II-oxide is added to the reaction mixture to facilitate a conversion of the triacetyl intermediate, into the desired TAT product. The TAT product is then purified, and recrystallized from acetone to yield a high purity product. Commercial & Industrial note: For related, or similar information, see Application No. 476,947, January 3, 1999, by Schlumberger Technology Corporation, to William J. Lukasavage, Pearland, TX, Lawrence A. Behrmann, Houston, TX, and Wallace E. Voreck, Sparta, NJ. Part or parts of this process may be protected by international, and/or commercial/industrial processes. Before using this process to legally manufacture the mentioned compound, with intent to sell, consult any protected commercial or industrial processes related to, similar to, or additional to, the process discussed in this procedure. This process may be used to legally prepare the mentioned compound for laboratory, educational, or research purposes.

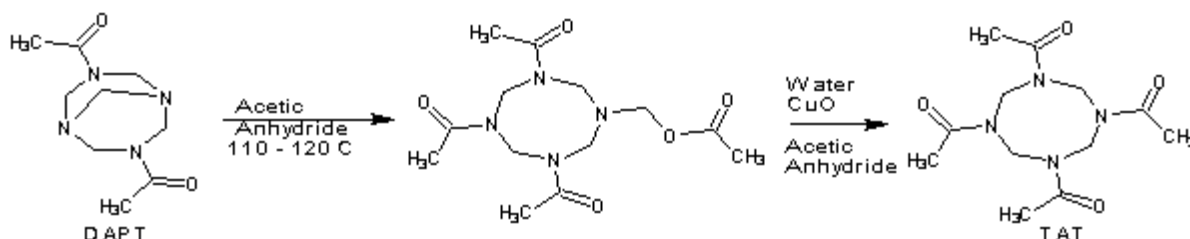

Reaction Equation

Hazards: Acetic anhydride is a fire hazard, as is acetone. Avoid contact of the vapors with fire, or electric discharges. Avoid skin contact with acetic anhydride; causes skin burns and/or irritation.

Procedure:

Step 1: Conversion of DAPT to the triacetyl intermediate

Place 296 grams of DAPT into a beaker and then rapidly add 314 grams of acetic anhydride and stir the mixture rapidly. After the addition of the acetic anhydride, heat the mixture to 110 Celsius for 4 hours (do not exceed 120 Celsius). After heating at 110 Celsius for 4 hours, remove the heat source, and allow the mixture to cool to room temperature.

Step 2: Conversion of the triacetyl intermediate to TAT

To the reaction mixture (prepared in step 1) add 50 grams of copper-II-oxide and then add 26 milliliters of water, and stir the reaction mixture for 20 minutes (note: A combination of copper oxide and iron oxide can be used as a catalyst in the reaction or the copper can be added in the form of copper wire, while the iron can be added in the form of steel wool). After stirring for 20 minutes, slowly add 30 milliliters of water over a period of approximately 180 minutes while stirring the reaction mixture. Afterwards, place the reaction mixture into a shallow pan and then heat this pan to 130 Celsius, and blow air over the surface of the pan (a portable cooling fan can be used). Continue heating for 4 hours at 130 Celsius. After 4 hours, reduce the heat to 70 Celsius, and continue blowing air over the surface of the pan for an additional 1 hour. After 1 hour, remove the heat source and the air flow, and then add 200 milliliters of acetone and thoroughly mix the solution for 20 minutes and then filter to remove any possible insoluble by-products (there may be no insoluble by-products). Then recrystallize the mixture, and then dry the product in an oven at 100 Celsius for 4 hours or until dry.

Trifluoroacetic acid

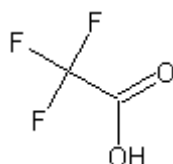

Trifluoroacetic acid Trifluoroacetic acid is a colorless liquid with a sharp biting odor. It has a boiling point of 72 Celsius, and a melting point of -15 Celsius. Trifluoroacetic acid is miscible with ether, ethanol, acetone, benzene, and hexane. It is a strong, non-oxidizing acid, which is commercially available but expensive.

Trioxane

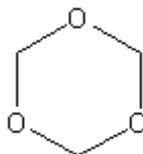

Trioxane

Trioxane is a stable, cyclic trimer of formaldehyde. It has chloroform like odor, and is a crystalline solid with a melting point of 64 Celsius, and a boiling point of 114.5 Celsius. It sublimates readily and is very soluble in water, acetone, alcohol, ether, and chlorinated hydrocarbon solvents. Trioxane forms an azeotrope when distilled with water, boiling at 91 Celsius, and containing 70% trioxane by weight. Trioxane slowly depolymerizes when treated with acids, and in the absence of water, it breaks down to monomeric formaldehyde when treated with acids. Trioxane is inert to alkalis. It is commercially available.

Materials:	1. 400 grams paraffin oil
	2. 320 grams 70% formaldehyde solution
	3. 10 grams (16 drops) 98% sulfuric acid
	4. 1600 milliliters methylene chloride

Summary: Trioxane is prepared by the polymerization of formaldehyde with a catalytic amount of sulfuric acid. Paraffin oil is used to stabilize the reaction, forming an emulsion. Commercial & Industrial note: Part or parts of this laboratory process may be protected by international, and/or commercial/industrial processes. Before using this process to legally manufacture the mentioned compound, with intent to sell, consult any protected commercial or industrial processes related to, similar to, or additional to, the process discussed in this procedure. This process may be used to legally prepare the mentioned compound for laboratory, educational, or research purposes.

Hazards: 70% Formaldehyde is a volatile, and fuming liquid. Use proper ventilation when handling, and avoid inhalation of the vapors. Wear gloves when handling 98% sulfuric acid, and avoid skin contact.

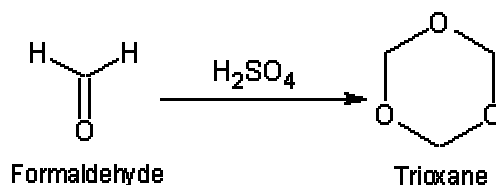

Reaction Equation

Procedure: Place 400 grams of paraffin oil into a flask equipped with a condenser and stirring bar and then heat to 90 Celsius. When the paraffin has melted, add 200 grams of 70% formaldehyde solution while maintaining the temperature at 90 Celsius and stirring. After the addition of the 70% formaldehyde, add 10 grams of 98% sulfuric acid while vigorous stirring the reaction mixture. After adding the 98% sulfuric acid, place the reaction mixture into a distillation apparatus and distill at 105 Celsius for 6 hours (Note: during the distillation process, add 40 grams of 70% formaldehyde in one portion to the distilling mixture once every 2 hours during the distillation. In other words, add 40 grams of 70% formaldehyde when the distillation begins. Then after the 2nd hour, add another 40 grams of 70% formaldehyde. Finally, add another 40 grams after the 4th hour). At the end of the distillation, the trioxane in the receiving flask will contain un-reacted formaldehyde, so place this mixture into a shallow pan and allow it to evaporate to dryness. When dry solid is obtained, recrystallize from 1600 milliliters of methylene chloride. After which, wash with 400 milliliters of water, and then vacuum dry or air dry.

IV

EXPLOSIVES AND EXPLOSIVE COMPOSITIONS

Now is the time to explore the world of explosives. From now on, you will be engulfed into an echelon of chemical reactions, procedures, processes, and the like. Follow all instructions carefully, and know exactly what are you doing before you do it. Please note that many of the following procedure involve very dangerous chemicals and intermediates. Some of them are highly toxic in nature, or are very reactive chemically. All reactions should be carried out with proper ventilation, as many of the reactions evolve toxic fumes of nitrogen oxides or other similar gases. As well as proper ventilation, reaction temperatures should be monitored at all times as specified by the hazards given in the procedures. Allowing reaction mixtures to reach temperatures other wise not specified in the procedures can lead to dangerous conditions. However, it should be noted that these “dangerous” conditions do not mean “explosions”. In most cases excessive temperatures will lead to decomposition of desired products, or dangerous evolutions of toxic, flammable, or corrosive gases.

Note: All detonating velocities are given in meters per second.

Note: Many of the procedures in this book use excessive amounts of chemicals. The reason is because for proper reaction rates and yields, excessive amounts of reagents and solvents are often used. In some of the procedures you will notice that excessive amounts of nitric acid are used. It should be noted that once again, for proper reactions and yields, the ratio of nitric acid to intermediate can be as high as 20 to 1 in some cases. Although excessive amounts of chemicals are used, most of these chemicals can be recovered and recycled for additional crops of desired product. Solvents especially can be recovered from reaction mixtures by simple distillations—and should be to save money. Some solvents can be quite expensive, and hence, should be recycled over and over again. Reagents such as acetic acid, acetic anhydride, and others can be recycled from reaction mixtures as well, and should as they too can be costly—solvent extractions and/or simple distillations can be used to recover these reagents.

Nitric acid is another expensive reagent, which can be hard to come by for many people, however, this compound when used in excessive amounts for proper reaction conditions, can be recovered and recycled as well. To recover excess nitric acid from reaction mixtures, the reaction mixture (after complete removal of the product) should be treated with sulfuric acid, if it does not already have any present, and the resulting reaction mixture extracted with several volumes (50, 100, 150, 250, or 500 milliliter volumes) of methylene chloride—the resulting volumes are then combined, and carefully distilled to remove the solvent and leave behind the nitric acid. In some cases, the procedures will give specific instructions for recovering the acid, or recycling the excessive amount.

You should be advised that in the real world this is how explosives are made. If you want good yields of product with high quality, it takes money, chemicals, and laboratory equipment. Even though some of the procedures in this book can be complicated and/or pain staking for most people to carryout, it should be recognized that these procedures are the best you will find anywhere, and to ensure proper reaction rates, and quality of products, the conditions set forth in each procedure are exact and definite.

Note: Many of the procedure in this book have been designed to operate not only on a laboratory scale, but an industrial scale as well. However, the industrial scale designs will not be discussed in this book as they deal with a whole new echelon of equipment, continuous flow mechanisms, recycling control devices, and other industrial issues. Although, the desired product can be increased in weight if desired by simply multiplying all intermediates, reagents, solvents, ect., ect., by the desired number of times. For example, if compound A specifies 40 grams, compound B specifies 35 grams, and compound C specifies 60 grams at a temperature of 20 Celsius for 2 hours to get 100 grams of product D—to double the amount of product D, simply multiple compound A, B, C, and the time by two, three, four, five, or however many of times desired. The temperature of reaction should be constant regardless of the mass units involved.

CHAPTER 4: THE PREPARATION OF METAL AZIDES, FULMINATES, AND NITRIDES

AZ, CZ, SZ, MZ, LZ, MERCURY FULMINATE, SILVER FULMINATE, COPPER FULMINATE, SILVER NITRIDE, MERCURY NITRIDE, SULFUR NITRIDE

4-01. AZ. Ammonium azide

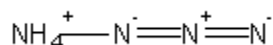

AZ

Ammonium azide forms non-hygroscopic, colorless plate-like crystals, which are very volatile. When a small amount of the salt is left out in the open, it will completely evaporate within a few days. Ammonium azide can be melted at 160 Celsius when gently heated. When heated to 160 Celsius, it begins to fizzle and sublime. When a small sample of the salt is heated rapidly, it explodes with a loud crack. Ammonium azide is primarily used in pyrotechnic compositions for airbags and other gas generators—it completely converts to gas upon ignition. It can be de-sensitized by mixing with calcium sulfate, tri sodium phosphate, dextrose, or gum Arabic. The pure crystals should be stored in a desiccator within a refrigerator.

Molecular weight: 60.06	Flammability: Explodes when ignited
Detonating velocity: Not calculated	Toxicity: Moderate
Sensitivity: Easily detonated	Classification: Primary explosive
Stability: Low	Overall value (as primary explosive): Moderate

Procedure 4-01A: Preparation of AZ

Materials:	1. 10 grams sodium azide
	2. 10 grams 28 – 30% ammonia or 30 grams of 10% ammonia (store bought ammonia; crystal clear ammonia) or 4 grams anhydrous ammonia

Summary: Ammonium azide is easily prepared by mixing solutions of sodium azide, and aqueous ammonia. The mixture is then treated with carbon dioxide gas to precipitate sodium ion as sodium bicarbonate. The remaining ammonium azide stays in solution, and can be recrystallized from the reaction mixture. The collected crystals should then be dried in a desiccator as vacuum drying may result in loss of product from volatilization; air-drying the solid may also lead to loss in product.

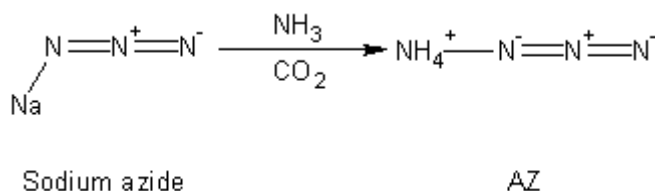

Reaction Equation

Hazards: Ammonia and its solutions are very irritating to the nose, throat, and mucous membranes. Use proper ventilation, and avoid inhalation of vapors.

Procedure: Prepare a solution of sodium azide in water by dissolving 10 grams of sodium azide into 23 milliliters of water at room temperature. Thereafter, rapidly add 10 grams of a 28 – 30% ammonia solution, or 30 grams of a 10% ammonia solution while stirring the sodium azide solution. Note: Instead of aqueous ammonia, 4 grams of anhydrous ammonia can be passed into the sodium azide solution. After the addition, place the mixture into an ice water bath, and then pass 50 to 80 grams of carbon dioxide into the mixture while stirring the mixture. During the addition, insoluble sodium bicarbonate will slowly precipitate. After the carbon dioxide has been added, place the reaction mixture into a freezer and chill at 0 Celsius for about ten minutes. Afterwards, filter-off the insoluble sodium bicarbonate, and then recrystallize the ammonium azide from the reaction mixture. After collecting the crystals, place the crystals into a desiccator filled with anhydrous sodium sulfate, and store in a refrigerator until use.

Notes:

4-02. CZ. Cupric azide; Copper-II-azide

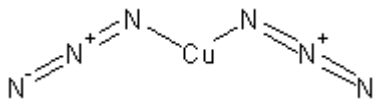

CZ

CZ forms brown crystals of anisotropic prisms, which are yellow in transmitted light. It is slightly soluble in water, forming a greenish solution. Boiling water decomposes CZ into hydrazoic acid, and copper hydroxide. CZ is very sensitive, and it easily detonates by shock, friction, sparks, percussion, or heat. Note: even dropping the solid from the filter paper can produce an explosion. Handle this substance with extreme care; prepare in small quantities only, and use proper shielding. The salt may contain water of hydration, but cannot be determined because of its sensitivity. The explosion by percussion is very violent. CZ shows sensitivity to that of mercury fulminate, but may be more sensitive than mercury fulminate. CZ is strictly used in making priming mixtures, and should be used as such immediately after preparation. It should be de-sensitized with dextrose, gum Arabic, starch, or chalk immediately after preparation and should not be stored dry.

Molecular weight: 147.592 (minus hydration)	Flammability: None (explodes when ignited)
Detonating velocity: Not calculated	Toxicity: Moderate
Sensitivity: Very easily detonated	Classification: Primary explosive
Stability: Very low	Overall value (as primary explosive): Low

Procedure 4-02A: Preparation of CZ

Materials:	1. 10 grams sodium azide
	2. 19 grams copper-II-sulfate pentahydrate

Summary: CZ is easily prepared by mixing solutions of sodium azide and copper sulfate. The precipitated product is then carefully filtered-off, washed, and dried in a desiccator.

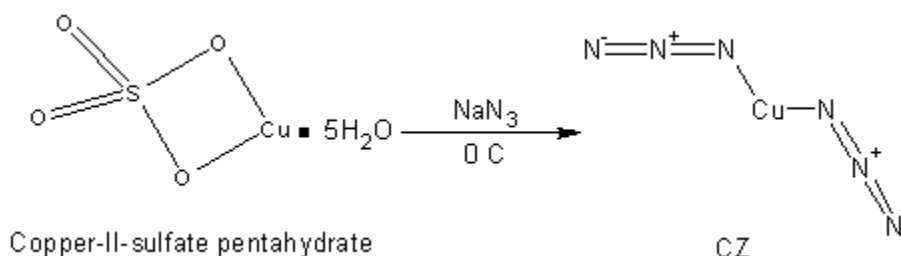

Reaction Equation

Hazards: Wear gloves when handling sodium azide. Sodium azide is highly poisonous, and can be absorbed through the skin.

Procedure: Prepare two solutions, a sodium azide solution, and a copper sulfate solution by dissolving 10 grams of sodium azide into 90 milliliters of water, and dissolve 19 grams of copper-II-sulfate pentahydrate into 161 milliliters of water. Then place each solution into a freezer and chill to about 5 Celsius. Thereafter, place the sodium azide into an ice bath, and then gradually add the copper-II-sulfate pentahydrate solution. Upon mixing, the CZ will instantaneously precipitate. After mixing both solutions, carefully filter-off the precipitated product, carefully wash with 100 milliliters of ice-cold water, and then dry in a desiccator filled with anhydrous magnesium sulfate. Do not vacuum dry or air-dry. The dry product should never be kept dry. For storage, keep the dry CZ suspended in a water free solvent such as kerosene.

Notes:

Cupric azide rim-fire priming mixture

Into a crucible, place 100 grams of glass powder, passed through a No. 100 US standard sieve, 4 grams of gum Arabic, and 60 grams of nitrocellulose. Then rapidly blend the mixture for 2 hours. Thereafter, slowly add 72 grams of freshly prepared wet cupric azide while gradually stirring the mixture. After all the cupric azide has been added, increase the blending speed, and thoroughly blend for 3 hours at room temperature. Then, place the mixture onto a shallow pan, and allow it to cure for several days. Afterwards, softly break-up the dry material, and then pack into any desirable primer (60 to 500 milligrams depending on the size of primer). This priming mixture may be used in place of mercury azide, and meets all environmental cleanliness standards for non-toxic priming mixtures.

4-03. SZ. *Silver azide*

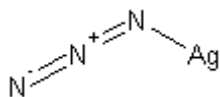

SZ

SZ forms colorless needle-like crystals or white powder with a melting point of 250 Celsius. It detonates when heated to 300 Celsius, or upon percussion. SZ is insoluble in water, and dilute acids, but soluble in concentrated mineral acids, and ammonia solutions. It is very sensitive to light, and breaks down into silver and nitrogen on standing—should be stored in amber glass bottles within a refrigerator. It is decomposed by boiling water and dilute sulfuric acid. Because of its surprising stability, SZ can be used as a substitute for LZ, or lead styphnate in blasting caps.

Molecular weight: 149.889	Flammability: Explodes when ignited
Detonating velocity: Not calculated	Toxicity: Moderate
Sensitivity: Easily detonated	Classification: Primary explosive
Stability: Moderately low	Overall value (as primary explosive): High

Procedure 4-03A: Preparation of SZ

Materials:	1. 26 grams silver nitrate
	2. 10 grams sodium azide

Summary: SZ is easily prepared by mixing solutions of sodium azide and silver nitrate. The precipitated product is then carefully filtered-off, washed, and dried in a dissector.

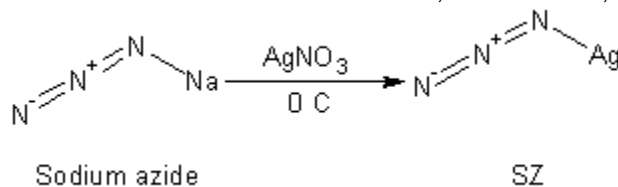

Reaction Equation

Hazards: Wear gloves when handling sodium azide. Sodium azide is highly poisonous, and can be absorbed through the skin.

Procedure: Prepare two solutions, a sodium azide solution, and a silver nitrate solution by dissolving 10 grams of sodium azide into 90 milliliters of water, and dissolve 26 grams of silver nitrate into 224 milliliters of water. Then place each solution into a freezer and chill to about 5 Celsius. Thereafter, place the sodium azide into an ice bath, and then rapidly add the silver nitrate solution. Upon mixing, the SZ will instantaneously precipitate. After mixing both solutions, carefully filter-off the precipitated product, carefully wash with 100 milliliters of ice-cold water, and then dry in a desiccator filled with anhydrous magnesium sulfate. Do not vacuum dry or air-dry. The dry product should never be kept dry. For storage, keep the dry SZ suspended in a water free solvent such as kerosene.

Notes:

4-04. MZ. Mercury Azide. *Precipitated mercury-II-azide*

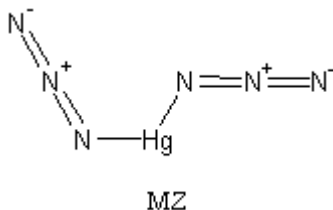

Mercury azide forms a white powder, which is insoluble in cold water, but relatively soluble in hot water. When gently heated to 212 Celsius, the salt begins to fizzle. The salt detonates if rapidly heated or when heated to 300 Celsius. The precipitated mercury azide is less sensitive than lead azide, but recrystallization of this precipitated form from hot water yields the very sensitive form of mercury azide (not prepared in this procedure). This recrystallized form is too unstable for use in priming mixtures or blasting caps, and its sensitivity is related to the ammonium iodide/nitrogen triiodide salt—can be detonated by a feather. The precipitated mercury azide however, can be used as an effective substitute for LZ in blasting caps.

Molecular weight: 284.630	Flammability: Explodes when ignited
Detonating velocity: Not calculated	Toxicity: High
Sensitivity: Easily detonated	Classification: Primary explosive
Stability: Moderate	Overall value (as primary explosive): Moderate

Procedure 4-04A: Preparation of MZ

Materials:	1. 25 grams mercury-II-nitrate
	2. 10 grams sodium azide

Summary: MZ is easily prepared by mixing solutions of sodium azide and mercury-II-nitrate. The precipitated product is then carefully filtered-off, washed, and dried in a desiccator. The dried product may contain some mercury nitrate, and/or mercury-II-oxide.

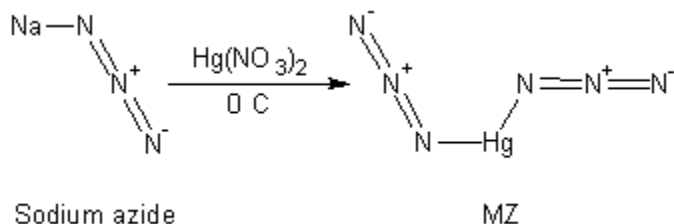
*Reaction Equation*

Hazards: Wear gloves when handling sodium azide and mercury-II-nitrate. Sodium azide and mercury-II-nitrate are highly poisonous, and can be absorbed through the skin.

Procedure: Prepare two solutions, a sodium azide solution, and a mercury-II-nitrate solution by dissolving 10 grams of sodium azide into 23 milliliters of water, and dissolve 25 grams of mercury-II-nitrate into 25 milliliters of water. Note: mercury-II-nitrate breaks down in the presence of excess water. If the bulk of the nitrate will not dissolve in the 25 milliliters of water, gradually add water drop by drop until it does. Then quickly place each solution into a freezer and chill to about 5 Celsius. Thereafter, place the sodium azide into an ice bath, and then rapidly add the mercury-II-nitrate solution. Upon mixing, the MZ will instantaneously precipitate. After mixing both solutions, carefully filter-off the precipitated product, carefully wash with three 100-milliliter portions of ice-cold water, and then dry in a desiccator filled with anhydrous magnesium sulfate. Do not vacuum dry or air-dry. The dry product should never be kept dry. For storage, keep the dry MZ suspended in a water free solvent such as kerosene.

Notes:

4-05. LZ. Lead azide; plumbous azide; lead-II-azide

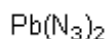

Lead azide

Lead azide forms needle like crystals, or a white powder. It begins to decompose when heated to 250 Celsius, and explodes when heated to 350 Celsius. Lead azide is more stable than mercury fulminate, and is an outstanding booster or transfer explosive found in blasting caps, detonators, and fuses. The salt is insoluble in water, but soluble in acetic acid. Lead azide is a standard military initiating explosive (mixed with dextrose to desensitize it).

Molecular weight: 291.242	Flammability: Explodes when ignited
Detonating velocity: 5000 (+ or - 15)	Toxicity: Moderate
Sensitivity: Easily detonated	Classification: Primary explosive
Stability: Moderate	Overall value (as primary explosive): High

Procedure 4-05A: Preparation of LZ

Materials:	1. 21 grams lead-II-acetate
	2. 8.3 grams sodium azide

Summary: Lead azide is easily prepared by mixing solutions of lead-II-acetate, and sodium azide. After the two solutions are mixed, the precipitated lead azide is then collected by filtration.

Hazards: Wear gloves when handling lead-II-acetate, and sodium azide. Lead-II-acetate is a suspected carcinogen. Sodium azide is poisonous so handle with care

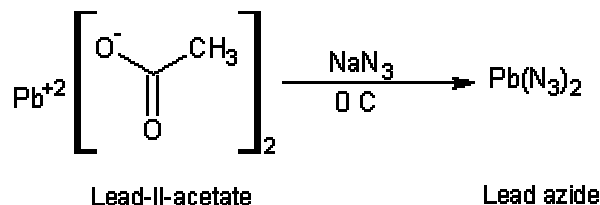
*Reaction Equation*

Procedure: Prepare two solutions, a sodium azide solution, and a lead-II-acetate solution by dissolving 8.3 grams of sodium azide into 71 milliliters of water, and dissolve 21 grams of lead-II-acetate into 179 milliliters of water. Then quickly place each solution into a freezer and chill to about 5 Celsius. Thereafter, place the sodium azide into an ice bath, and then rapidly add the lead-II-acetate solution. Upon mixing, the LZ will instantaneously precipitate. After mixing both solutions, carefully filter-off the precipitated product, carefully wash with 100-milliliters of ice-cold water, and then dry in a desiccator filled with anhydrous magnesium sulfate. Do not vacuum dry or air-dry. The dry product should never be kept dry. For storage, keep the dry LZ suspended in a water free solvent such as kerosene. The product can be stored wet with water for short periods of time.

Notes:

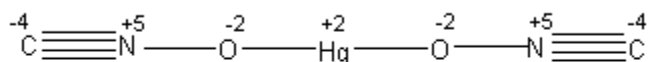
4-06. Mercury fulminate

Mercury fulminate

Mercury fulminate forms white to slightly grayish-white or slightly yellowish crystals. It is a dangerous substance and is very sensitive to shock, heat, and friction. The salt is easily detonated by shock, and reports of single drops of water impacting the surface of a single crystal have caused explosions. As a result, the compound should be gently filtered from the reaction mixture, and should be prepared in very small quantities. Mercury fulminate should be stored submerged in a water free solvent such as kerosene. Note: The above structure is isomeric to mercury cyanate, and several structures for mercury fulminate have been proposed. Mercury fulminate should be immediately de-sensitized after preparation by admixture with chalk, gum Arabic, paraffin wax, or tri sodium phosphate.

Molecular weight: 284.624	Flammability: Explodes when ignited
Detonating velocity: 3920	Toxicity: High
Sensitivity: Easily detonated	Classification: Primary explosive
Stability: Low	Overall value (as primary explosive): Moderate

Procedure 4-06A: Preparation of Mercury fulminate

Materials:	1. 200 milliliters of 70% nitric acid
	2. 20 grams mercury
	3. 240 grams 95% ethanol

Summary: Mercury fulminate is simply prepared by dissolving mercury into concentrated nitric acid, and then adding 95% ethanol at 78 Celsius. After the addition, the mixture is cooled to room temperature, and the reaction mixture poured into ice water. The mercury fulminate is then filtered-off, washed, and dried. Note: Mercury fulminate precipitates during and after the addition of the alcohol.

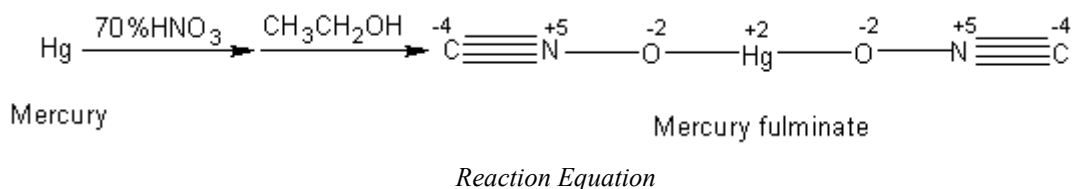

Hazards: Wear gloves and use care when handling mercury. Although mild skin contact with mercury is virtually non-toxic, inhalation of vapors may be fatal. Ingestion or skin absorption of mercury compounds can lead to illness and death. Use caution.

Procedure: Place 200 milliliters of 70% nitric acid into a beaker, and then add 20 grams of mercury. Then rapidly stir this mixture at room temperature for 24 hours. Thereafter, slowly heat the mixture to about 78 Celsius with rapid stirring, and then carefully add 240 grams of 95% ethanol while stirring the reaction mixture. After the addition of the alcohol, remove the heat source, and allow the reaction mixture to cool to room temperature. Afterwards, continue to stir the reaction mixture for about 30 minutes at room temperature. Then, filter-off the precipitated mercury fulminate, wash with several hundred milliliters of cold water, and then dry in a desiccator filled with anhydrous magnesium sulfate.

Notes:

Mercury fulminate priming mixture for rifle bullets

Into a porcelain crucible, place 40 grams of sulfur, and then 60 grams of tin. Thereafter, melt these ingredients together, and upon melting, thoroughly mix. Afterwards, stop heating and allow this tin/sulfur mixture to cool, where upon, grind it up into a fine powder. Then place 3 grams of this tin/sulfur powder mixture into a clean beaker, and then add 30 grams of freshly prepared moist mercury fulminate, then 6 grams of powdered dry flour, and then 2 grams of powdered charcoal. Then carefully blend this mixture thoroughly using a wooden spoon. After thoroughly blending, prepare a gum mixture by blending 2 grams of gum Arabic with 200 milliliters of water, and then add just enough of this gum Arabic mixture to the well blended mercury fulminate mixture to form a mild paste, and then thoroughly blend the mixture. Thereafter, the priming mixture is ready for use. To use, place the paste into a desired primer (usually 60 to 500 milligrams per primer; depending on size), and then cure the primers for several days. To initiate the primer, a standard firing pin is used.

Mercury fulminate gunpowder

Place 1360 grams of freshly prepared wet mercury fulminate into a mixing drum. Then add 908 grams of pulverized soapstone, and thoroughly blend until a uniform mixture is obtained. During the mixing process, dissolve 142 grams of gum Arabic into enough water to dissolve it, and then thoroughly blend the gum Arabic mixture. Thereafter, add this gum Arabic mixture to the fulminate and soapstone mixture, and then thoroughly blend for several hours. Afterwards, remove the "dough" from the mixing drum, and then extrude through a strainer with multiple holes, usually 1 to 2 millimeters in diameter into strands about 5 centimeters in length. Then, cut the strands equally into small 1 to 2 millimeter granules. These granules should then be dried in a desiccator or air-dried for several days. The resulting dry granules may then be packed into cartridge casings.

Mercury fulminate rim-fire priming mixture

Into a porcelain dish, place 32 grams barium peroxide, 14 grams of stibnite (antimony sulfide), and 9 grams of TNT. Then manually blend this mixture for several hours. A mixing drum may be used, and is preferred. Thereafter, add in 6 grams of freshly prepared wet mercury fulminate, and blend the mixture for several hours to form a uniform mixture. After the blending, pack into any desired primers under pressure (about 60 milligrams per primer on average), and then cure the primers for several days under pressure.

Mercury fulminate rim-fire priming mixture

Into a porcelain dish, place 70 gram of potassium chlorate, 70 grams of freshly prepared wet mercury fulminate, 60 grams of antimony sulfide, and then 10 grams of styphnic acid. Then manual blend this mixture for several hours. A mixing drum may

be used if needed. After the blending operation, press into any desired primer casing (60 to 500 milligrams per primer depending on size), and then cure the primers at room temperature for several days.

Mercury fulminate initiating mixture

The following compound is used in place of lead styphnate, lead azide, or diazodinitrophenol in their respective places in the standard blasting cap as indicated under explosive munitions of RDX. To prepare: Simply mix 160 grams of freshly prepared wet mercury fulminate with 20 grams of potassium chlorate, and 20 grams lead tetraoxide. Thoroughly blend the mixture in a porcelain dish to form a well defined, thoroughly mixed composition. The well-blended mixture will have a distinctive red color; vide supra lead tetraoxide. Afterwards, pack the mixture into a steel tube that is the exact diameter of the desired blasting cap, and only 1/5th the total length there of (the idea here is to form a pellet of this initiating mixture, so the pellet can be placed on top of the blasting caps main charge; RDX. This eliminates the need to “press” this initiating composition into the blasting cap), and then cure for several days at room temperature. Then, remove the “pellet”, and simply slide it into your desired blasting cap.

4-07. Silver fulminate

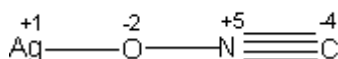

Silver fulminate

Use: Substitute for mercury fulminate.

Molecular weight: 149.885	Flammability: Explodes when heated
Detonating velocity: Similar to mercury fulminate	Toxicity: Moderate
Sensitivity: Easily detonated	Classification: Primary explosive
Stability: Low	Overall value (as primary explosive): Low

Procedure 4-07A: Preparation of Silver fulminate

Materials:	1. 100 milliliters of 70% nitric acid
	2. 16 grams silver nitrate
	3. 120 grams 95% ethanol

Summary: Silver fulminate is prepared in a similar fashion as the mercury salt; by the addition of a hot nitrate acid solution upon ethyl alcohol. In this case, silver nitrate is dissolved in nitric acid, the mixture is then heated, and the ethanol dropped in. As the reaction proceeds, the silver fulminate will precipitate. It is then easily filtered-off, washed, and dried. Note: Various modifications to this procedure exist.

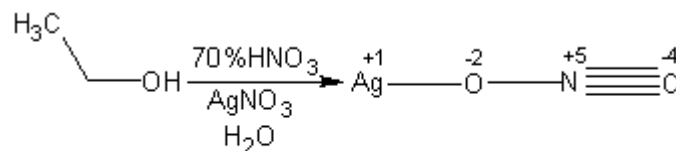

Ethyl alcohol

Silver fulminate

Reaction Equation

Hazards: Use proper ventilation when handling 95% ethyl alcohol, and avoid inhalation of vapors.

Procedure: Place 100 milliliters of 70% nitric acid into a beaker, and then add 16 grams of silver nitrate. Note: if the silver nitrate fails to dissolve, add water drop wise, until the silver nitrate dissolves. Then rapidly stir this mixture at room temperature for 24 hours. Thereafter, slowly heat the mixture to about 80 Celsius with rapid stirring, and then carefully add 120 grams of 95% ethanol while stirring the reaction mixture. After the addition of the alcohol, remove the heat source, and allow the reaction mixture to cool to room temperature. Afterwards, rapidly filter-off the precipitated silver fulminate, wash with several hundred milliliters of cold water, and then dry in a desiccator filled with anhydrous magnesium sulfate. Store the silver fulminate (submerged in kerosene) in an amber glass bottle.

Silver fulminate priming mixture for rifle bullets

This process is identical to the mercury priming mixture, except that silver fulminate is used. Into a porcelain crucible, place 40 grams of sulfur, and then 60 grams of tin. Thereafter, melt these ingredients together, and upon melting, thoroughly mix. Afterwards, stop heating and allow this tin/sulfur mixture to cool, where upon, grind it up into a fine powder. Then place 3 grams of this tin/sulfur powder mixture into a clean beaker, and then add 30 grams of freshly prepared moist silver fulminate, then 6 grams of powdered dry flour, and then 2 grams of powdered charcoal. Then carefully blend this mixture thoroughly using a wooden spoon. After thoroughly blending, prepare a gummy mixture by blending 2 gram of gum Arabic with 200 milliliters of water, and then add just enough of this gum Arabic mixture to the well blended silver fulminate mixture to form a mild paste, and then thoroughly blend the mixture. Thereafter, the priming mixture is ready for use. To use, place the paste into a desired primer, (usually 60 to 500 milligrams per primer; depending on size), and then cure the primers for several days. To initiate the primer, a standard firing pin is used.

Notes:

4-08. Copper fulminate

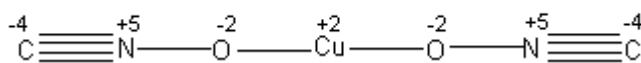

Copper fulminate

Use: Substitute for mercury fulminate.

Molecular weight: 147.584	Flammability: Explodes when ignited
Detonating velocity: Similar to mercury fulminate	Toxicity: Moderate
Sensitivity: Easily detonated	Classification: Primary explosive
Stability: Low	Overall value (as primary explosive): Low

Procedure 4-08A: Preparation of Copper fulminate

Materials:	1. 100 milliliters of 70% nitric acid
	2. 30 grams anhydrous copper-II-nitrate
	3. 120 grams 95% ethanol

Summary: Copper fulminate is prepared in a similar fashion as the mercury salt; by the addition of a hot nitrate acid solution upon ethyl alcohol. In this case, anhydrous copper nitrate is dissolved in nitric acid, the mixture is then heated, and the ethanol dropped in. As the reaction proceeds, the copper fulminate will precipitate. It is then easily filtered-off, washed, and dried.

Note: Various modifications to this procedure exist.

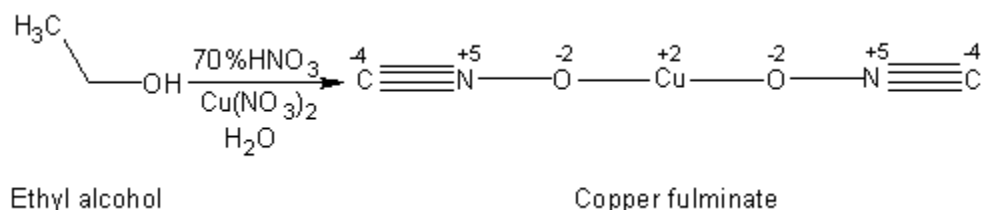

Reaction Equation

Hazards: Use proper ventilation when handling 95% ethyl alcohol, and avoid inhalation of vapors.

Procedure: Place 100 milliliters of 70% nitric acid into a beaker, and then add 30 grams of anhydrous copper-II-nitrate. Note: if the copper nitrate fails to dissolve, add water drop wise, until the copper nitrate dissolves. Then rapidly stir this mixture at

CHAPTER 4: THE PREPARATION OF METAL AZIDES, FULMINATES, AND NITRIDES

room temperature for 24 hours. Thereafter, slowly heat the mixture to about 80 Celsius with rapid stirring, and then carefully add 120 grams of 95% ethanol while stirring the reaction mixture. After the addition of the alcohol, remove the heat source, and allow the reaction mixture to cool to room temperature. Afterwards, rapidly filter-off the precipitated copper fulminate, wash with several hundred milliliters of cold water, and then dry in a desiccator filled with anhydrous magnesium sulfate. Should be stored in a desiccator over sodium sulfate in a refrigerator.

Notes:

4-09. Silver nitride

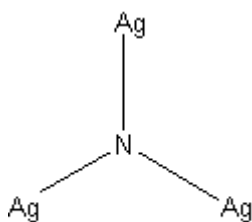

Silver nitride

Silver nitride forms a grayish powder, which rapidly darkens on standing—should be stored away from light. The salt is very explosive, and tends to decompose into silver and nitrogen on prolonged standing. Silver nitride detonates on percussion, friction, and heat—similar to the fulminate but more stable. The salt should be used immediately after preparation, and is best when desensitized with glucose, sugar, starch, wax, or gum Arabic. It is not advisable to store silver nitride by itself, and storage may be accomplished within a water inert solvent. Silver nitride can be used as a substitute for other primary explosives when it has been successfully desensitized.

Molecular weight: 337.611	Flammability: Explodes when ignited
Detonating velocity: 4000 (+ or -35)	Toxicity: Moderate
Sensitivity: Easily detonated	Classification: Primary explosive
Stability: Low	Overall value (as primary explosive): Moderate

Procedure 4-09A: Preparation of Silver nitride

Materials:	1. 20 milliliters 25% ammonia solution
	2. 10 grams of silver-I-oxide

Summary: Silver nitride is easily prepared by reacting silver-I-oxide with a concentrated ammonia solution. The mixture is then allowed to stand for 20 hours in the absence of light. During the 20-hour period, crystals of the nitride slowly precipitate. The crystals are then filtered-off, washed, and then dried.

Hazards: Use proper ventilation when handling 25% ammonia solution. Avoid inhalation of the vapors.

Procedure: Place 20 milliliters of 25% ammonia solution into a flask, and then rapidly add 10 grams of silver-I-oxide. Thereafter, allow the mixture to stand in the dark for 20 hours at room temperature. After 20 hours, filter-off the precipitated crystals of silver nitride, wash with 100 milliliters of cold water, and then dry in a desiccator over anhydrous magnesium sulfate. Once the nitride is dry, immediately use for making priming mixtures.

Notes:

4-10. Mercury nitride

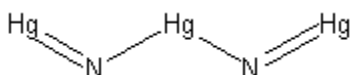

Mercury nitride

Mercury nitride forms a chocolate colored powder, which is slowly decomposed by water. The dry nitride tarnishes in air, and is slowly decomposed in acidic media. The nitride is very explosive, and must be handled with extreme care. It detonates violently yielding a white flame with a bluish purple border, and also when heated. The salt can be detonated by rubbing it with a rounded glass stir rod—very friction sensitive. Mercury nitride also easily detonates by shock, or percussion. Handle with care; never store dry; keep submerged in a water free solvent such as kerosene in amber glass bottles in a cool place. It is advisable to desensitize mercury nitride with gum Arabic, paraffin wax, or starch immediately after preparation, and these mixtures should be carefully blended using a wood spoon or plastic spatula—metal and glass should be avoided.

Molecular weight: 629.784	Flammability: Explodes when ignited
Detonating velocity: Not calculated	Toxicity: Very high
Sensitivity: Easily detonated	Classification: Primary explosive
Stability: Very low	Overall value (as primary explosive): Low

Procedure 4-10A: Preparation of Mercury nitride

Materials:	1. 10 grams of freshly prepared mercury-II-oxide
	2. 2 grams dry ammonia gas
	3. 100 milliliters of 20% nitric acid

Summary: Mercury nitride is prepared by passing ammonia over mercury oxide. The reaction is first carried out in the cold, and the temperature then raised to about 150 Celsius for the duration of the reaction. After the reaction, the contents are cooled, and then digested in dilute nitric acid to dissolve the by-product mercury formed in the reaction. The insoluble product is then simply filtered-off, washed, and dried.

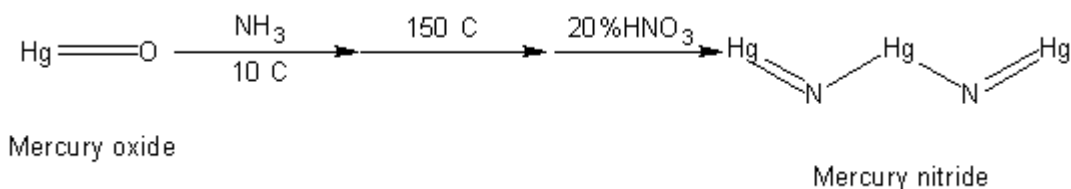

Reaction Equation

Hazards: Place the test tube behind a blast shield during the reaction for safety. Use proper ventilation when handling ammonia, and avoid inhalation of the fumes. Be aware of potential formation of mercury vapor, and use great care. As with any chemical reaction, pay attention and stay focused on what is going on, and what you are doing.

Procedure: Into a suitable test tube, fitted with a gas inlet tube, and gas outlet tube, the latter connected to a drying tube filled with anhydrous magnesium sulfate, place 10 grams of finely divided dry freshly prepared yellow mercury-II-oxide. Then, place this test tube into an ice bath and chill to 10 Celsius. Note: The test tube should be laid almost horizontally to increase the mercury oxides contact surface area, and the gas inlet tube should be extended all the way to the end of the inner test tube; the gas outlet tube should be inserted only slightly beyond the inner two-hole Teflon stopper. Thereafter, pass over the surface of the spread out mercury oxide, 600 milligrams of dry ammonia gas while keeping the mercury oxide at 10 Celsius. Afterwards, remove the ice bath, and quickly warm the test tube to room temperature. Thereafter, heat the test tube (use a Bunsen burner with a wide horizontal flame; using a elongated nozzle) to 150 Celsius, and then pass 1.4 grams of dry ammonia over the surface of the spread-out mercury oxide. After the addition the ammonia gas, remove the heat source and allow the test tube and its contents to cool to room temperature. During this cool-down period, place 100 milliliters of 20% nitric acid into a beaker, and then add all the contents in the test tube to the nitric acid all at once, and then stir for several hours to dissolve the mercury. After which, filter-off the insoluble nitride, wash rapidly with 100 milliliters of ice cold water, and then vacuum dry or air dry the product.

Notes:

4-11. Sulfur Nitride

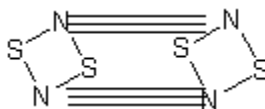

Sulfur nitride

Nitrogen tetrasulfide forms golden-yellow, yellowish red, or orange-red, transparent prismatic crystals or orange-red needles. The crystals explode when struck with a hammer or other relative object—the crystals are also quite friction sensitive. The crystals deflagrate without detonation when placed upon a hot surface, but they explode when heated to 207 Celsius. The crystals may explode when heated to 160 Celsius, producing a feeble flash of light. Sulfur nitride is capable of self-deflagration. Sulfur nitride has many potential uses in fireworks, matches, pyrotechnic compositions, and blasting caps. Sulfur nitride can be used as a substitute for diazodinitrophenol. The compound can be desensitized with clay, chalk, gypsum, or baking soda.

Molecular weight: 184.268	Flammability: Highly flammable
Detonating velocity: Not calculated	Toxicity: Low
Sensitivity: Easily detonated	Classification: Primary explosive
Stability: Moderately low	Overall value (as primary explosive): High

Procedure 4-11A: Preparation of Sulfur nitride

Materials:	1. 280 grams of benzene or 300 grams of toluene
	2. 50 grams of sulfur chloride
	3. 17 grams anhydrous ammonia gas

Summary: Sulfur nitride is conveniently prepared by passing dry anhydrous ammonia gas into a benzene or toluene solution of sulfur chloride. During the reaction, ammonium chloride and sulfur precipitates, and towards the end of the reaction, red fumes will develop. When red fumes evolve, the reaction is complete. Thereafter, the reaction mixture is filtered, and then evaporated to yield dry crystals. These crystals are then recrystallized from toluene to yield high purity sulfur nitride.

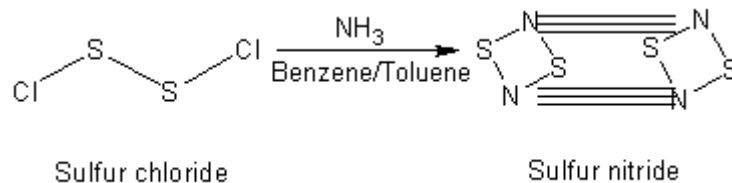

Reaction Equation

Hazards: Use proper ventilation when handling benzene or toluene. Benzene is a known carcinogen, and should be handled with care. Sulfur chloride is irritating to the eyes, nose, and throat. Use proper ventilation when handling. Sulfur chloride may also be corrosive to tissue, so wear gloves when handling. Use proper ventilation when handling ammonia, and avoid inhalation of the vapors.

Procedure: Into a suitable flask, place 280 grams of benzene, or 300 grams of toluene. Thereafter, add and dissolve 50 grams of sulfur chloride. Then, place the mixture into an ice/salt bath, and chill to -10 Celsius or less. Afterwards, bubble 17 grams of dry anhydrous ammonia gas into the mixture while rapidly stirring the reaction mixture. The rate of addition should be sufficient as to keep the reaction mixture below 0 Celsius at all times. Near the completion of the reaction, red fumes should develop. If they don't, pass some more dry ammonia (1 to 2 grams) into the reaction mixture while stirring. After the addition, remove the cooling bath, and allow the reaction mixture to warm to room temperature. Thereafter, filter-off the insoluble ammonium chloride and sulfur, and then place the filtered reaction mixture into a rotary evaporator, and remove the solvent under vacuum until dry crystals remain. If a rotary evaporator is unavailable, the reaction mixture should be placed onto a shallow pan, and allowed to air evaporate; no heat. In this case, cheaper toluene should be used; for as the solvent will be

CHAPTER 4: THE PREPARATION OF METAL AZIDES, FULMINATES, AND NITRIDES

evaporated into the air, and unrecoverable. The dry crystals should then be recrystallized from 300 grams of toluene. After collecting the crystals, dry the crystals in a desiccator within a refrigerator.

Notes:

Procedure 4-11B: Preparation of Sulfur nitride

Materials:	1. 300 grams of toluene
	2. 24 grams powdered sulfur
	3. 22 grams anhydrous ammonia gas
	4. 24 grams sulfur
	5. 26 grams dry chlorine

Summary: Sulfur nitride is conveniently prepared by passing dry anhydrous ammonia gas into a toluene solution of sulfur chloride. In this process, the sulfur chloride is prepared directly by passing dry chlorine into a suspension of powdered sulfur in toluene. Thereafter, this sulfur chloride mixture, which also contains quantities of sulfur dichloride, and tetrachloride is treated with dry ammonia gas. During the reaction, ammonium chloride and sulfur precipitates, and towards the end of the reaction, red fumes will develop. When red fumes evolve, the reaction is complete. Thereafter, the reaction mixture is filtered, and then evaporated to yield dry crystals. These crystals are then recrystallized from toluene to yield high purity sulfur nitride.

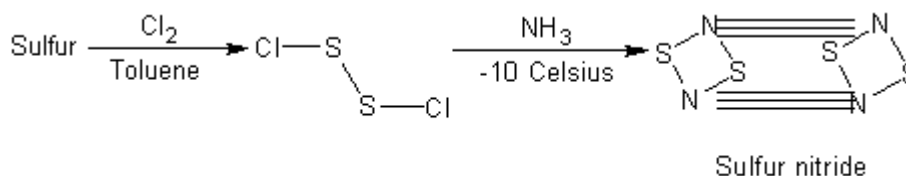

Reaction Equation

Hazards: Use proper ventilation when handling chlorine gas, and avoid inhalation of vapors. Use proper ventilation when handling toluene. Sulfur chloride is irritating to the eyes, nose, and throat. Use proper ventilation when handling. Sulfur chloride may also be corrosive to tissue, so wear gloves when handling. Use proper ventilation when handling ammonia, and avoid inhalation of the vapors.

Procedure: Into an appropriate flask, place 300 grams of dry toluene, and then add in 24 grams of powdered sulfur. Thereafter, place the flask into a cold-water bath, and then pass 26 grams of dry chlorine gas into the mixture over a several hour period while rapidly stirring the reaction mixture. During the addition, keep the toluene mixture around 10 Celsius. After the addition of the chlorine gas, filter the reaction mixture to remove any insoluble materials. Note: During the filtering process, make sure no water is present. After the filtration process, place the flask into an ice/salt bath, and chill to -10 Celsius or less. Afterwards, bubble 17 grams of dry anhydrous ammonia gas into the mixture while rapidly stirring the reaction mixture. The rate of addition should be sufficient as to keep the reaction mixture below 0 Celsius at all times. Near the completion of the reaction, red fumes should develop. If they don't, pass some more dry ammonia (1 to 2 grams) into the reaction mixture while stirring. After the addition, remove the cooling bath, and allow the reaction mixture to warm to room temperature. Thereafter, filter-off the insoluble ammonium chloride and sulfur, and then place the filtered reaction mixture into a rotary evaporator, and remove the solvent under vacuum until dry crystals remain. If a rotary evaporator is unavailable, the reaction mixture should be placed onto a shallow pan, and allowed to air evaporate; no heat. The dry crystals should then be recrystallized from 300 grams of toluene. After collecting the crystals, dry the crystals in a desiccator within a refrigerator.

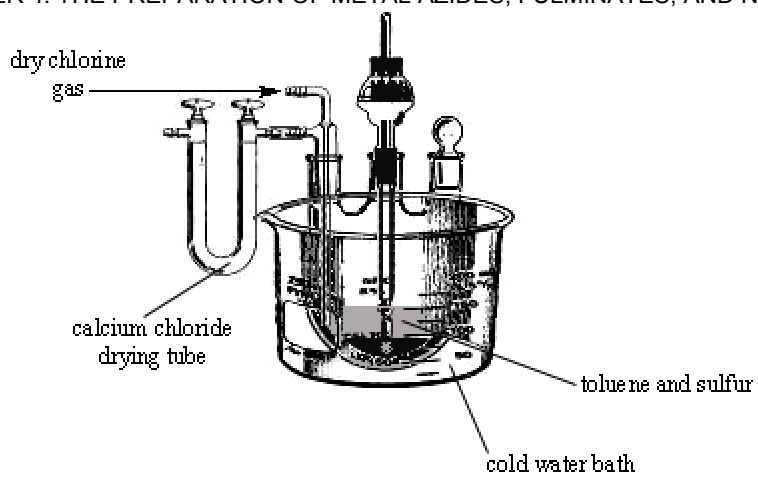

Figure 035. Apparatus for the preparation of sulfur chloride

Notes:

CHAPTER 5: THE PREPARATION OF AZIDES AND AZO NITROS

BDPF, TETRAAZIDE, TAEN, AZIDOETHYL, DANP, DIANP, DIAZODINITROPHENOL, HNTCAB, DNAT, ADN, ADBN

5-01. BDPF. *Bis(1,3-diazido-2-propyl)formal*

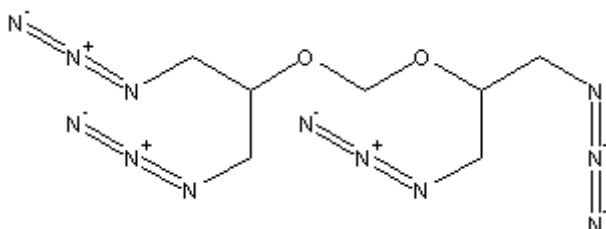

BDPF

BDPF is a colorless or slightly yellow, oily liquid with a freezing point of -22 Celsius. It is an excellent plasticizer for solid rocket propellants, high performance gun propellants, and explosive formulations. BDPF may be used in the preparation of flexible sheet explosives, plastic explosives, and other moldable or flexible formulations. BDPF has excellent properties and stability, but can detonate on shock or percussion.

Molecular weight: 296.250	Flammability: Generally considered non flammable
Detonating velocity: Not calculated	Toxicity: Moderate
Sensitivity: Detonates rather easily	Classification: A primary explosive
Stability: Good	Overall value (as primary explosive): High

Procedure 5-01A: Preparation of BDPF

Materials:	1. 103.2 grams 1,3-dichloro-2-propanol
	2. 12 grams trioxane (as formaldehyde)
	3. 500 milliliters of 1,2-dichloroethane
	4. 59.6 grams 98% sulfuric acid
	5. 600 milliliters of 1% baking soda solution
	6. 200 milliliters of dimethylsulfoxide
	7. 10.1 grams sodium azide
	8. 550 milliliters methylene chloride
	9. 100 grams of anhydrous magnesium sulfate

Summary: BDPF is prepared in a two-step process starting with the formation of the intermediate, bis(1,3-dichloro-2-propanol). This intermediate is prepared by the reaction between 1,3-dichloro-2-propanol and trioxane in 1,2-dichloroethane. Concentrated sulfuric acid is then added, and the resulting mixture stirred for a period of time. The mixture is then allowed to stand, and the upper 1,2-dichloroethane layer is removed, and evaporated to yield the oily yellow liquid intermediate. This intermediate is then treated with sodium azide in dimethylsulfoxide with heat. The reaction mixture is then cooled to room temperature, and then extracted with methylene chloride. The methylene chloride mixture is then evaporated to yield a yellow oily liquid. Commercial & Industrial note: For related, or similar information, see Application No. 563,918, June 27th, 1990, by Aerojet General Corporation, to Renato R. Rindone, Fair Oaks, CA, Der-Shing Huang; Carmichael, CA, Edward E. Hamel, Roseville, CA. Part or parts of this laboratory process may be protected by international, and/or commercial/industrial processes. Before using this process to legally manufacture the mentioned explosive, with intent to sell, consult any protected commercial or industrial processes related to, similar to, or additional to, the process discussed in this procedure. This process may be used to legally prepare the mentioned explosive for laboratory, educational, or research purposes.

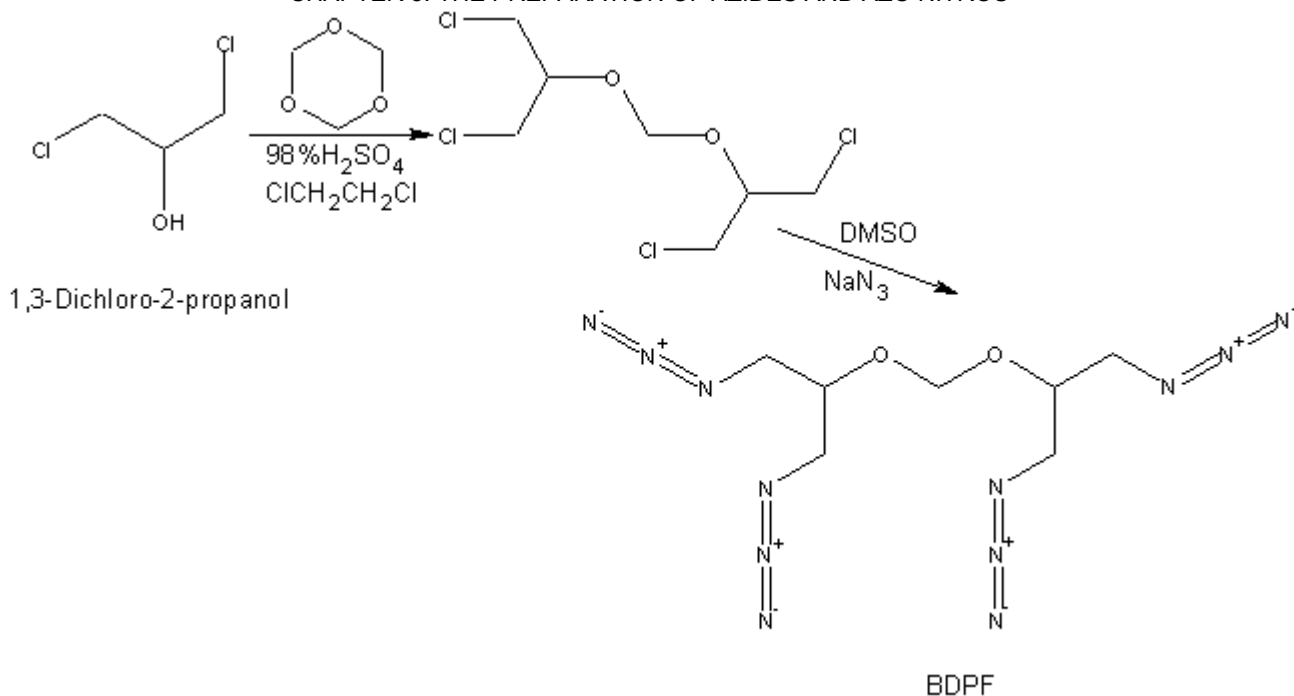
*Reaction Equation*

Hazards: Use proper ventilation and wear gloves when handling trioxane, 1,2-dichloroethane, and 1,3-dichloro-2-propanol. Avoid inhalation of vapors. Use caution and wear gloves when handling 98% sulfuric and sodium azide. Sodium azide is highly toxic, and can be absorbed through the skin.

Procedure:

Step 1: Preparation of bis(1,3-dichloro-2-propyl) Formal

Into a 3-neck flask equipped with a motorized stirrer, thermometer, and addition funnel, add 103.2 grams of 1,3-dichloro-2-propanol, then 12 grams of trioxane (as formaldehyde), and then 400 milliliters of 1,2-dichloroethane. Then, place this mixture into a cold-water bath at 15 Celsius. Thereafter, slowly add drop-wise, 59.6 grams of 98% sulfuric acid over a period of 32 minutes. During the addition, rapidly stir the 1,3-dichloro-2-propanol mixture and keep its temperature below 25 Celsius. After the addition, remove the water bath, and then stir the reaction mixture at room temperature for 5.4 hours. Thereafter, turn off the stirrer, and allow the reaction mixture to stand for several minutes. Then, drain-off the bottom acid layer, and then extract with 100 milliliters of 1,2-dichloroethane. Note: after the extraction, the 1,2-dichloroethane will be the bottom layer. After the extraction, add this 1,2-dichloroethane portion to the upper 1,2-dichloroethane layer of the reaction mixture. Then, wash this 1,2-dichloroethane with 600 milliliters of a 1% baking soda solution, followed by two 600-milliliter portions of water. Note: after each washing, the 1,2-dichloroethane will be the bottom layer each time as long as no sulfuric acid is present. After the washing, place the 1,2-dichloroethane mixture into a rotary evaporator or vacuum distillation apparatus, and remove the 1,2-dichloroethane under vacuum until no more 1,2-dichloroethane remains. The result will be 86.64 grams of an oily yellow liquid, which will solidify to a slushy consistency upon standing at room temperate.

Step 2: Preparation of bis(1,3-diazido-2-propyl) Formal (BDPF)

Into a 3-neck flask equipped with a motorized stirrer, thermometer, and addition funnel, add 150 milliliters of dimethylsulfoxide. Then heat this to 75 Celsius. There upon, add in one portion, 10.1 grams of sodium azide. During the addition, rapidly stir the sulfuric acid. After the addition, raise the temperature to 95 Celsius. Thereafter, add and dissolve 10 grams of the oily liquid (obtained in step 1) into 25 milliliters of dimethylsulfoxide, and then add drop-wise, this solution to the sulfuric acid/azide mixture over a period of 64 minutes, while rapidly stirring the sulfuric acid/azide mixture. After the addition, continue to stir the reaction mixture at 95 Celsius for 4 hours. After which, remove the heat source, and allow the reaction mixture to cool to room temperature. Then, add 400 milliliters of water to the reaction mixture and stir for several minutes. Thereafter, extract the reaction mixture with two 200-milliliter portions of methylene chloride. Note: after each extraction, the methylene chloride will be the bottom layer. After the extraction, combine all methylene chloride portions, if not already done so, and then wash with two 400-milliliter portions of cold water. Note: After each washing, the methylene chloride will be the bottom layer. After the washings, dry the methylene chloride over 100 grams of anhydrous magnesium

CHAPTER 5: THE PREPARATION OF AZIDES AND AZO NITROS

sulfate while stirring for several minutes. After which, filter-off the magnesium sulfate, and then place the filtered methylene chloride mixture into a rotary evaporator, and remove the methylene chloride under vacuum until no more methylene chloride remains. If a rotary evaporator is unavailable, place the methylene chloride mixture into a distillation apparatus, and remove the methylene chloride by careful distillation. When the methylene chloride has been completely removed, remove the oily yellow liquid, and place into an amber glass bottle in a refrigerator until use. Note: For ultra pure liquid, the yellow oily liquid product may be purified by passing through a silica gel column filled with silica gel or alumina, followed by three portions of 50-milliliters each of methylene chloride. The collected liquids are then evaporated to remove the methylene chloride, and leave the colorless oily liquid product behind. The result will be about 10 grams of desired liquid product. Note: for use in explosives compositions, and rockets propellants, the yellow liquid product need not be purified.

Notes:

5-02. TETRAZIDE. *Isocyanogen tetraazide*

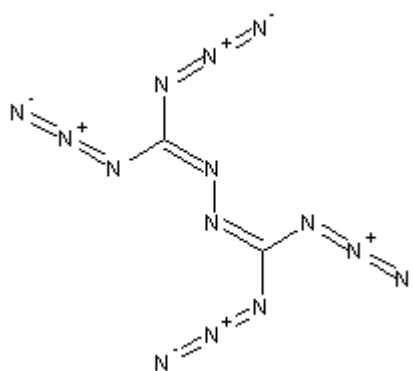

TETRAAZIDE

TETRAAZIDE forms crystalline colorless needles with a melting point of 89 Celsius without decomposition. Small amounts of TETRAAZIDE will volatilize when slowly heated to 150 Celsius, but if it is rapidly heated, it explodes violently. TETRAAZIDE is shock sensitive, and easily explodes when struck, or brushed hard. It is soluble in alcohol, ether, acetone, xylene, and methylene chloride. TETRAAZIDE is an interesting explosive with massive 89% nitrogen content, making it a very high-energy substance. TETRAAZIDE may be used in blasting caps, or detonators in place of diazodinitrophenol, lead azide, or other primary explosives. TETRAAZIDE may also be used in explosives compositions for boosters of the tetryl type.

Molecular weight: 220.12	Flammability: Explodes when ignited
Detonating velocity: Not calculated	Toxicity: Moderate
Sensitivity: Detonates rather easily	Classification: A primary explosive
Stability: Moderate	Overall value (as primary explosive): Moderate

Procedure 5-02A: Preparation of TETRAAZIDE

Materials:	1. 20 grams isocyanogen tetrabromide
	2. 200 milliliters acetone
	3. 18 grams sodium azide

Summary: TETRAAZIDE is prepared by reacting isocyanogen tetrabromide with sodium azide in the presence of acetone. The resulting product is then crystallized out of solution by allowing it to stand with ice water. The product is then filtered-off, washed, and then dried. The isocyanogen tetrabromide should be sublimed before use; in order to ensure purity because the tetrabromide may break down into unwanted products on standing over time. Never use isocyanogen tetrabromide that has been standing for some time. Commercial & Industrial note: For related, or similar information, see Serial No. 806,210, April 14th, 1959, by Olin Mathieson Chemical Corporation, to Christoph J. Grundmann, Lancaster PA, and Wilhelm Joseph Schnabel, Columbus, OH. Part or parts of this laboratory process may be protected by international, and/or commercial/industrial processes. Before using this process to legally manufacture the mentioned explosive, with intent to sell,

CHAPTER 5: THE PREPARATION OF AZIDES AND AZO NITROS

consult any protected commercial or industrial processes related to, similar to, or additional to, the process discussed in this procedure. This process may be used to legally prepare the mentioned explosive for laboratory, educational, or research purposes.

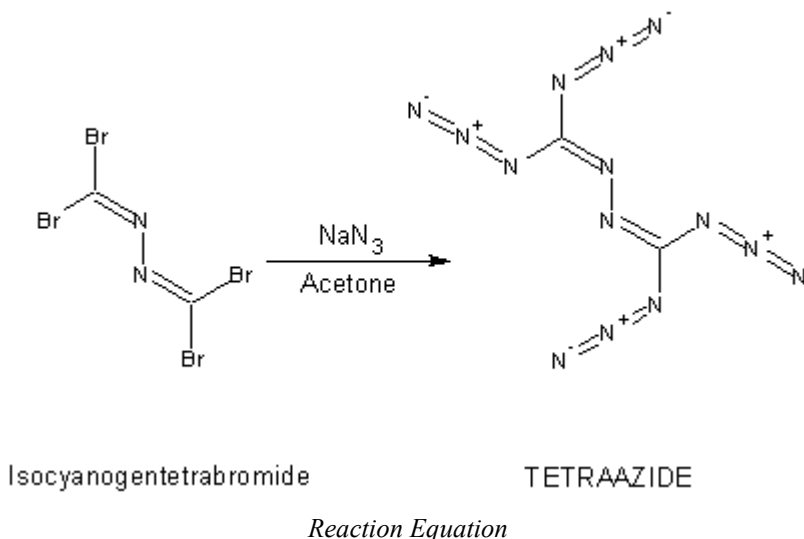

Hazards: Use proper ventilation when handling acetone, and extinguish all flames before use. Avoid inhalation of vapors

Procedure: Dissolve 20 grams of isocyanogen tetrabromide, after being freshly sublimed, into 200 milliliters of acetone, and then cool the solution to 0 Celsius by means of an ice bath. Then dissolve 18 grams of sodium azide into 120 milliliters of water, and then cool this solution to 0 Celsius as well. Thereafter, add drop wise, the sodium azide solution to the tetrabromide solution over a period of 2 hours while rapidly stirring the tetrabromide solution, and maintaining its temperature at 0 Celsius. After the addition, remove the ice bath and then stir the mixture rapidly for 4 hours. During which time the reaction mixture will warm to about 30 Celsius. Then pour the entire reaction mixture into 750 milliliters of ice water, and then place this mixture into an ice bath at 0 Celsius. Shortly afterward, rapidly stir the mixture for 1 hour. After which, filter-off the precipitated crystals, wash with 750 milliliters of ice water, and then air-dry the product. The result will be 9 grams of product in the form of colorless, needle shaped crystals.

Notes:

5-03. TAEN. *Triazoethanol nitrate*

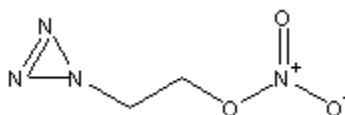

TAEN

TAEN is a colorless, oily, mobile, non-acidic liquid. It is a powerful explosive with superior properties to nitroglycerine because it contains a nitro group, and an azido group. It has greater resistance to shock and percussion than nitroglycerine and is more powerful than nitroglycerine. Its chief use is in making nitroglycerine free dynamites—does not cause headache on exposure, and has greater stability in cold environments.

Molecular weight: 128.047	Flammability: Generally considered non flammable
Detonating velocity: Similar to nitroglycerine	Toxicity: Moderate
Sensitivity: Low	Classification: Secondary explosive
Stability: Good	Overall value (as secondary explosive): Very high

Procedure 5-03A: Preparation of TAEN

Materials:	1. 16 grams 99% nitric acid
	2. 24 grams 98% sulfuric acid
	3. 20 grams of triazoethanol
	4. 300 milliliters 10% baking soda solution
	5. 40 grams anhydrous sodium sulfate

Summary: TAEN is prepared by reacting triazoethanol with a nitrating acid mixture. During the formation of the TAEN, the liquid product will condense forming an upper liquid layer. After the reaction, this upper layer is simply decanted, washed, and then dried over anhydrous sodium sulfate. Commercial & Industrial note: For related, or similar information, see Serial No. 116,977, June 18th, 1926, by E.I. Dupont de Nemours & Company, to Frank H. Bergeim. Part or parts of this laboratory process may be protected by international, and/or commercial/industrial processes. Before using this process to legally manufacture the mentioned explosive, with intent to sell, consult any protected commercial or industrial processes related to, similar to, or additional to, the process discussed in this procedure. This process may be used to legally prepare the mentioned explosive for laboratory, educational, or research purposes.

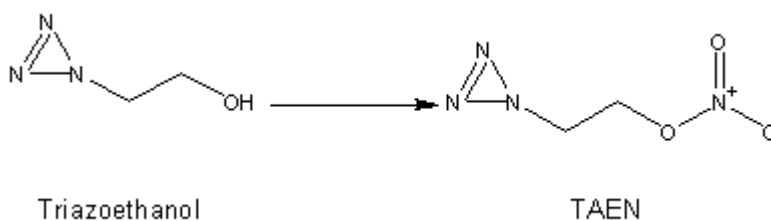
*Reaction Equation*

Hazards: Wear gloves and use proper ventilation when handling 99% nitric acid. The acid is highly corrosive, and toxic emitting poisonous fumes of nitrogen oxides; use great care. Wear gloves and proper lab clothing when handling 98% sulfuric acid.

Procedure: Prepare a nitrating acid mixture by adding 16 grams of 99% nitric acid into a flask, and then add 24 grams of 98% sulfuric acid. Thereafter, chill this acid mixture to 0 Celsius by means of an ice bath. After which, gradually add 20 grams of triazoethanol over a sufficient period as to keep the nitrating acid temperature at 0 Celsius. During the addition, stir the nitrating acid mixture rapidly. After the addition, stir for about 20 minutes at 0 Celsius, and then decant the upper TAEN liquid layer, and then wash this layer with three 100 milliliter portions of 10% baking soda solution. Note: during the addition, the TAEN will be the upper layer if sulfuric acid be present. If sulfuric acid is not present, it will be the bottom layer. After the washings, dry the liquid product over 40 grams of anhydrous sodium sulfate with stirring for several minutes, and then filter-off the sodium sulfate. The result will be a clear, oily liquid.

Notes:

A TAEN containing dynamite

Into a beaker place 24 grams of wood meal, and then 2 grams of chalk. Thereafter, begin rapidly blending, and during which time, slowly add 30 grams of nitroglycerine, and then slowly add 30 grams of TAEN. After which, slowly add 114 grams of sodium nitrate while rapidly blending the mixture. After the addition of the sodium nitrate, continue to rapidly blend the mixture for several hours at room temperature to ensure a well mixed explosive. After blending for several hours, transfer the mixture into any suitable container, such as, cardboard tubes, steel tubes, plastic tubes, or plastic containers of any desired shape and/or size. For demolition purposes, cardboard or plastic tubes, 2 inches by 6 inches are preferred. For use in warfare, steel pipes 1 inch by 6 inches can be used to produce a casualty radius of 15 meters. A blasting cap or detonator is required for initiation.

5-04. AZIDOETHYL. *Tris(2-azidoethyl)amine*

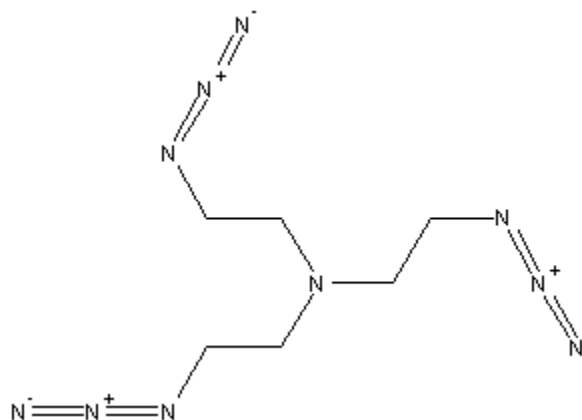

AZIDOETHYL

Uses: Has limited use due its manufacturing process, but may show increased use when better methods of preparation are developed. It can be used with satisfaction in military smokeless powders, and smokeless rocket propellants.

Molecular weight: 224.227	Flammability: Generally considered non flammable
Detonating velocity: Similar to BDPF	Toxicity: Moderate
Sensitivity: Moderate	Classification: Primary explosive
Stability: Good	Overall value (as primary explosive): High

Procedure 5-04A: Preparation of AZIDOETHYL

Materials:	1. 200 milliliters dimethylformamide
	2. 74 grams sodium azide
	3. 70 grams 2,2',2''-trichloroethylamine
	4. 360 milliliters chloroform
	5. 100 grams anhydrous sodium sulfate

Summary: AZIDOETHYL is prepared by the reaction between 2,2',2''-trichloroethylamine and sodium azide. The resulting mixture is then treated with chloroform, and the layer removed. Thereafter, the chloroform is removed under vacuum.

Commercial & Industrial note: For related, or similar information, see Application No. 401,476, July 26, 1982, by Rockwell International Corporation, to Milton B. Frankel, Tarzana, CA, and Edgar R. Wilson, Simi Valley, CA. Part or parts of this laboratory process may be protected by international, and/or commercial/industrial processes. Before using this process to legally manufacture the mentioned explosive, with intent to sell, consult any protected commercial or industrial processes related to, similar to, or additional to, the process discussed in this procedure. This process may be used to legally prepare the mentioned explosive for laboratory, educational, or research purposes.

Hazards: This procedure should be handled with extreme caution, although AZIDOETHYL is relatively harmless, 2,2',2''-trichloroethylamine is a blister agent, and an active chemical warfare agent. 2,2',2''-trichloroethylamine is a chemical agent of the nitrogen mustard category (HN3), with toxic effects similar to, but more severe than mustard gas (see The Preparatory Manual of Chemical Warfare agents for more info). Use a "clean" fume hood when handling. A "clean" fume hood is a fume hood that is completely sealed from the atmosphere. Avoid inhalation or skin absorption. Contamination of the skin should be immediately washed with large amounts of hot soapy water. Inhalation of vapors may cause painful death. Avoid skin contact and ingestion of sodium azide. Sodium azide is very poisonous. Use proper ventilation when handling chloroform, and avoid inhalation of vapors.

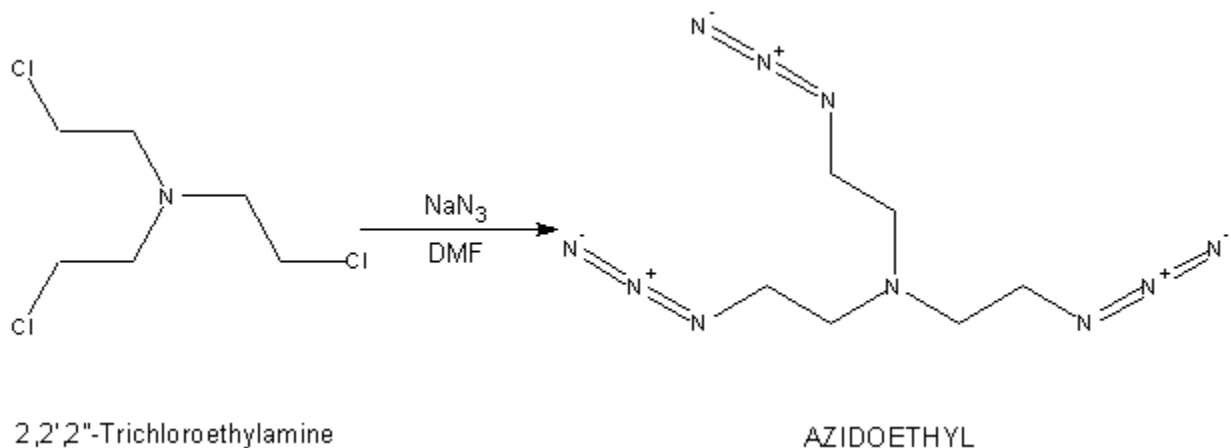
*Reaction Equation*

Procedure: Into a suitable flask place 200 milliliters of dimethylformamide, and then add and dissolve 74 grams of sodium azide. Thereafter, gradually add 70 grams of 2,2',2''-trichloroethylamine, while rapidly stirring the sodium azide solution. After the addition, reflux the mixture at 95 Celsius while stirring for 3 hours. After heating for 3 hours, remove the heat source and allow the reaction mixture to cool to room temperature. Thereafter, drown the reaction mixture into 1 liter of cold water while rapidly stirring the cold water. After adding the reaction mixture to the water, add 200 milliliters of chloroform with rapid stirring. Then stir the mixture for about 20 minutes. Then, remove the bottom chloroform layer, and the wash with six 200-milliliter portions of cold water. Note: after each washing, the chloroform will be the bottom layer. After the washings, add 100 grams of anhydrous sodium sulfate to absorb moisture, and then filter-off the sodium sulfate after stirring in the chloroform for several minutes. Thereafter, pass this chloroform mixture through a silica gel column filled with alumina, followed by three portions of 40 milliliters of chloroform. Then, place the collected chloroform mixture into a rotary evaporator, and evaporate-off the chloroform under vacuum until a pale yellow oil remains. Thereafter, remove the pale yellow oil, and store in a suitable amber glass bottle in a refrigerator until use. The result will be 64 grams of a liquid product with a purity of 98%+.

Notes:

5-05. DANP. 1,3-Diazido-2-nitrazapropane

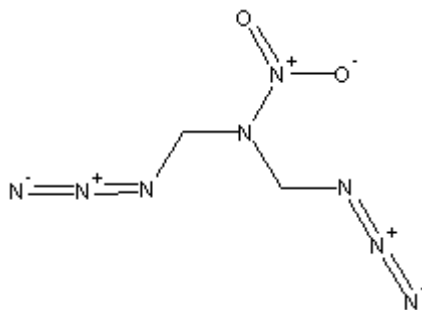

DANP

DANP is a colorless, or yellow, oily liquid. It can be distilled under reduced pressure (vacuum distillation). It is an excellent high-energy plasticizer for use in making flexible sheet explosives when mixed with RDX, TNT, or HMX. It can also be used in place of nitroglycerine for dynamites, rocket propellants, gun propellants, and explosive compositions.

Molecular weight: 168.076	Flammability: Generally considered non flammable
Detonating velocity: Similar to TAEN	Toxicity: Moderate
Sensitivity: Low	Classification: Secondary explosive
Stability: Good	Overall value (as secondary explosive): High

Procedure 5-05A: Preparation of DANP

Materials:	1. 7680 milliliters acetic anhydride
	2. 2880 milliliters 99% nitric acid
	3. 1898 grams hexamine
	4. 3520 milliliters of glacial acetic acid
	5. 5000 milliliters methylene chloride
	6. 1000 milliliters 10% baking soda solution
	7. 200 grams anhydrous magnesium sulfate
	8. 800 milliliters dioxane
	9. 168 grams anhydrous hydrogen chloride
	10. 1000 milliliters acetone
	11. 390 grams sodium azide

Summary: DANP is prepared in a three-step process starting with the formation of 1,3-diacetoxy-2-nitrazapropane. This intermediate is prepared by treating acetic anhydride with a solution of hexamine and glacial acetic acid with 99% nitric acid. The resulting intermediate is then recovered by vacuum distillation. This compound is then converted to 1,3-dichloro-2-nitrazapropane by adding anhydrous hydrogen chloride. Once again, the chlorinated intermediate is recovered by vacuum distillation. The chlorinated compound is then covered into DANP by reaction with sodium azide. The resulting mixture is then extracted, and the methylene chloride removed. The resulting yellow oil is suitable for use in explosives, but can be purified by vacuum distillation if desired. Commercial & Industrial note: For related, or similar information, see Application No. 734,495, October 21, 1976, by Rockwell International Corporation, to Milton B. Frankel, Tarzana, CA, Joseph E. Flanagan, Woodland Hills, CA. Part or parts of this laboratory process may be protected by international, and/or commercial/industrial processes. Before using this process to legally manufacture the mentioned explosive, with intent to sell, consult any protected commercial or industrial processes related to, similar to, or additional to, the process discussed in this procedure. This process may be used to legally prepare the mentioned explosive for laboratory, educational, or research purposes.

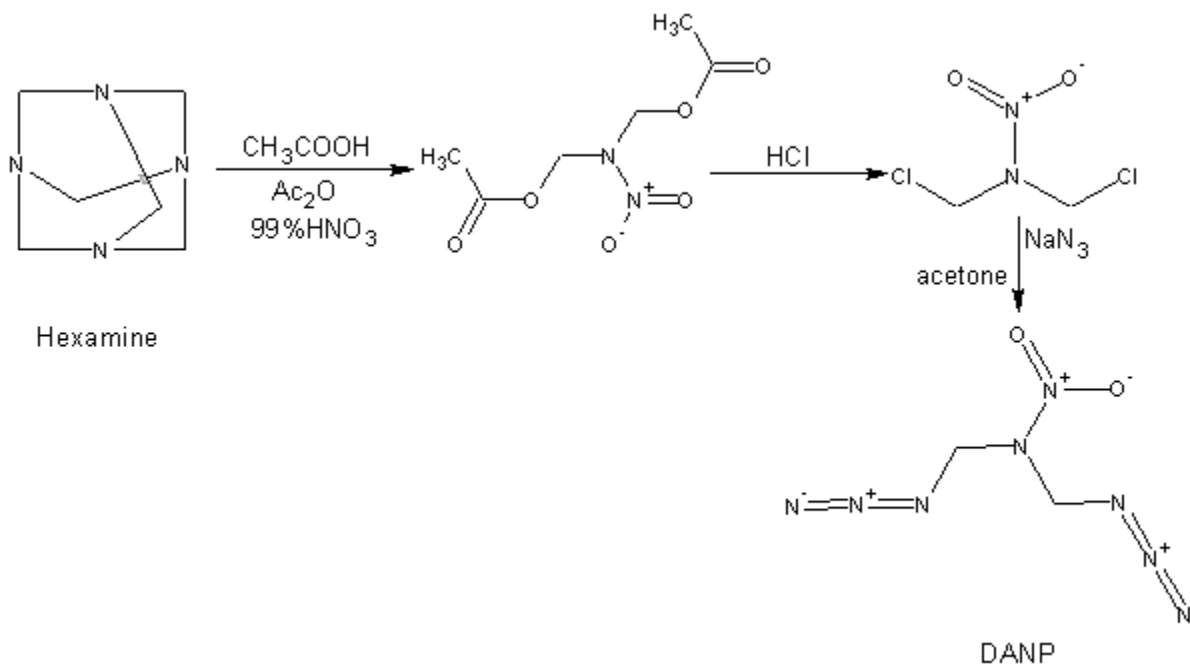
*Reaction Equation*

Hazards: Wear gloves and use maximum ventilation when handling 99% nitric acid. Avoid inhalation of the fumes. Extinguish all flames before using acetic anhydride, acetone, or dioxane, and avoid inhalation of the vapors. Use care when handling sodium azide, and avoid skin contact or ingestion. Sodium azide is very toxic. Note: Dioxane is a suspected carcinogen

Procedure: Note: This procedure uses an excessive amount of 90% nitric acid. It should be noted that this quantity of acid is necessary to carryout the reaction for the product at hand. It should be noted that other nitro compounds are produced during

CHAPTER 5: THE PREPARATION OF AZIDES AND AZO NITROS

this procedure. These compounds can be isolated using various techniques, but these techniques will not be discussed here as they deviate from the procedure.

Step 1: Preparation of 1,3-diacetoxy-2-nitrazapropane

Into a large 3-neck flask equipped with a motorized stirrer, and thermometer, add 7680 milliliters of acetic anhydride, and then cool the flask in an ice bath to 0 Celsius. Then, slowly add 2880 milliliters of 99% nitric acid drop wise, over a period of 1 hour while rapidly stirring the acetic anhydride and keeping its temperature below 10 Celsius. After the addition, prepare a solution by adding 1898 grams of hexamine into 3520 milliliters of glacial acetic acid. Thereafter, add this hexamine solution to the acetic anhydride/nitric acid mixture over a period of 3 hours while stirring the reaction mixture and keeping its temperature below 10 Celsius. After the addition, remove the ice bath, and allow the reaction mixture to warm to room temperature. Thereafter, allow the reaction mixture to stand for 10 hours while stirring at room temperature. After which, stop stirring and allow the reaction mixture to stand without stirring overnight. The following day, filter-off the high explosive by-product, 1,7-diacetoxy-2,4,6-trinitroazaheptane. **Note: this high explosives by-product can be washed and dried and used as a high-energy plasticizer if desired.** Then, mix the filtered reaction mixture into 3000 milliliters of methylene chloride, and then wash the mixture with 2000 milliliters of cold water, then 1000 milliliters of 10% baking soda solution, and then with 2000 milliliters of cold water. Note: after each washing, the methylene chloride will be the bottom layer. Then, add 100 grams of anhydrous magnesium sulfate, and then stir the mixture for several minutes. After which, filter-off the magnesium sulfate, and then place the filtered-off mixture into a rotary evaporator, and evaporate-off the methylene chloride under vacuum until a liquid residue oil is obtained. Note: use as little heat as possible. After the methylene chloride has been removed, place the remaining liquid residue into a vacuum distillation apparatus, and distill the mixture at 121 Celsius under high vacuum. The result will be about 664 grams of the intermediate, 1,3-diacetoxy-2-nitrazapropane.

Step 2: Preparation of 1,3-dichloro-2-nitrazapropane

Prepare a solution by dissolving 476 grams of 1,3-diacetoxy-2-nitrazapropane (prepared in step 1) into 800 milliliters of dioxane. Thereafter, pass 168 grams of anhydrous hydrogen chloride into the mixture over a period of 3 hours while rapidly stirring the reaction mixture. After the addition of the hydrogen chloride, store the reaction mixture in a refrigerator for 3 days. After 3 days, place the mixture into a rotary evaporator, and evaporate-off the dioxane under vacuum. Note: use as little heat as possible. After removing the dioxane, place the remaining oily crude residue into a vacuum distillation apparatus, and distil the mixture at 64 Celsius under vacuum. The result will be 344 grams of the product as a colorless liquid. This liquid will crystallize on standing.

Step 3: Preparation of DANP

Prepare a solution by dissolving the product obtained in step 2 into 1000 milliliters of acetone. Thereafter, prepare a second solution by dissolving 390 grams of sodium azide into 1200 milliliters of water. After which, add drop wise, the acetone solution to the sodium azide solution over a period of 1 hour while rapidly stirring the sodium azide solution and maintaining its temperature below 30 Celsius. Note: during the addition, a water bath may be needed to keep the temperature below 30 Celsius. After the addition, stir the reaction mixture for 6 hours at room temperature. Thereafter, extract the mixture with five 400-milliliter portions of methylene chloride. After the extraction process, combine all the methylene chloride layers, if not already done so, and then wash with 1000 milliliters of cold water, followed by treatment with 100 grams of anhydrous magnesium sulfate. Then, filter-off the magnesium sulfate, and then place the mixture into a rotary evaporator and evaporate-off the methylene chloride until only an oily liquid residue remains. The result will be 320 grams of a yellow oil. Then, place this yellow oil into a vacuum distillation apparatus, and distil the yellow oil at 97 Celsius under vacuum. The result will be a clear oily liquid.

Notes:

DANP used as plasticizer

Into a beaker place 240 grams of finely divided nitrocellulose, and then add 160 grams of DANP over a short time period while rapidly, but not violently stirring the mixture. After the addition, rapidly blend for several hours to form a uniform mixture free from voids, air pockets, or globules. Thereafter, the mixture can be packed into rocket motors, and cured for several days at room temperature. If propellants grains are desired, after the mixing period, extrude the mixture through an extruding machine into strands 1 to 2 millimeters thick and 10 centimeters long. Thereafter, cut the strands into pieces 1 to 2 millimeters thick.

Afterwards, cure the granules for several days at room temperature before use. After which, the granules can be packed into gun casings. Note: Do not use a blasting cap or detonator for initiations.

5-06. DIANP. *1,5-diazido-3-nitrazo pentane*

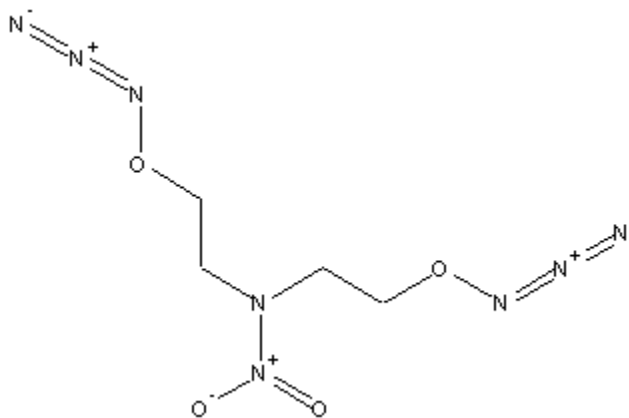

DIANP

DIANP is a colorless liquid, which is soluble in acetone, methanol, dimethylformamide, DMSO, ethyl acetate, and benzene. It is not very soluble in water, ethanol, or butanol. DIANP is used in gun propellants and rocket propellants to reduce flame temperatures, toxic combustion products, smoke, and to increase performance without sacrificing burn rate. DIANP is an excellent substitute for nitroglycerine for gun propellants and rocket propellants.

Molecular weight: 224.096	Flammability: Generally considered non flammable
Detonating velocity: Similar to DANP	Toxicity: Moderate
Sensitivity: Low	Classification: Secondary explosive
Stability: Good	Overall value (as secondary explosive): High

Procedure 5-06A: Preparation of DIANP

Materials:	1. 1000 milliliters of DMSO
	2. 162 grams sodium azide
	3. 242 gram of DINA
	4. 4100 milliliters methylene chloride
	5. 200 grams anhydrous sodium sulfate
	6. 300 grams neutral activated alumina

Summary: DIANP is prepared by reacting DINA with sodium azide in the presence of DMSO. The resulting reaction mixture is then separated into two layers. The bottom layer is removed and dissolved in methylene chloride. The top layer is extracted with methylene chloride, and all methylene chloride layers are then combined. The resulting methylene chloride mixture is passed through a glass column (silica gel column) filled with neutral activated alumina. The collected methylene chloride is then evaporated to yield the liquid product. Commercial & Industrial note: For related, or similar information, see Application No. 478,437, March 24, 1983, by Hercules Incorporated, to Ronald L. Simmons, Destin, FL, and Herbert L. Young, Shalimar, FL. Part or parts of this laboratory process may be protected by international, and/or commercial/industrial processes. Before using this process to legally manufacture the mentioned explosive, with intent to sell, consult any protected commercial or industrial processes related to, similar to, or additional to, the process discussed in this procedure. This process may be used to legally prepare the mentioned explosive for laboratory, educational, or research purposes.

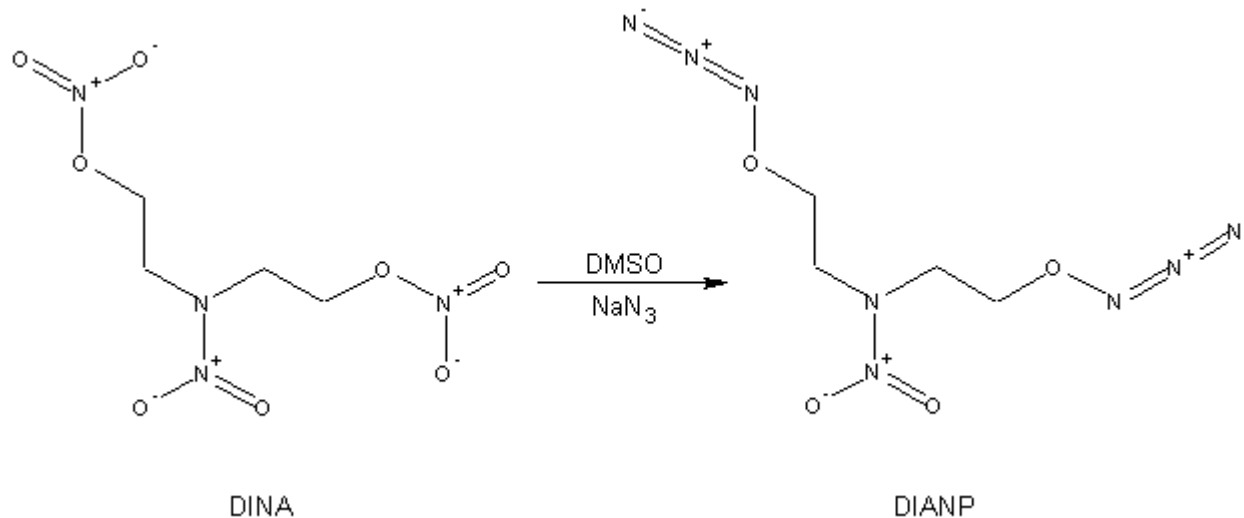
*Reaction Equation*

Hazards: Wear gloves and use proper ventilation when handling DMSO, and avoid inhalation of vapors. Wear gloves when handling sodium azide. Sodium azide is highly poisonous, and can be absorbed by the skin.

Procedure: Place 600 milliliters of DMSO into a 3-neck flask fitted with a condenser, thermometer, stirrer, and addition funnel. Then, gradually add 162 grams of sodium azide while rapidly stirring the DMSO. Note: Sodium azide is not very soluble in DMSO, so it will form a fine crystalline precipitate. After the addition, prepare a solution by adding and dissolving 242 grams of DINA into 400 milliliters DMSO, and thereafter, filter the mixture to remove any insoluble impurities. After which, heat the sodium azide/DMSO mixture to 80 Celsius. When the temperature reaches 80 Celsius, slowly add, drop wise, the DINA/DMSO mixture to the sodium azide/DMSO mixture over a period of about 4 hours while keeping the sodium azide/DMSO mixture below 85 Celsius, and stirring rapidly. After the addition, continue to stir the reaction mixture at 80 Celsius for 4 hours. After which, remove the heat source, and cool to room temperature. Then, stir the mixture for another 4 hours at room temperature. Afterwards, add 4 liters of cold water over a period of 2 hours while stirring the reaction mixture. After the addition, continue to stir the reaction mixture for 40 minutes. A two-phase system will form. The top layer is the water layer, and it will be a hazy dark orange-red. Then, decant the upper water layer, or use a separatory funnel. Then, dissolve the bottom layer into 1200 milliliters of methylene chloride. Afterwards, extract the upper water layer with four 600-milliliter portions of methylene chloride. After the extraction, combine all extractions, if not already done so, and then add them to the methylene chloride containing the bottom layer. Then, wash the methylene chloride mixture with three 600-milliliter portions of cold water. After the washing, add 200 grams of anhydrous sodium sulfate, and stir the mixture for 20 minutes. Afterwards, filter-off the sodium sulfate. Then, place 300 grams of neutral activated alumina into a beaker, and then add 100 milliliters of methylene chloride. Then stir the mixture for several minutes. Afterwards, place this activated alumina into a silica gel column. After which, pass the filtered methylene chloride mixture through the column once, followed by eight 50-milliliter portions of methylene chloride. Finally, place the collected methylene chloride mixture into a rotary evaporator and evaporate-off the methylene chloride under vacuum until no more methylene chloride collects in the receiver flask. If a rotary evaporator is unavailable, place the mixture into a distillation apparatus and carefully distill-off the methylene chloride until no more methylene chloride is collected in the receiver flask. After the methylene chloride has been removed, remove the clear, very slightly yellow liquid product, and store it in a refrigerator until use. The yield of product will be about 173 grams.

Notes:

An example of a DIANP propellant

The following illustrates a common propellant composition containing DIANP. This example is not limited, and the additives such as ethyl cellulose or 2-nitrodiphenylamine can be replaced with others. Commercial & Industrial note: For related, or similar information, see Application No. 478,437, March 24, 1983, by Hercules Incorporated, to Ronald L. Simmons, Destin, FL, and Herbert L. Young, Shalimar, FL. Part or parts of the following process may be protected by international, and/or commercial/industrial processes. Before using this process to legally manufacture the mentioned propellant composition, with

intent to sell, consult any protected commercial or industrial processes related to, similar to, or additional to, the process discussed in this procedure. This process may be used to legally prepare the mentioned propellant composition for laboratory, educational, or research purposes.

Into a beaker, add 25 grams of nitrocellulose, 24 grams of ethyl cellulose, 1 gram of 2-nitrodiphenylamine, 100 grams of finely divided RDX, and then 50 grams of DIANP. Then cool this mixture in a cold-water bath, and blend the mixture rapidly for several hours to obtain a uniform mixture, free from globules, voids, and air pockets. After blending for several hours, the mixture should be extruded from an extruding machine, similar to a pasta machine into strands 1 to 2 millimeters thick by about 10 centimeters long. After which, the strands should be uniformly cut into pieces each one about 1 to 2 millimeters in diameter. Thereafter, the granules should be dried in a desiccator for several days at 30 to 40 Celsius. To use the granules, simply pack them tightly, or loosely into an appropriate rocket motor. Note: Do not use a blasting cap or detonator for initiation.

5-07. Diazodinitrophenol. 4,6,-Dinitro-2-diazophenol

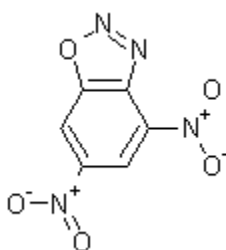

Diazodinitrophenol

Diazodinitrophenol forms bright yellow leaflets, which are very slightly soluble in water, and only slightly soluble in ether, alcohol, or benzene. It is very soluble in acetic acid, and stable in cold mineral acids. Diazodinitrophenol dissolves in warm nitrobenzene, or warm acetone without decomposition, and forms yellow transparent rectangular plates upon recrystallization there from; the latter when precipitated with ether. Diazodinitrophenol decomposes by hot concentrated sulfuric acid, cold bases, and many organic solvents. It decomposes when exposed to direct sunlight, and explodes violently when heated to 150 Celsius. Diazodinitrophenol detonates easily by sparks, fire, percussion, or friction. It can be compressed substantially without detonation or decomposition, but compressed samples can still be easily detonated. Diazodinitrophenol is less sensitive than mercury fulminate, and has a greater detonating velocity. It is a common primary explosive used in blasting caps, detonators, and gun primers. Diazodinitrophenol can be desensitized with dextrose, glue, pectin, sodium carbonate, or gypsum. Mixtures of Diazodinitrophenol with glass powder can be used in match compositions.

Molecular weight: 210.104	Flammability: Flashes when ignited
Detonating velocity: Uncalculated	Toxicity: Moderate
Sensitivity: Easily detonates	Classification: Primary explosive
Stability: Good	Overall value (as primary explosive): Very High

Procedure 5-07A: Preparation of Diazodinitrophenol

Materials:	1. 1850 grams sodium picramate
	2. 2660 milliliters of 20% hydrochloric acid
	3. 574.6 grams sodium nitrite

Summary: Diazodinitrophenol can be prepared by reacting sodium picramate with nitrous acid. The nitrous acid is generated on-sight by the reaction between sodium nitrite and hydrochloric acid. The diazodinitrophenol precipitates when it forms, due to the excessive amount water present in the reaction mixture. The product is then easily filtered-off, washed, and then dried. Commercial & Industrial note: For related, or similar information, see Serial No. 181,028, December 21st, 1937, by Hercules Powder Company, to Leon W. Babcock, Kenil, NJ. Part or parts of this laboratory process may be protected by international, and/or commercial/industrial processes. Before using this process to legally manufacture the mentioned explosive, with intent to sell, consult any protected commercial or industrial processes related to, similar to, or additional to, the process discussed in this procedure. This process may be used to legally prepare the mentioned explosive for laboratory, educational, or research purposes.

CHAPTER 5: THE PREPARATION OF AZIDES AND AZO NITROS

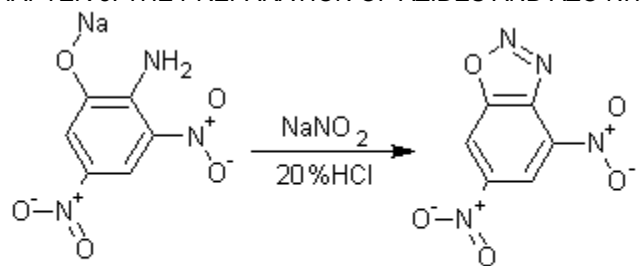

Sodium picramate

Diazodinitrophenol

Reaction Equation

Hazards: Wear gloves when handling 20% hydrochloric acid, which may cause skin irritation.

Procedure: Place 1850 grams of sodium picramate into a large flask equipped with a motorized stirrer, and then add 22 liters of water with rapid stirring. Thereafter, add and dissolve 574 grams of sodium nitrite into 2.52 liters of water at room temperature. Afterwards, rapidly add this sodium nitrite solution to the sodium picramate mixture, and then place the mixture into a cold-water bath at 15 Celsius. Then begin rapid stirring of the mixture. Then gradually add 2660 milliliters of 20% hydrochloric acid over a period of about 20 minutes with rapid stirring of the reaction mixture. After the addition, stir the mixture for about 10 minutes, and then stop stirring and then allow the reaction mixture to stand for ten minutes. Afterwards, filter-off the precipitated product, wash with several hundred milliliters of cold water, and then vacuum dry or air-dry the product.

Note: Do not store this material dry for long periods of time. For storage, store submerged in water free kerosene in tightly sealed amber glass bottles away from light.

Notes:

Procedure 5-07B: Preparation of Diazodinitrophenol

Materials:	1. 200 grams 99% nitric acid
	2. 440 grams of kerosene
	3. 80 grams of ammonium picramate
	4. 20 grams 95% ethanol

Summary: Diazodinitrophenol can be prepared by reacting ammonium picramate with nitric acid in the presence of kerosene and ethyl alcohol. The reaction mixture is then allowed to separate into layers, where upon the bottom layer is removed, and then added to cold water at a sufficient rate as to cause the diazodinitrophenol to precipitate in the form of a fine powder instead of larger lumps. The product is then filtered, washed, and then dried. Commercial & Industrial note: For related, or similar information, see Serial No. 343,592, December 9th, 1919, by William M Dehn, Seattle WA. Part or parts of this laboratory process may be protected by international, and/or commercial/industrial processes. Before using this process to legally manufacture the mentioned explosive, with intent to sell, consult any protected commercial or industrial processes related to, similar to, or additional to, the process discussed in this procedure. This process may be used to legally prepare the mentioned explosive for laboratory, educational, or research purposes.

CHAPTER 5: THE PREPARATION OF AZIDES AND AZO NITROS

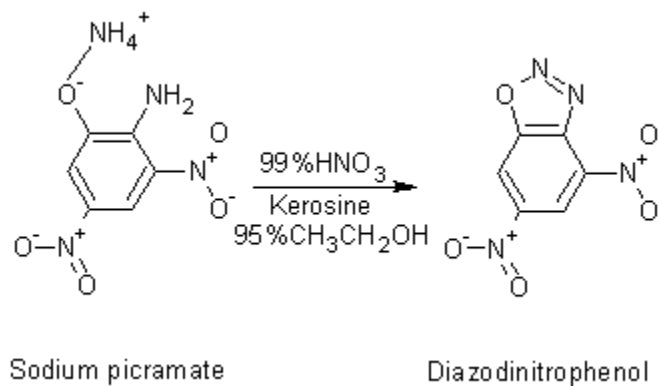

Reaction Equation

Hazards: Use maximum ventilation when handling 99% nitric acid, which evolves excessive fumes of nitrogen oxides. These fumes are very toxic and corrosive. Use great care. Kerosene and 95% ethanol are flammable, extinguish all flames before using.

Procedure: Note: This procedure uses an excessive amount of 99% nitric acid to properly carryout the reaction. This excessive amount of acid can be recovered by treating the reaction mixture (after complete removal of the product) with methylene chloride to recover the nitric acid. Prior to this action, a small amount of sulfuric acid should be added to the reaction mixture. Afterwards, the reaction mixture should be extracted with several volumes of methylene chloride. These combined volumes can then be carefully distilled to recover the nitric acid of 99% purity (see nitric acid, 90% and 99% respectively).

Place 200 grams of 99% nitric acid into a suitable flask, and then add 440 grams of kerosene. Afterwards, place this mixture into a water bath at room temperature. Note: The kerosene will form an upper layer. Then, prepare an ammonium picramate mixture by adding 80 grams of ammonium picramate to 20 grams of 95% ethanol, and then stir this mixture for several minutes. Thereafter, add this ammonium picramate mixture to the 99% nitric acid gradually over a period sufficient enough to keep the evolution of brown fumes to a minimum, and to keep the temperature below 30 Celsius. During the addition, rapidly stir the nitric acid mixture. After the addition, gradually, and slowly raise the temperature to about 98 Celsius with constant stirring until the evolution of gas ceases. Note: During the gradual heating process, if the evolution of gas ceases before the temperature reaches 98 Celsius, remove the heat source. When the evolution of gas ceases, remove the heat source, and then allow the reaction mixture to cool to room temperature. After which, allow the reaction mixture to stand for ten minutes. A brownish-red lower layer, and a clear upper layer will form. Then place this mixture into a seperatory funnel, and then allow it to stand for 10 or 15 minutes. Note: if a yellowish precipitate forms, add some more nitric acid to re-dissolve it. Thereafter, drain-off the bottom acid layer. Then slowly add the bottom acid layer into 1000 milliliters of cold water at a rate sufficient enough to precipitate the product in the form of a fine powder instead of lumps. During the addition, moderately stir the water. After adding the entire bottom acid layer to the water, stop siring, and allow the mixture to stand. After which, filter-off the precipitated product, wash with several hundred milliliters of cold water, and then vacuum dry or air-dry the product.

Note: Do not store this material dry for long periods of time. For storage, store submerged in water free kerosene in tightly sealed amber glass bottles away from light.

Notes:

Procedure 5-07C: Preparation of Diazodinitrophenol

Materials:	1. 12 grams methyl green (indicator no. 684)
	2. 960 grams sodium picramate
	3. 772 milliliters 35 - 38% hydrochloric acid
	4. 326 grams sodium nitrite

Summary: Diazodinitrophenol is prepared by reacting sodium picramate with sodium nitrite, and hydrochloric acid. Diazodinitrophenol is then precipitated in a special manner by the addition of a methyl green indicator. The methyl green

CHAPTER 5: THE PREPARATION OF AZIDES AND AZO NITROS

indicator plays no actual role in the chemical reaction, but it simply allows the Diazodinitrophenol to precipitate. Commercial & Industrial note: Part or parts of this laboratory process may be protected by international, and/or commercial/industrial processes. Before using this process to legally manufacture the mentioned explosive, with intent to sell, consult any protected commercial or industrial processes related to, similar to, or additional to, the process discussed in this procedure. This process may be used to legally prepare the mentioned explosive for laboratory, educational, or research purposes.

Hazards: Note: sodium picramate is also a high explosive. Wear gloves and use proper ventilation when handling 35% hydrochloric acid. 35% Hydrochloric acid is highly corrosive and toxic.

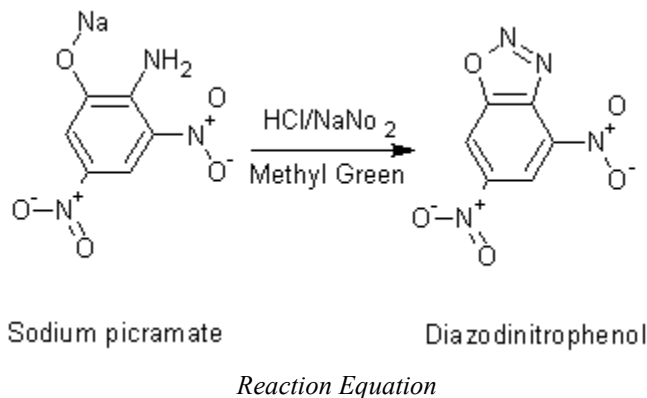

Procedure: Prepare a suspension of sodium picramate in water by adding 960 grams sodium picramate to 12000 milliliters water, and mix thoroughly. To this suspension, add 12 grams of methyl green indicator. Afterwards, prepare an acid solution by adding 772 milliliters of 35% hydrochloric acid to 960 milliliters of water, and then add the hydrochloric acid solution to the suspension while rapidly stirring the suspension. After the addition, cool the suspension mixture to 10 Celsius by the means of an ice water bath. Then dissolve 326 grams of sodium nitrite into 1440 milliliters of water, and add this sodium nitrite solution to the cooled suspension, drop wise, over a 50-minute period while maintaining the temperature of the suspension at 10 Celsius, and continuously stirring. After the addition of the sodium nitrite solution, continue stirring the reaction mixture, and maintain its temperature at 10 Celsius for 2 hours. After 2 hours, stop stirring, and allow the precipitate to settle. After the precipitate has settled, decant (remove) the liquid above the precipitate as much as possible without pouring any of the precipitate out. After which, add 1000 milliliters of water to the precipitate, and stir for ten minutes. After which, stop stirring and allow the precipitate to settle. Again, remove the liquid above the precipitate as much as possible without pouring out any of the precipitate. Repeat this process 2 more times with 1000 milliliters of water each time. After the last washing with 1000 milliliters of water, filter the precipitate using gravity filtration or preferably vacuum filtration, and then vacuum dry or air-dry the product (do not use heat to dry the solid). The result will be about 800 grams of diazodinitrophenol.

Note: Do not store this material dry for long periods of time. For storage, store submerged in water free kerosene in tightly sealed amber glass bottles away from light.

Notes:

5-08. HNTCAB. Hexanitrotetrachloroazobenzene; 2,4,6,2',4',6'-Hexanitro-3,5,3',5'-tetrachloroazobenzene

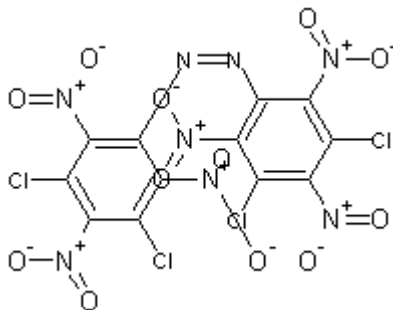

HNTCAB

HNTCAB is a powerful poly-nitro explosive used in heat resistant explosive compositions, and it may be satisfactorily used as a replacement for TNT in composition B charges (mixed with RDX). The compound is stable, but may detonate under severe shock, or percussion.

Molecular weight: 589.986	Flammability: Flashes when strongly ignited
Detonating velocity: 7000 (estimated)	Toxicity: Moderate
Sensitivity: Requires blasting cap	Classification: Secondary explosive
Stability: Good	Overall value (as secondary explosive): High

Procedure 5-08A: Preparation of HNTCAB

Materials:	1. 56 milliliters of 90% nitric
	2. 82 grams of 30% fuming sulfuric acid
	3. 20 grams of powdered 3,5-dichloroaniline
	4. 800 milliliters of 98% sulfuric acid

Summary: Hexanitrotetrachloroazobenzene is prepared by reacting 90% nitric acid, 30% fuming sulfuric acid, and 98% sulfuric acid with 3,5-dichloroaniline. The reaction mixture is then heated, and then poured over ice to precipitate the product. The product is then collected by filtration, and then recrystallized from an acetone/hexane solvent mixture to yield pure HNTCAB. Commercial & Industrial note: For related, or similar information, see Application No. 946,859, December 29, 1986, by Texas Explosives Co. Inc., to David M. O'Keefe, Mansfield, TX. Part or parts of this laboratory process may be protected by international, and/or commercial/industrial processes. Before using this process to legally manufacture the mentioned explosive, with intent to sell, consult any protected commercial or industrial processes related to, similar to, or additional to, the process discussed in this procedure. This process may be used to legally prepare the mentioned explosive for laboratory, educational, or research purposes.

Hazards: Warning! Wear gloves and use proper ventilation when handling 90% nitric acid, and 30% fuming sulfuric acid. 90% Nitric acid is a highly toxic and corrosive liquid, which evolves highly poisonous fumes of nitrogen oxides. 30% fuming sulfuric acid is a very toxic and corrosive liquid, which evolves toxic and corrosive fumes. Use great care. Wear gloves when handling 98% sulfuric acid, which can cause severe skin burns.

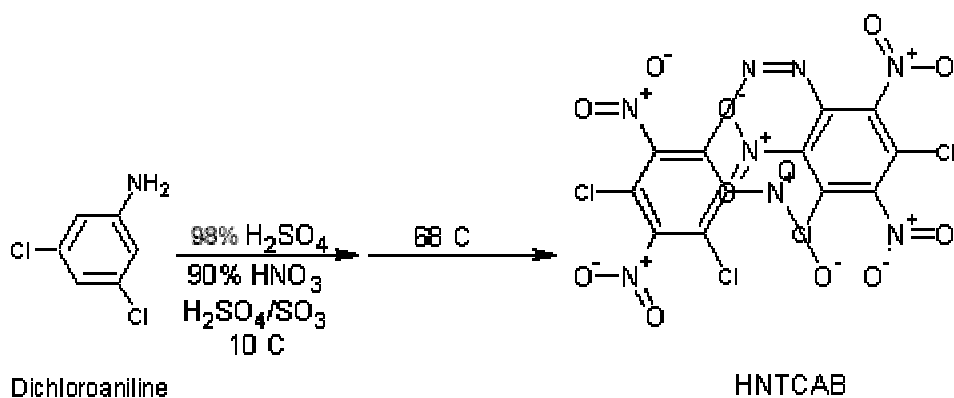

Reaction Equation

Procedure: Prepare a nitrating acid mixture by adding 56 milliliters of 90% nitric acid to a flask, and then add 800 milliliters of 98% sulfuric acid and 82 grams of 30% fuming sulfuric acid. Then cool the acid mixture to 10 Celsius by means of an ice water bath, and then stir the acid mixture. Then slowly add, portion wise, 20 grams of 3,5-dichloroaniline over a 30-minute period while stirring the acid mixture, and maintain its temperature at 10 Celsius. After the addition of the 3,5-dichloroaniline, stir the reaction mixture for an additional 30-minutes at 10 Celsius. Afterwards, remove the ice water bath, and slowly heat the reaction mixture to 68 Celsius. Thereafter, heat at 68 Celsius for 2 hours while constantly stirring the reaction mixture. After heating for 2 hours, remove the heat source, and allow the reaction mixture to cool to room temperature. Then place the reaction mixture into an ice water bath for 20 minutes. After which, pour the entire reaction mixture onto 2 kilograms of ice contained in a large beaker. After the ice has melted, filter-off the precipitated product, wash with 1000 milliliters of coldwater, and then vacuum dry or air-dry. Then recrystallize the product from 2000 milliliters of a solvent mixture prepared by mixing 1000 milliliters of acetone with 1000 milliliters of hexane. After the recrystallization process, wash with 1000 milliliters of water, and then vacuum dry or air-dry the product. The yield of dry product will be 24 grams in the form of a fluffy orange solid with a melting point at 308 Celsius.

Notes:

5-09. DNAT. 1,1'-dinitro-3,3'-azo-1,2,4-triazole

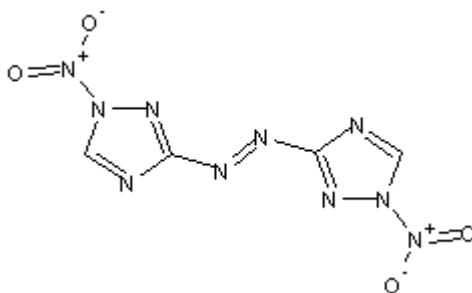

DNAT

Uses: Can be used in pyrotechnic compositions for fireworks, flares, incendiary agents, and primary explosive compositions for blasting caps and detonators. It can also be used with satisfactory results in rocket propellants.

Molecular weight: 254.124	Flammability: Flashes when strongly ignited
Detonating velocity: Uncalculated	Toxicity: Moderate
Sensitivity: Moderate	Classification: Secondary explosive
Stability: Good	Overall value (as secondary explosive): High

Procedure 5-08A: Preparation of DNAT

Materials:	1. 42 grams potassium permanganate
	2. 17 grams 3-amino-1,2,4-triazole
	3. 8 grams sodium hydroxide
	4. 30 grams sodium bisulfite
	5. 100 milliliters 35 - 38% hydrochloric acid
	6. 10 milliliters 99% nitric acid
	7. 22 milliliters acetic anhydride
	8. 560 milliliters of acetone

Summary: DNAT, 1,1'-dinitro-3,3'-azo-1,2,4-triazole, is prepared by oxidizing 3-amino-1,2,4-triazole to 3,3'-azo-1,2,4-triazole with potassium permanganate, and then treating that intermediate with nitric acid in the presence of acetic anhydride. The precipitated product is then recovered by filtration, and then recrystallized from acetone. Commercial & Industrial note: Part or parts of this laboratory process may be protected by international, and/or commercial/industrial processes. Before using

CHAPTER 5: THE PREPARATION OF AZIDES AND AZO NITROS

this process to legally manufacture the mentioned explosive, with intent to sell, consult any protected commercial or industrial processes related to, similar to, or additional to, the process discussed in this procedure. This process may be used to legally prepare the mentioned explosive for laboratory, educational, or research purposes.

Hazards: Warning! Use proper ventilation when handling 99% nitric acid. 99% nitric acid is a highly toxic corrosive liquid evolving highly poisonous fumes of nitrogen oxides. Use great care. Use proper ventilation when handling 35 – 38% hydrochloric acid, which is a highly corrosive and toxic liquid evolving choking and corrosive fumes. Extinguish all flames and do no smoke when handling acetone. Acetone is a highly flammable and volatile liquid. Wear gloves when handling acetic anhydride, which can cause skin burns.

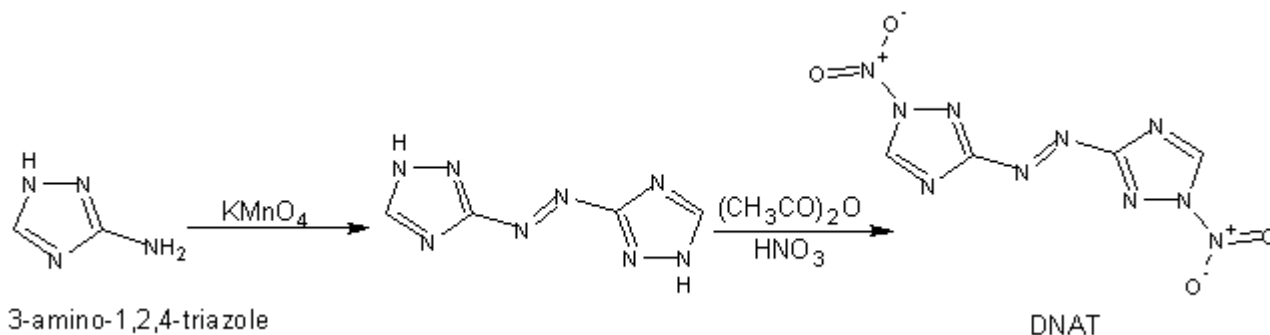

Reaction Equation

Procedure:

Step 1: Preparation of 3,3'-azo-1,2,4-triazole

Prepare a solution by adding 17 grams of 3-amino-1,2,4-triazole, and 8 grams of sodium hydroxide into 100 milliliters of water. Then cool this solution to 0 Celsius by means of an ice bath. Then, while continuously stirring the solution, slowly add 21 grams of potassium permanganate while keeping the temperature of the reaction mixture at 0 Celsius. After all the potassium permanganate has been added and dissolved, remove the ice bath, and then heat the reaction mixture to about 60 Celsius. When the temperature reaches 60 Celsius, slowly add 21 grams of additional potassium permanganate while stirring the reaction mixture, and maintain its temperature at 60 Celsius. After the second batch of potassium permanganate has been added and dissolved, remove the heat source and, allow the reaction mixture to cool to about 50 Celsius. When the temperature reaches about 50 Celsius, rapidly add 30 grams of sodium bisulfite, stir for five minutes, and then filter the hot liquid to remove insoluble impurities. After filtration, rapidly add 100 milliliters of 35 – 38% hydrochloric to the hot filtered reaction mixture while stirring the reaction mixture. The 3,3'-azo-1,2,4-triazole product will precipitate. After the addition, allow the reaction mixture to cool to room temperature, and then filter-off the product. Thereafter, wash the product with 400 milliliters of water, and then 60 milliliters of acetone. Afterwards, vacuum dry or air-dry the product.

Step 2: Preparation of 1,1'-dinitro-3,3'-azo-1,2,4-triazole

Prepare a nitrating acid mixture by adding 10 milliliters of 99% nitric acid to 22 milliliters of acetic anhydride, and then cool the mixture to 0 Celsius by means of an ice bath. When the temperature of the nitrating acid reaches 0 Celsius, slowly add 3 grams of 3,3'-azo-1,2,4-triazole (prepared in step 1) while stirring the nitrating acid, and keep its temperature at 0 Celsius. After the addition of the 3,3'-azo-1,2,4-triazole, continue stirring the reaction mixture at 0 Celsius for 1 hour. Afterwards, remove the ice bath, and then pour the entire reaction mixture into 500 milliliters of ice water. Then place this entire mixture into an ice bath and keep at 0 Celsius for 12 hours (a refrigerator cooled to 0 Celsius can be used instead of the ice bath). After 12 hours, filter-off the precipitated product, wash with 400 milliliters of cold water, and then vacuum dry or air-dry. After drying, recrystallize the product from 500 milliliters of acetone, and then wash with 400 milliliters of water. Thereafter, vacuum dry or air-dry the product. The product will be in the form a yellowish crystalline solid.

Notes:

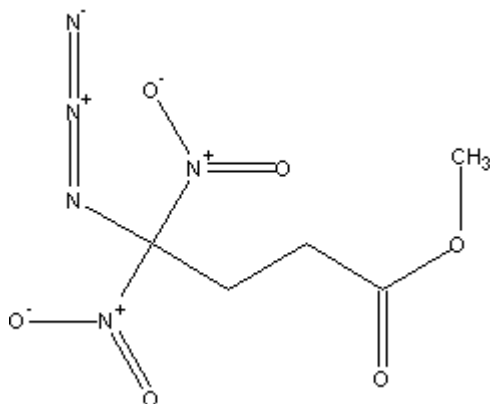
5-10. ADNB. *4-Azido-4,4-dinitro-1-butyl acetate*

ADNB

Uses: Shows remarkable properties for use in nitroglycerine free dynamites, and as a replacement for nitroglycerine or propylene glycol dinitrate in military smokeless powders.

Molecular weight: 233.14	Flammability: Detonates when ignited
Detonating velocity: Uncalculated	Toxicity: Moderate
Sensitivity: Moderate	Classification: Secondary explosive
Stability: Good	Overall value (as secondary explosive): High

Procedure 5-10A: Preparation of ADNB

Materials:	1. 78.4 grams 4,4-DNB
	2. 200 milliliters of methylene chloride
	3. 130 grams anhydrous magnesium sulfate
	4. 120 milliliters of 30% sodium azide solution
	5. 4 grams sodium hydroxide
	6. 210 milliliters methylene chloride
	7. 46 milliliter of acetyl chloride
	8. 30 milliliters ethyl acetate
	9. 270 milliliters hexanes

Summary: ADNB is prepared in a two-step process starting with the acetylation of 4,4-DNB. The 4,4-DNB is treated with acetyl chloride in methylene chloride solution, and the resulting mixture treated with ice water. The lower methylene chloride layer is removed, dried over magnesium sulfate, and then evaporated to yield the intermediate, 4,4-dinitro-1-butyl acetate. This acetate is then placed into a H-cell and sodium azide and sodium hydroxide added to the anode compartment. The apparatus is then electrolyzed for several hours. After which, the contents of the anode are recovered, extracted with methylene chloride, and then acetylated with acetyl chloride in methylene chloride. The resulting mixture is then passed through a silica gel column for purification. The product is then recovered by evaporation of the solvents. Commercial & Industrial note: For related, or similar information, see Application No. 082,879, February 13th, 1990, by The United States Air Force, to Milton B. Frankel, Tarzana, CA, and James F. Weber, Moorpark, CA. Part or parts of this laboratory process may be protected by international, and/or commercial/industrial processes. Before using this process to legally manufacture the mentioned explosive, with intent to sell, consult any protected commercial or industrial processes related to, similar to, or additional to, the process discussed in this procedure. This process may be used to legally prepare the mentioned explosive for laboratory, educational, or research purposes.

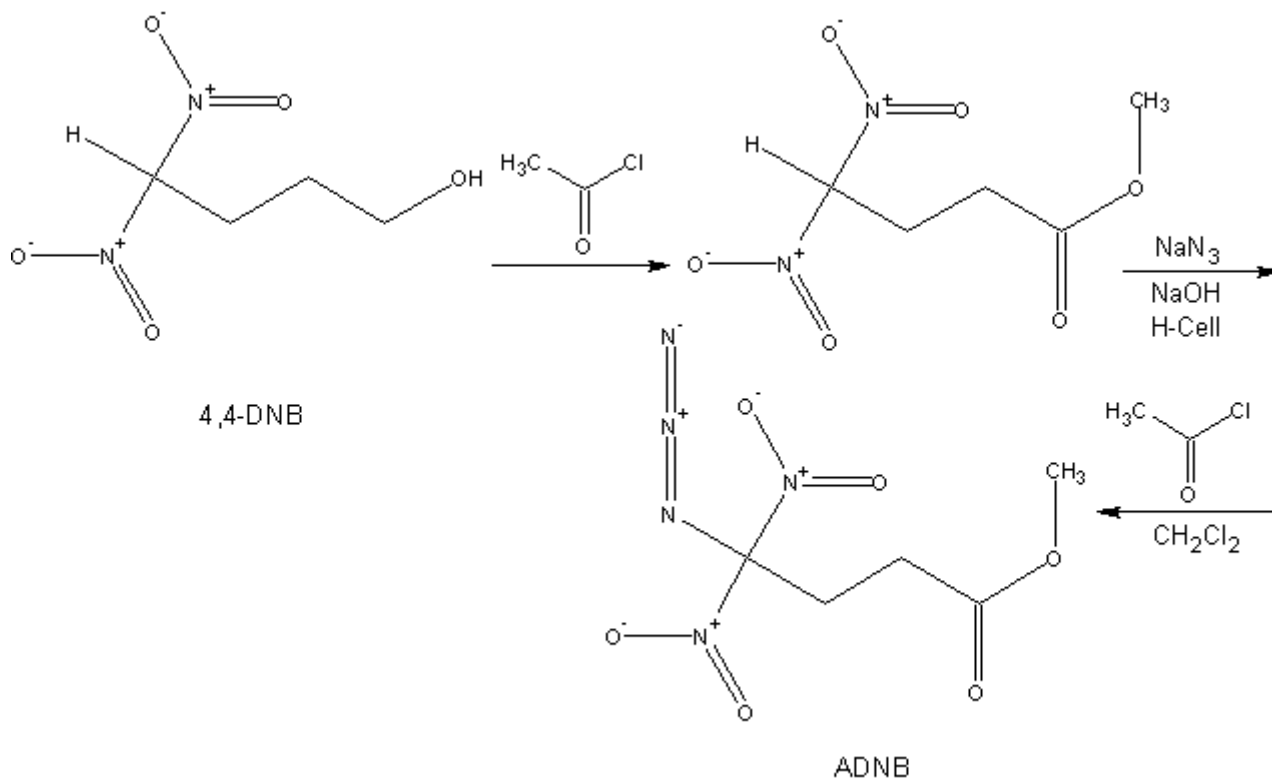
*Reaction Equation*

Hazards: Do not store 30% sodium azide solution for prolonged periods of time. Extinguish all flames before using ethyl acetate and hexanes, and avoid inhalation of vapors. Wear gloves when handling acetyl chloride, which is corrosive, and avoid inhalation of vapors.

Procedure:

Step 1: Preparation of 4,4-dinitro-1-butyl acetate

Place 78.4 grams of 4,4-DNB into a beaker and then add 200 milliliters of methylene chloride. Stir the mixture to ensure the 4,4-DNB dissolves. After the solution is complete, gradually add 44 milliliters of acetyl chloride over a period of 180 minutes while stirring the 4,4-DNB solution at room temperature. After the addition, pour in 400 milliliters of ice water while stirring. Thereafter, remove the bottom methylene chloride layer, and then add 100 grams of anhydrous magnesium sulfate with stirring. After which, filter-off the magnesium sulfate, and then place the methylene chloride mixture into a rotary evaporator and evaporate-off the methylene chloride under vacuum until no more methylene chloride collects in the receiver flask. If a rotary evaporator is unavailable, place the mixture into a distillation apparatus and carefully distill-off the methylene chloride until no more methylene chloride collects in the receiver flask. Afterwards, remove the light yellow oil, and keep for step 2. The result will be about 85.4 grams of a light yellow oil.

Step 2: Preparation of ADNB

Assemble the electro-chemical cell as illustrated below. Then add 20.4 grams of 4,4-dinitro-1-butyl acetate (prepared in step 1), 50 milliliters of 30% sodium azide solution, and then a sodium hydroxide solution prepared by dissolving 4 grams sodium hydroxide into 6 milliliters of water to the anode(+) compartment. Then add 70 milliliters of sodium azide solution into the cathode(-) compartment. Thereafter, place a stainless steel electrode as the cathode electrode into the cathode compartment, followed by a platinum foil electrode as the anode electrode in the anode compartment. After which, electrolysis the apparatus at 650 milliamp for 10 and ½ hours. After electrolyzing the apparatus for 10.5 hours, stop the process, and then remove the contents of the anode compartment to a separatory funnel. Thereafter, extract the mixture with six 25-milliliter portions of methylene chloride. After the extraction process, combine all methylene chloride portions, if not already done so, and wash the combined methylene chloride with four 100-milliliters portions of warm water. Note: during the washing, the methylene chloride will be the bottom layer. After the washing, add 20 grams of anhydrous magnesium sulfate, and stir the mixture for several minutes. Then, filter-off the magnesium sulfate, and then place the filtered methylene chloride mixture into a rotary evaporator, and evaporate-off the methylene chloride until no more methylene chloride is collected in the receiver flask. If a

CHAPTER 5: THE PREPARATION OF AZIDES AND AZO NITROS

rotary evaporator is unavailable, place the mixture into a distillation apparatus and carefully distill-off the methylene chloride until no more methylene chloride passes into the receiver flask. Thereafter, remove the liquid residue left over, and then add it to a solution prepared by dissolving 2 milliliters of acetyl chloride into 60 milliliters of methylene chloride while stirring the methylene chloride mixture. After which, stir the mixture for 4 hours at room temperature. Thereafter, drown the entire mixture into 200 milliliters of ice water, and then remove the lower methylene chloride layer. Thereafter, add 10 grams of anhydrous magnesium sulfate, and stir the mixture for several minutes. Then, filter-off the magnesium sulfate, and then once again, place the mixture into rotary evaporator and evaporate-off the methylene chloride. Again, if a rotary evaporator is not available, use a distillation apparatus. Then purify the crude yellow oil obtained, by passing it through a silica gel column filled with silica gel. After the passing, pass six 50-gram portions of 10% ethyl acetate in hexanes, prepared by dissolving 30 milliliters of ethyl acetate into 270 milliliters of hexanes. Finally, place the collected mixture into a rotary evaporator and evaporate-off the methylene chloride, ethyl acetate, and hexanes until no more solvent passes into the receiver flask. Thereafter, remove the liquid product, and store in a refrigerator until use. The purified liquid product will be a clear, light yellow oil.

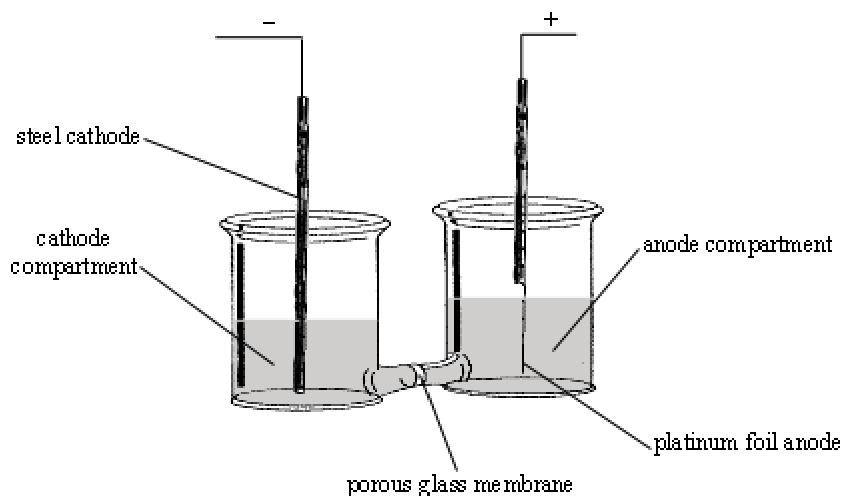
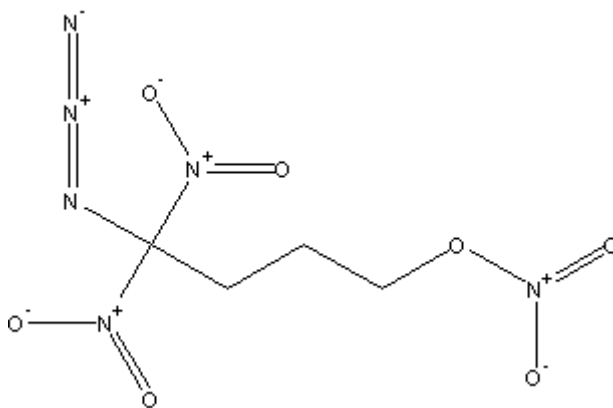

Figure 036. H-Cell for electro-chemical reaction

Notes:

5-11. ADBN. *4-Azido-4,4-dinitro-1-butyl nitrate*



ADBN

ADBN is a high-energy compound suitable for use as a high-energy plasticizer in flexible sheet explosives along with RDX, TNT, HMX, and HNIW. It can also be used as an additive for explosive compositions, and is very useful in rocket propellants

CHAPTER 5: THE PREPARATION OF AZIDES AND AZO NITROS

because the azide functional group provides extra energy upon ignition, and results in flash suppression, and smoke reduction. ADBN is also capable of forming dynamites with nitroglycerine and inert fillers.

Molecular weight: 250.127	Flammability: Generally non flammable but may flash
Detonating velocity: Similar to nitroglycerine	Toxicity: Moderate
Sensitivity: Moderate	Classification: Secondary explosive
Stability: Good	Overall value (as secondary explosive): High

Procedure 5-11A: Preparation of ADBN

Materials:	1. 16 grams 35 – 38% hydrochloric acid
	2. 184 milliliters methanol
	3. 9.2 grams ADNB
	4. 310 milliliters methylene chloride
	5. 2 grams of 99% nitric acid
	6. 100 milliliters of 10% baking soda solution
	7. 20 grams of anhydrous magnesium sulfate

Summary: ADBN is prepared in a two step process starting with the preparation of 4-azido-4,4-dinitro-1-butanol. This intermediate is prepared by reducing ADNB with hydrochloric acid in the presence of methanol. The resulting mixture is then filtered, concentrated, and the recovered crude product dissolved into methylene chloride. This solution is then purified by passing through a silica gel column. The collected liquid is then evaporated. The recovered 4-azido-4,4-dinitro-1-butanol is then nitrated with 99% nitric acid in methylene chloride. The resulting reaction mixture is then washed, and then evaporated to yield the product. Commercial & Industrial note: For related, or similar information, see Application No. 082,879, February 13th, 1990, by The United states Air Force, to Milton B. Frankel, Tarzana, CA, and James F. Weber, Moorpark, CA. Part or parts of this laboratory process may be protected by international, and/or commercial/industrial processes. Before using this process to legally manufacture the mentioned explosive, with intent to sell, consult any protected commercial or industrial processes related to, similar to, or additional to, the process discussed in this procedure. This process may be used to legally prepare the mentioned explosive for laboratory, educational, or research purposes.

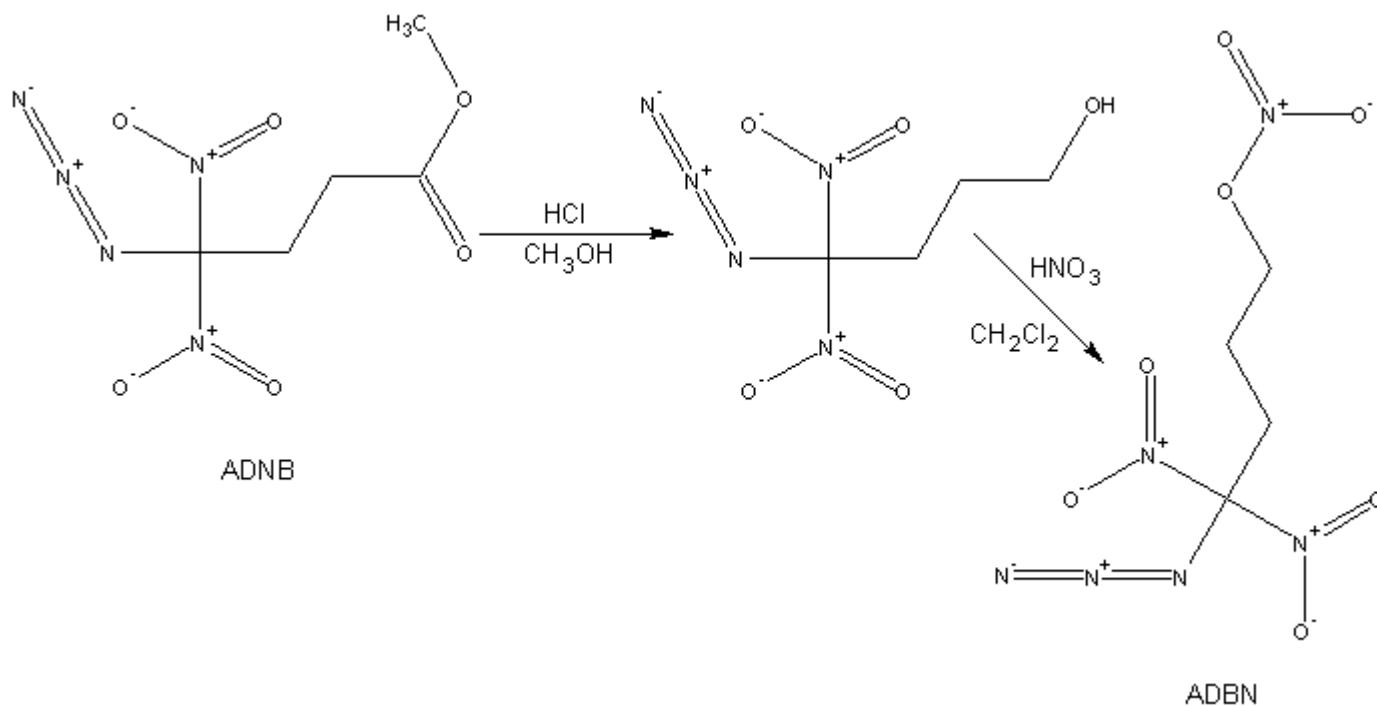

Reaction Equation

Hazards: 99% nitric acid is highly corrosive, and toxic, use proper ventilation when handling. Wear gloves and use proper ventilation when handling concentrated hydrochloric acid. Concentrated hydrochloric acid evolves choking corrosive fumes. Avoid inhalation of fumes. Avoid inhalation or skin absorption from methanol. Ingestion of methanol may be fatal.

Procedure:

Step 1: Preparation of 4-azido-4,4-dinitro-1-butanol

Take 16 grams of 35 – 38% hydrochloric acid, and dissolve it into 184 milliliters of methanol. Thereafter, add 9.2 grams of ADNB, and then stir the mixture for 4 hours at room temperature. Thereafter, filter the mixture to remove any insoluble materials, and then place the mixture into a rotary evaporator and evaporate-off the methylene chloride. If a rotary evaporator is unavailable, place the mixture into a distillation apparatus and carefully distill-off the methylene chloride. When all the methylene chloride has been removed, remove the oily liquid remaining, and then dissolve in 120 milliliters of methylene chloride. Then, pass this methylene chloride mixture through a silica gel column filled with silica gel, followed by six 20-milliliter portions of methylene chloride. After the passings, place the collected methylene chloride mixture into a rotary evaporator and evaporate-off the methylene chloride until a clear oily liquid remains. Then remove this liquid product, and keep for step 2.

Step 2: Preparation of ADBN

Prepare a solution, solution A, by dissolving 6.2 grams of 4-azido-4,4-dinitro-1-butanol (prepared in step 1) into 20 milliliters of methylene chloride. Then, prepare a second solution, solution B, by dissolving 2 grams of 99% nitric acid into 50 milliliters of methylene chloride. Then, place solution B into an ice bath, and chill to about 0 Celsius. Thereafter, gradually add, drop wise, solution A to solution B while rapidly stirring solution B, and maintaining its temperature below 5 Celsius. After the addition, remove the ice bath, and allow the reaction mixture to warm to room temperature. Then stir at room temperature for 2 hours. After which, pour the entire reaction mixture into 200 milliliters of ice water. Then remove the bottom methylene chloride layer, and then wash with 100 milliliters of 10% baking soda solution, followed by 200 milliliters of warm water. Note: after each washing, the methylene chloride will be the bottom layer. After washing, stir in 20 grams of anhydrous magnesium sulfate, and then filter-off the magnesium sulfate after stirring for several minutes. Then, place the methylene chloride mixture into rotary evaporator, and evaporate-off the methylene chloride. A distillation apparatus can be used to remove the methylene chloride. After the methylene chloride has been removed, remove it, and place it into an amber glass bottle, and store in a refrigerator until use. The result will be 6 grams of the product.

Notes:

CHAPTER 6: THE PREPARATION OF AZA/OXA NITRAMINES

TNTC, DDD, TEX, DNFA-P

6-01. TNTC. 2,4,6-trinitro-2,4,6-triazacyclohexanone

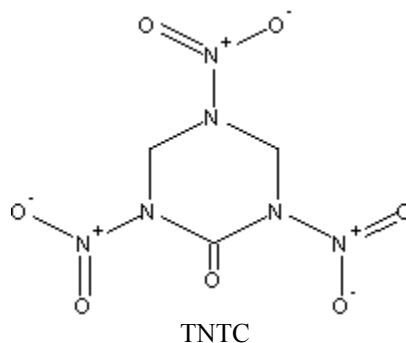

Uses: Substitute for RDX, or HMX in explosives compositions, main component of explosives compositions or rocket propellants, and main ingredient in base charges for blasting caps.

Molecular weight: 236.1	Flammability: Burns with smoky flame
Detonating velocity: Similar to RDX	Toxicity: Mild
Sensitivity: Very low (requires blasting cap)	Classification: Secondary explosive
Stability: Very good	Overall value (as secondary explosive): Very high

Procedure 6-01A: Preparation of TNTC

Materials:	1. 120 milliliters trifluoroacetic anhydride
	2. 400 milliliters nitromethane
	3. 49.2 grams ammonium nitrate
	4. 18.2 gram NIHT.HCl
	5. 100 milliliters ethyl acetate

Summary: TNTC is prepared by treating NIHT.HCl with nitromethane and ammonium nitrate in the presence of trifluoroacetic anhydride. After the reaction, the TNTC is contaminated with a by-product and hence needs to be purified. To do this, the contaminated TNTC is treated with ethyl acetate, and recrystallized. Commercial & Industrial note: For related, or similar information, see Application No. 471,906, January 29, 1990, by Gencorp Aerojet, to Der-Shing Hunag, Folsom, CA. Part or parts of this laboratory process may be protected by international, and/or commercial/industrial processes. Before using this process to legally manufacture the mentioned explosive, with intent to sell, consult any protected commercial or industrial processes related to, similar to, or additional to, the process discussed in this procedure. This process may be used to legally prepare the mentioned explosive for laboratory, educational, or research purposes.

Hazards: Wear gloves and insure proper ventilation when handling trifluoroacetic anhydride. Trifluoroacetic anhydride is corrosive, and can cause skin burns. Nitromethane is highly flammable.

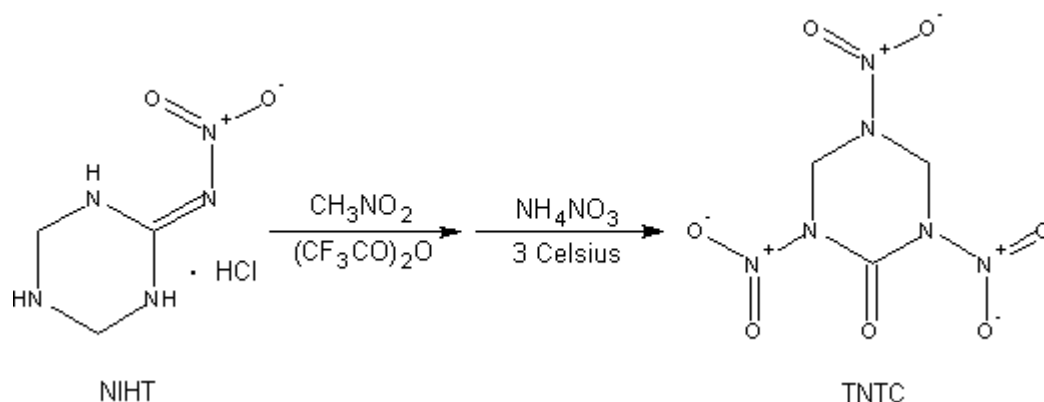
*Reaction Equation*

Procedure: To a 3-neck 2000-milliliter flask fitted with a condenser, a magnetic stirrer, and a thermometer, add 120 milliliters of trifluoroacetic anhydride, and 400 milliliters of nitromethane. Then cool the mixture to about 3 Celsius using an ice bath. Then add 49.2 grams of ammonium nitrate in one portion and maintain the reaction mixture at 3 Celsius and stir. Then stir the reaction mixture for 1 hour at 3 Celsius. After 1 hour, add 18.2 grams of NIHT.HCl in several portions over a 30-minute period while keeping the reaction mixture at 3 Celsius and stirring. After the addition of the NIHT.HCl, cool the reaction mixture at 3 Celsius for 13 hours. After 13 hours, remove the ice bath, and then gradually warm the reaction mixture to room temperature overnight. Then vacuum filter the slurry to collect the precipitated product, and then wash the precipitated product with 1000 milliliters of cold water. The washed precipitated product will be contaminated with a by-product of approximately a 1:1 weight ratio. To remove this by-product, mix the washed precipitated product with 100 milliliters of ethyl acetate and stir the mixture for 20 minutes at room temperature. After stirring for 20 minutes, filter-off the insoluble by-product, and then place the ethyl acetate solution containing the dissolved product into a distillation apparatus. Then distill-off the ethyl acetate at 78 Celsius until dry solid product remains (the distillation may have to be temporarily stopped several times in order to filter-off precipitated product). If a rotary evaporator is available, evaporate-off the ethyl acetate under vacuum. When dry solid is obtained, remove the heat source, and then collect the dry product and cool it to room temperature (vacuum filter or air dry any filtered-off product obtained during the distillation, and then add it to the rest of dry product). Then wash the entire dry product with 400 milliliters of cold water, and then vacuum dry or air dry.

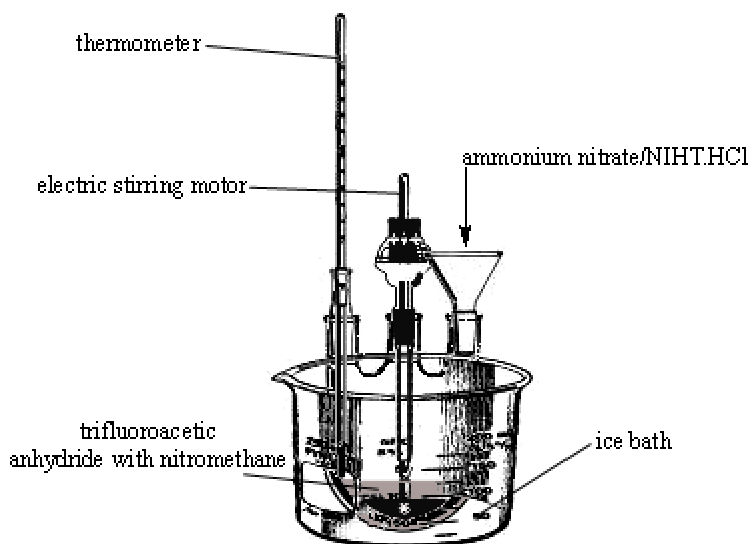
**Figure 037. Apparatus for TNTC preparation.**

Notes:

Azadine TNTC/Aluminum plastic bonded explosive

Add 132 grams of TNTC into 1000 milliliters of water, and stir for ten minutes until a slurry forms. Then add 18 grams of Elvamid 8061 (commercially available), and then heat the mixture with rapid stirring to 90 Celsius. Afterwards, add 50 grams of powdered aluminum and continue rapid stirring and heating for 4 hours. After heating and stirring for 4 hours, remove the heat source and allow the explosive mixture to cool to room temperature. After which, place the explosive into a shallow pan and allow it to dry at room temperature for several days. After drying, press the explosive into any desirable mold, container, bomb casing, or warhead casing under high pressure. Requires a blasting cap or detonator for initiation. Commercial & Industrial note: Part or parts of this laboratory process may be protected by international, and/or commercial/industrial processes. Before using this process to legally manufacture the mentioned explosive, with intent to sell, consult any protected commercial or industrial processes related to, similar to, or additional to, the process discussed in this procedure. This process may be used to legally prepare the mentioned explosive for laboratory, educational, or research purposes.

TNTC plastic bonded explosive composition

Place 1204 grams of TNTC into a beaker, and then add 30.6 grams of polypropylene glycol. Then 160 milliliters of water, and then rapidly blend the mixture for 2 hours. After 2 hours, place the mixture into a shallow pan, and then dry the mixture at 50 Celsius for 24 hours in an oven. After the mixture is dried, press the explosive into sheets under high pressure, or press into any desirable mold or container under high pressure. For demolitions use, remove the pressed explosive from the container and then wrap in paper, plastic or cardboard. The explosive should be pressed into rectangular containers or molds of 2 inches width by 5 to 11 inches long. Requires a blasting cap or detonator for initiation.

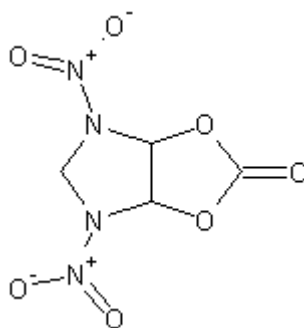
6-02. DDD. 5,7-dinitro-5,7-diaza-1,3-dioxabicyclo[3:3:0]octan-2-one

DDD

Uses: Addictive with TEX in explosives compositions or high performance rocket propellants—decreases smoke emissions.

Molecular weight: 220.097	Flammability: Burns with smoky flame
Detonating velocity: Similar to TNTC	Toxicity: Mild
Sensitivity: Very low (requires blasting cap)	Classification: Secondary explosive
Stability: Very good	Overall value (as secondary explosive): Very high

Procedure 6-02A: Preparation of DDD

Materials:	1. 20 grams triethylamine
	2. 390 milliliters acetonitrile
	3. 13.6 grams methylenedinitramine
	4. 19.2 grams 4,5-dichloro-1,3-dioxolan-2-one
	5. 80 grams EM Grade silica gel
	6. 100 milliliters benzene
	7. 30 milliliters 95% ethanol (ABS alcohol; grain alcohol)

Summary: DDD is made by reacting methylenedinitramine with 4,5-dichloro-1,3-dioxolan-2-one in a solvent called acetonitrile. Triethylamine is added to neutralize the hydrogen chloride gas produced in the reaction. The hydrogen chloride gas must be neutralized in order to preserve the reaction rate. The triethylamine does not play a direct role in the production of

CHAPTER 6: THE PREPARATION OF AZA/OXA NITRAMINES

DDD. Commercial & Industrial note: For related, or similar information, see Application No. 059,929, May 10, 1993, by The United States Navy, to Michael Chaykovsky, Columbia, MD, William M. Koppes, Adelphi, MD. Part or parts of this laboratory process may be protected by international, and/or commercial/industrial processes. Before using this process to legally manufacture the mentioned explosive, with intent to sell, consult any protected commercial or industrial processes related to, similar to, or additional to, the process discussed in this procedure. This process may be used to legally prepare the mentioned explosive for laboratory, educational, or research purposes.

Hazards: Wear gloves and use proper ventilation when handling benzene. Benzene is a carcinogen and is toxic, so use caution. Wear gloves and use proper ventilation when handling acetonitrile.

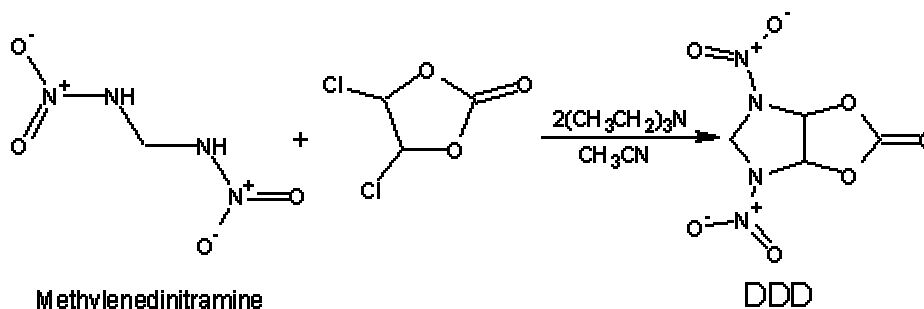

Reaction Equation

Procedure: Dissolve 20 grams triethylamine in 50 milliliters of acetonitrile. Then place 300 milliliters of acetonitrile into a separate flask, and then cool to 0 Celsius by means of an ice bath. Then add 13.6 grams of methylenedinitramine and 19.2 grams of 4,5-dichloro-1,3-dioxolan-2-one (usually available as a 85% technical grade solution) into the 300 milliliters of acetonitrile while stirring the acetonitrile, and maintaining its temperature at 0 Celsius. Then slowly add the triethylamine/acetonitrile solution drop-wise, to acetonitrile mixture over a 40-minute period. After the addition, continue stirring at 0 Celsius for 30 minutes, and then remove the ice bath. Then stir for an additional 3 hours. Afterwards, filter the reaction mixture to remove 26 grams of triethylamine hydrochloride precipitate, and then place the reaction mixture into a distillation apparatus and distill off the acetonitrile at 82 Celsius until no more acetonitrile is collected in the receiver flask (the distillation may have to be temporarily stopped several times in order to filter-off precipitated product). When all the acetonitrile has been removed, remove the heat source, and then collect the product of oil and solid. Then cool it to room temperature (vacuum filter or air dry any filtered-off product obtained during the distillation, and then add it to the oil and solid). Then mix this yellow oil and solid with 30 milliliters of acetonitrile, and then pour the whole mixture through a column of silica gel (use 80 grams, EM grade 62). Collect the liquid passing through the column into a suitable flask. After which, prepare a solution containing 10% acetonitrile in benzene by dissolving 10 milliliters of acetonitrile into 100 milliliters of benzene. Then divide this benzene solution into three fractions (36 milliliters each fraction), and pass each fraction separately through the column only once. Collect the liquid passing through the column into the same flask for all three fractions. Afterwards, place the contents of the flask into a distillation apparatus, and distill at 82 Celsius until only a solid residue remains (the distillation may have to be temporarily stopped several times in order to filter-off precipitated product). If a rotary evaporator is available, evaporate-off the solvent under vacuum. When all the solvent has been removed, remove the heat source, and then collect the product. Then cool it to room temperature (vacuum filter or air dry any filtered-off product obtained during the distillation, and then add it to the rest of the product). Then mix this residue with 30 milliliters of 95% ethanol, and stir the mixture for about ten minutes. After stirring for about ten minutes, filter the liquid to collect the product. Then wash the product with 300 milliliters of cold water, and then vacuum dry or air dry. The result will be 1.6 grams of DDD, which will have a melting point of 198 to 203 Celsius (with decomposition).

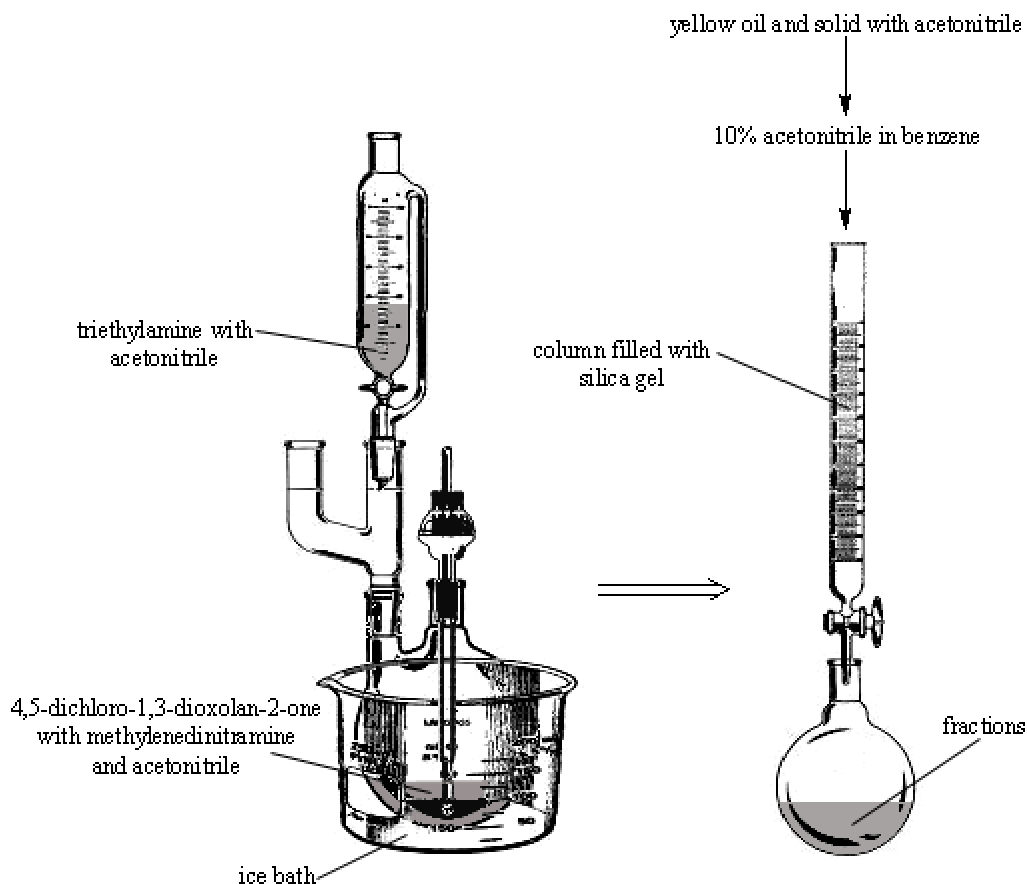

Figure 038. Setup for DDD preparation. Left illustration: Reaction apparatus. Right illustration: Apparatus with column to remove impurities by absorption onto silica gel.

Notes:

T-NAT DDD composite explosive

Place 200 grams of toluene into a beaker, and heat to 80 Celsius. Then add 4056 grams of DDD, and rapidly stir the mixture for 1 hour. In another flask, place 210 grams of a polymeric surfactant and 4.2 grams of ethylene glycol to form a dispersion (fuel phase), and then heat the mixture to 80 Celsius for 20 minutes while stirring. After which, slowly add the toluene/DDD mixture to the heated dispersion mixture over a period of 2 hours while stirring the dispersion mixture and maintaining its temperature at 80 Celsius. After all the toluene/DDD mixture is added, rapidly blend the mixture for 2 hours at 80 Celsius. Afterwards, reduce heat to 65 Celsius, and then continue blending for 2 hours. After which, stop heating, and then filter the mass to remove any loose liquids. Then press the filtered mass into any desirable mold, container, bomb casing, or warhead casing and then cure for several days at room temperature. Commercial & Industrial note: Part or parts of this laboratory process may be protected by international, and/or commercial/industrial processes. Before using this process to legally manufacture the mentioned explosive, with intent to sell, consult any protected commercial or industrial processes related to, similar to, or additional to, the process discussed in this procedure. This process may be used to legally prepare the mentioned explosive for laboratory, educational, or research purposes.

6-03. TEX. 4,10-dinitro-2,6,8-12-tetraoxa-4,10-diazatetracyclo-[5.5.0.05,903,11]-dodecane

CHAPTER 6: THE PREPARATION OF AZA/OXA NITRAMINES

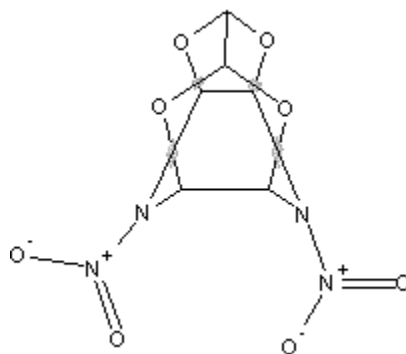

TEX

TEX forms white to slightly yellow crystals, which may be colored brown to other various colors due to impurities. TEX is a moderately powerful explosive with definite stability. It can be used effectively in rocket propellants, high performance gun propellants, or high explosive compositions.

Molecular weight: 261.126	Flammability: Burns with smoky flame
Detonating velocity: Similar to TNT	Toxicity: Mild
Sensitivity: Very low (requires blasting cap)	Classification: Secondary explosive
Stability: Very good	Overall value (as secondary explosive): Very high

Procedure 6-03A: Preparation of TEX

Materials:	1. 1350 milliliters of 98% sulfuric acid
	2. 1350 milliliters of 30% fuming sulfuric acid
	3. 4500 milliliters 90% nitric acid
	4. 1236 grams THDFP
	5. 184 grams urea
	6. 1000 milliliters of 5% baking soda

Summary: Tex is made by treating a THDFP/urea mixture with a nitrating acid mixture in the presence of fuming sulfuric acid. The fuming sulfuric acid removes the water formed during the reaction. After the reaction, the mixture is treated with ice, and shortly after, the precipitated product is filtered-off, washed, and dried. Commercial & Industrial note: For related, or similar information, see Application No. 362,083, July 28, 1999, by Cordant Technologies Inc., to Robert B. Wardle, Logan, UT, Robert M. Hajik, Willard, UT, Jerald C. Hinshaw, Ogden, UT, and Thomas K. Highsmith, Ogden, UT. Part or parts of this laboratory process may be protected by international, and/or commercial/industrial processes. Before using this process to legally manufacture the mentioned explosive, with intent to sell, consult any protected commercial or industrial processes related to, similar to, or additional to, the process discussed in this procedure. This process may be used to legally prepare the mentioned explosive for laboratory, educational, or research purposes.

Hazards: Warning! Wear gloves and use proper ventilation when handling 90% nitric acid and 30% fuming sulfuric acid. These acids are highly toxic and corrosive, and they evolve toxic fumes. Use caution.

CHAPTER 6: THE PREPARATION OF AZA/OXA NITRAMINES

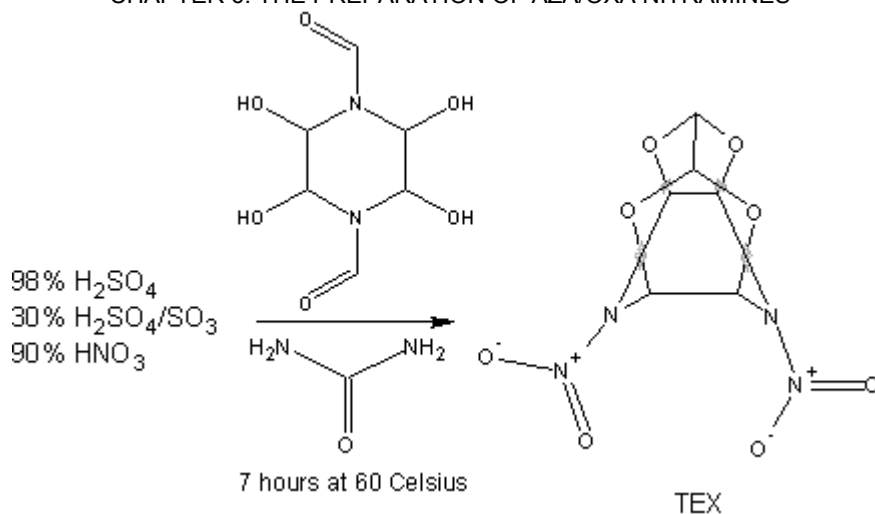

Reaction Equation

Procedure: Note: This procedure uses an excessive amount of 90% nitric acid. It should be noted that this quantity of acid is necessary to carryout the reaction for the product at hand. It should be noted that other nitro compounds are produced during this procedure. These compounds can be isolated using various techniques, but these techniques will not be discussed here as they deviate from the procedure.

Preparing the THDFP/urea mixture

Prepare the THDFP/urea mixture by thoroughly blending 1236 grams of THDFP with 184 grams of urea for thirty minutes, and then dry the blended mixture overnight at 50 Celsius. After heating overnight, allow the mixture to cool to room temperature prior to use.

Preparation of TEX

Into a 10-liter, 3-neck flask equipped with a stirrer, condenser, and thermometer, place 4500 milliliters of 90% nitric acid. Thereafter, add 1350 milliliters of 98% sulfuric acid, followed by 1350 milliliters of 30% fuming sulfuric acid, and then constantly stir the mixture for ten minutes. The temperature of the acid mixture will increase to 60 Celsius. After adding the 30% sulfuric acid, slowly add the THDFP/urea mixture, portion wise (about 60 grams at a time), over a period of 14 hours while maintaining the reaction temperature at 60 Celsius. Then continue stirring after the final addition of the THDFP/urea mixture for 2 hours. After stirring for 2 hours, pour the entire reaction mixture onto 5000 grams of ice contained in a large beaker. Wait for most of the ice to melt and then filter-off the precipitated product. Then wash the product with 1000 milliliters of cold water, then 1000 milliliters of 5% baking soda solution, and then with four 500-milliliter portions of cold water. After the washings, vacuum dry or air-dry the product. The dry product should weigh 331 grams.

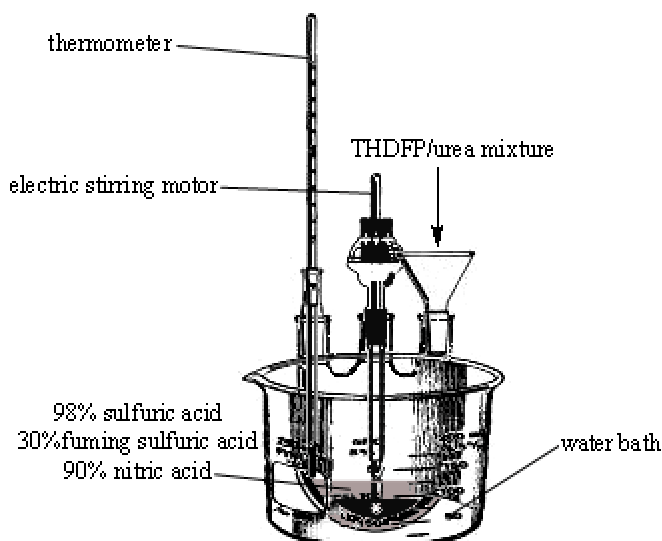
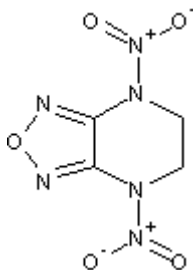

Figure 039. Apparatus for the preparation of TEX.

Notes:

6-04. DNFA-P. 1,4-dinitrofurazano[3,4-b]piperazine



DNFA-P

Uses: Rocket propellants, gun propellants, fireworks, and explosives compositions. May be used as a smoke suppressing agent in high performance rocket propellants.

Molecular weight: 216.113	Flammability: Burns, but may flash when ignited
Detonating velocity: Similar to DDD	Toxicity: Mild
Sensitivity: Very low (requires blasting cap)	Classification: Secondary explosive
Stability: Very good	Overall value (as secondary explosive): High

Procedure 6-04A: Preparation of DNFA-P

Materials:	1. 278 grams hydroxylamine hydrochloride
	2. 290 grams of 40% glyoxal
	3. 212 grams sodium carbonate
	4. 400 milliliters 95% ethanol
	5. 70 grams chlorine gas
	6. 200 milliliters chloroform
	7. 800 milliliters methanol
	8. 24 grams ethylenediamine

CHAPTER 6: THE PREPARATION OF AZA/OXA NITRAMINES

	9. 40 milliliters ethylene glycol
	10. 6.4 grams sodium hydroxide
	11. 28 milliliters trifluoroacetic anhydride
	12. 12 milliliters 99% nitric acid
	13. 140 milliliters of acetone

Summary: DNFA-P, 1,4-dinitrofurazano[3,4-b]piperazine is prepared by reacting glyoxal with hydroxylamine chloride to yield glyoxime. Glyoxime is then treated with chlorine to produce dichloroglyoxime. The resulting substance is then treated with ethylenediamine to produce 2,3-dioximinopiperazine. 2,3-dioximinopiperazine is converted to furazano[3,4-b]piperazine by reaction with sodium hydroxide. The furazano[3,4-b]piperazine is treated with trifluoroacetic anhydride and 99% nitric acid at -30 Celsius to yield DNFA-P. Commercial & Industrial note: For related, or similar information, see Application No. 600,708, April 16, 1984, by The United States Navy, to Rodney L. Willer, Ridgecrest, CA. Part or parts of this laboratory process may be protected by international, and/or commercial/industrial processes. Before using this process to legally manufacture the mentioned explosive, with intent to sell, consult any protected commercial or industrial processes related to, similar to, or additional to, the process discussed in this procedure. This process may be used to legally prepare the mentioned explosive for laboratory, educational, or research purposes.

Hazards: Wear gloves and use proper ventilation when handling 99% nitric acid. 99% nitric acid is a highly corrosive and poisonous liquid, which evolve highly poisonous fumes of nitrogen oxides. Use great care. Use proper ventilation when handling chlorine gas. Chlorine gas is toxic and is a strong irritant. Wear gloves when handling trifluoroacetic anhydride, which can cause skin burns.

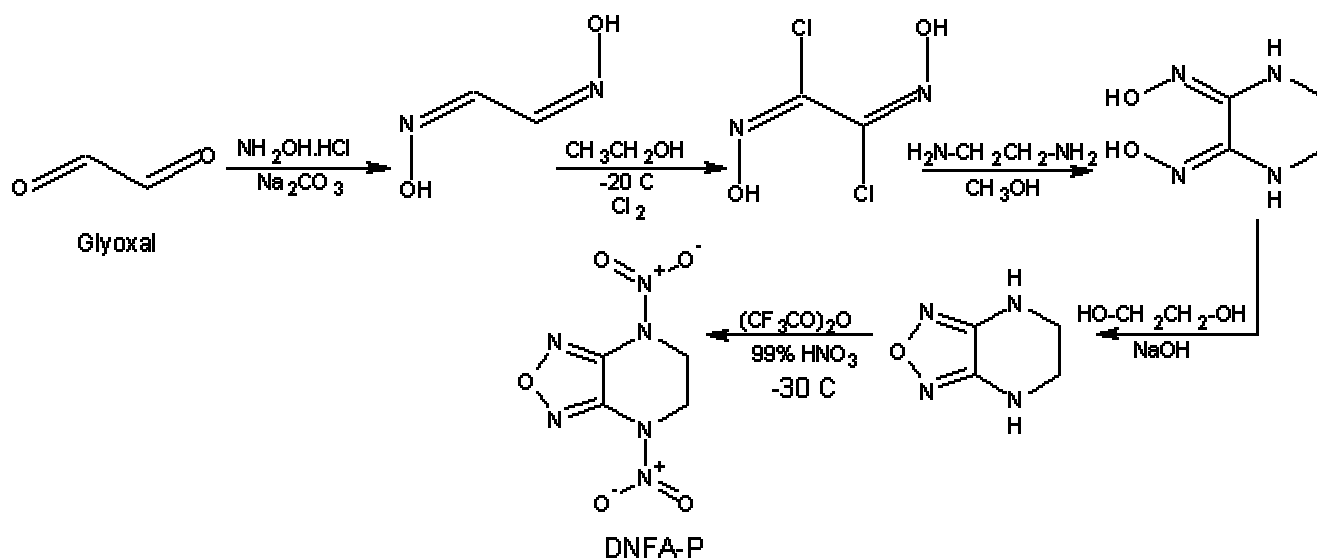
Procedure:

Step 1: Preparation of glyoxime

To a 2-liter Erlenmeyer flask, add 278 grams of hydroxylamine hydrochloride and 200 milliliters of water, and then stir the solution to dissolve the hydroxylamine hydrochloride. When the hydroxylamine hydrochloride is dissolved, add 290 grams of a 40% glyoxal water solution while stirring the hydroxylamine solution. After addition of the glyoxal solution, stir the mixture while slowly adding, in small portions, 212 grams of sodium carbonate over a period of 4 hours. After the addition of the sodium carbonate, stir the reaction mixture at room temperature for 2 hours. After 2 hours, heat the mixture in a reflux apparatus at 100 Celsius to dissolve the crude product. After the crude product dissolves, remove the heat source, and allow the mixture to cool to room temperature. When room temperature is achieved, cool the mixture to 0 Celsius using an ice bath, and then keep the mixture at 0 Celsius for 1 hour. Afterwards, filter-off the glyoxime product, wash with 400 milliliters of water, and then vacuum dry or air dry. The yield will be about 140 grams with a melting point of 172 Celsius.

Step 2: Preparation of dichloroglyoxime

CHAPTER 6: THE PREPARATION OF AZA/OXA NITRAMINES

Place 35 grams of glyoxime (prepared in step 1) and 400 milliliters of 95% ethanol into a 2-liter three-neck flask equipped with a stirrer, and gas inlet tube. Then cool the mixture to -20 Celsius by means of a dry ice/acetone bath. When the temperature of the mixture reaches -20 Celsius, stir the mixture while bubbling 70 grams of chlorine gas into the mixture over a period of 1 hour, and maintain the reaction mixture at -20 Celsius during the addition. After the addition of the chlorine gas, stir the mixture for 40 additional minutes at -20 Celsius. After 40 minutes, remove the dry ice/acetone bath, and then place the reaction mixture into a shallow pan with a high surface area. Then allow the solvent to evaporate (heating the mixture may result in damage to the product). After the solvent has evaporated, collect the product, and then slurry it with chloroform by adding 200 milliliters of chloroform. Then stir this slurry for about ten minutes, and then filter-off the product. After which, vacuum dry or air-dry the product. The product will weigh 60.4 grams.

Step 3: Preparation of 2,3-dioximinopiperazine

Place 31.4 grams of dichloroglyoxime (prepared in step 2) and 800 milliliters of methanol into a two-liter flask, and then cool the mixture to 5 Celsius by means of an ice bath. When the temperature of the mixture reaches 5 Celsius, prepare a solution by dissolving 24 grams of ethylenediamine into 60 milliliters of methanol. Then add this solution (all at once) to the dichloroglyoxime solution while stirring the dichloroglyoxime solution, and maintain its temperature at 5 Celsius. After the rapid addition, stir the reaction mixture for 20 minutes at 5 Celsius. After 20 minutes, remove the ice bath, and then place the reaction mixture into a distillation apparatus. Then distill the mixture at 64 Celsius until dry solid remains. When dry solid remains, remove the heat source, and allow the dry solid to cool to room temperature. Thereafter, collect the dry solid, and then slurry it by adding 40 milliliters of water. After which, filter-off the product, and then wash the product with 40 milliliters of methanol, 3 times using the same 40-milliliter portion, and then vacuum dry or air-dry the product. The washed dry product will weigh 22 grams.

Step 4: Preparation of furazano[3,4-b]piperazine

Place 40 milliliters of ethylene glycol, and 6.4 grams of sodium hydroxide into a flask. Then heat this mixture to 150 Celsius while stirring. When the sodium hydroxide has dissolved, add 22 grams of 2,3-dioximopiperazine (prepared in step 3) in small portions over a 6-minute period while maintaining the reaction mixture temperature at 150 Celsius. After addition, heat the reaction mixture for 40 minutes at 150 Celsius while stirring. After 40 minutes, remove the heat source, and allow the reaction mixture to cool to room temperature. After which, add 40 milliliters of water, and then cool the reaction mixture to 0 Celsius using an ice bath. Then stir the reaction mixture at 0 Celsius for 2 hours. After 2 hours, filter-off the product, and then vacuum dry or air-dry the product. The product will be light yellow needles with a melting point of 153 Celsius, and will weigh 10.44 grams.

Step 5: Preparation of 1,4-dinitrofurazano[3,4-b]piperazine

Place 28 milliliters of trifluoroacetic anhydride into a flask. Then cool the trifluoroacetic anhydride to -30 Celsius using a dry ice/acetone bath. When the temperature of the liquid reaches -30 Celsius, add 12 milliliters of 99% nitric acid, drop wise, over a 4-minute period while stirring the trifluoroacetic anhydride and keeping the temperature at -30 Celsius. After the addition of the 99% nitric acid, remove the dry ice/acetone bath, and allow the mixture to warm to 0 Celsius. When 0 Celsius is obtained, place the mixture back into the dry ice/acetone bath, and cool to -30 Celsius. When the reaction mixture reaches -30 Celsius, add 5.04 grams of furazano[3,4-b]piperazine (prepared in step 4) in small portions over a 10-minute period. After the addition, remove the dry ice/acetone bath, and allow the reaction mixture to warm to room temperature. Afterwards, place the reaction mixture into a shallow pan with a high surface area, and allow the solvent to evaporate (blowing air over the liquids surface using a small cooling fan is a means for speeding up the evaporation). After all liquids have been evaporated, collect the dry product, and then recrystallize the dry product from a solvent mixture prepared by adding 140 milliliters of acetone to 140 milliliters of water. After recrystallization, vacuum dry or air-dry the product. The product, 1,4-dinitrofurazano[3,4-b]piperazine, will be in the form of platelets with a melting point of 122 Celsius (with decomposition).

Notes:

CHAPTER 7: THE PREPARATION OF CYCLIC NITRAMINES

RDX, SOLEX, HMX, NINHT, TNAD, DPT

7-01. RDX. *Cyclonite; Hexahydro-1,3,5-trinitro-1,3,5-triazine; 1,3,5-trinitrohexahydro-s-triazine; cyclotrimethylenetrinitramine*

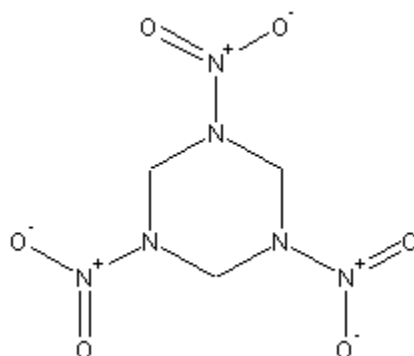

RDX

RDX forms orthorhombic crystals with a melting point of 206 Celsius. 1 Gram dissolves in 25 milliliters of acetone, but its solubility in alcohol, ether, ethyl acetate, and glacial acetic acid is even less. It is insoluble in water, carbon tetrachloride, and carbon disulfide. RDX is one of the most important military explosives known to man. It is highly versatile, being resistant to heat, shock and percussion, and is capable of being alloyed with many different secondary explosives. RDX is very well known in several of the most important explosives compositions. These compositions include: semtex, C4, and composition B, all of which are widely used in military operations. RDX is by far one of the most important explosives in occurrence, and it is manufactured on an industrial scale.

Molecular weight: 222.117	Flammability: Burns with smoky flame
Detonating velocity: 8700	Toxicity: Mild
Sensitivity: Very low (requires primary explosive)	Classification: Secondary explosive
Stability: Very good	Overall value (as secondary explosive): Extremely high

Procedure 7-01A: Preparation of RDX

Materials:	1. 22.6 grams DAPT
	2. 13.6 grams glacial acetic acid
	3. 21 grams ammonium nitrate
	4. 26.2 grams of 70% nitric Acid
	5. 60 grams acetic anhydride

Summary: RDX is prepared by reacting DAPT with ammonium nitrate and acetic anhydride. Nitric acid is added to acidify the reaction mixture. The RDX later precipitates, filtered off, washed with water, and then dried. Commercial & Industrial note: For related, or similar information, see Application No. 936,375, August 28, 1992, by The United States Army, to William J. Lukasavage, Las Vegas, NV, Steven Nicolich, Saddle Brook, NJ, Norman Slagg, Wayne, NJ. Part or parts of this laboratory process may be protected by international, and/or commercial/industrial processes. Before using this process to legally manufacture the mentioned explosive, with intent to sell, consult any protected commercial or industrial processes related to, similar to, or additional to, the process discussed in this procedure. This process may be used to legally prepare the mentioned explosive for laboratory, educational, or research purposes.

Hazards: Caution! Glacial acetic acid, 70% nitric acid, and acetic anhydride can cause skin burns. Wear gloves when handling and use proper ventilation. Wear gloves when handling acetic anhydride, and glacial acetic acid; both of which can produce skin irritation. Wear gloves when handling 70% nitric acid; causes skin irritation, and yellowing.

CHAPTER 7: THE PREPARATION OF CYCLIC NITRAMINES

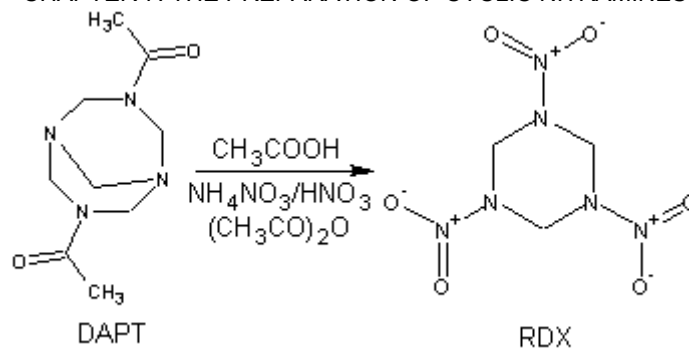

Reaction Equation

Procedure: Into a 200-milliliter beaker add 13.6 grams glacial acetic acid, and then add and dissolve 22.6 grams of DAPT. Afterwards, pour the contents of the 200-milliliter beaker into a round bottom flask and then assemble the apparatus illustrated in figure 040. After which, prepare a solution by dissolving 21 grams of ammonium nitrate into 26.2 grams of 70% nitric acid, and then place this solution into one of the dropping funnels attached to the round bottom flask. Then add 60 grams of acetic anhydride to the second dropping funnel. Then slowly add the two solutions from the dropping funnels, drop wise. During the additions keep the reaction temperature below 68 Celsius (this is done by slow addition of the two liquids). If the temperature of the reaction mixture goes above 68 Celsius, stop the additions and allow the mixture to cool in a cold water bath (Note: The addition sequence is started with the nitric acid/ammonium nitrate solution and is followed by the acetic anhydride. In other words, the nitric acid/nitrate solution is added in a small portion first. After a couple of seconds some of the acetic anhydride is added. This cycle of addition of reactants is continued until both liquids have been added to the reaction mixture). An initial unknown precipitate forms almost from the first addition of the nitric acid/ammonium nitrate solution. The precipitate will then re-dissolve, and the solution clears. The solution remains clear until about two-thirds of the additional reactants are added. A second precipitate now forms which is RDX. As the additions proceed, the RDX precipitate will become noticeably greater. After the addition of the nitric acid/ammonium nitrate solution and the acetic anhydride, place the reaction mixture into a cold water bath and cool to room temperature. Afterwards, stir the mixture for 20 minutes at room temperature and then filter-off the precipitated RDX product, wash with 500 milliliters of cold water, and then vacuum dry or air dry. The dried RDX will have a high purity.

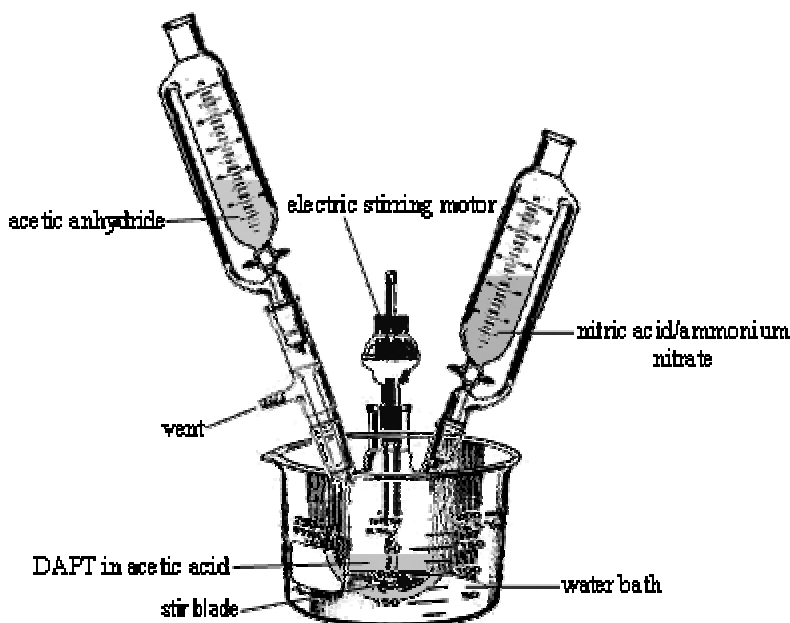

Figure 040. Apparatus with two addition funnels for RDX preparation.

Notes:

Procedure 7-01B: Preparation of RDX

Materials:	1. 55.2 grams Propionitrile
	2. 1300 milligrams (1 drop) 98% Sulfuric acid
	3. 30 grams trioxane
	4. 600 milliliters of 99% Nitric acid

Summary: In this procedure, propionitrile and sulfuric acid are heated together, and then a solution of trioxane (formaldehyde trimer) in propionitrile is slowly added a short time later. Shortly after the addition, a triazine compound is formed. This triazine compound is only an intermediate and need not be isolated. The triazine slurry is then added to ten times its volume of 99% nitric acid. The resulting mixture is then cooled, heated, and then cooled again. The mixture is then drowned into 5 times its volume of water. The RDX then precipitates in high purity. Commercial & Industrial note: For related, or similar information, see Application No. 522,153, November 8, 1974, by The United States Army, to Joseph A. Meredith, Bluff City, TN. Part or parts of this laboratory process may be protected by international, and/or commercial/industrial processes. Before using this process to legally manufacture the mentioned explosive, with intent to sell, consult any protected commercial or industrial processes related to, similar to, or additional to, the process discussed in this procedure. This process may be used to legally prepare the mentioned explosive for laboratory, educational, or research purposes.

Hazards: Use great care when handling 99% nitric acid; produces poisonous reddish-brown fumes of nitrogen oxides; use maximum ventilation.

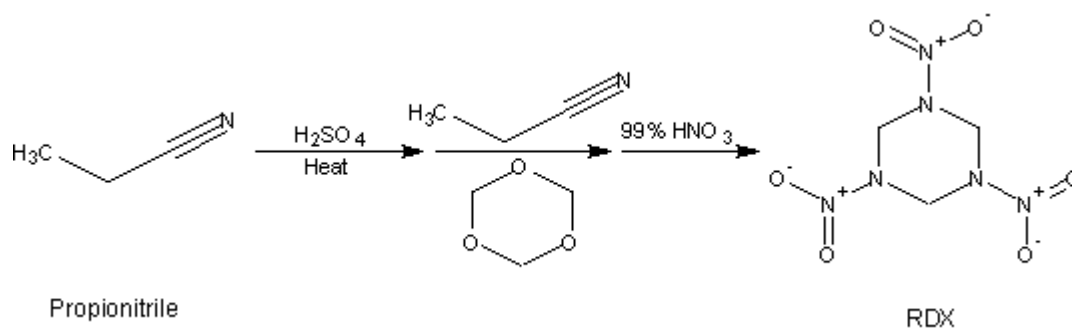

Reaction equation

Procedure: Note: This procedure uses an excessive amount of 99% nitric acid to properly carry out the reaction. This excessive amount of acid can be recovered by treating the reaction mixture (after complete removal of the product) with methylene chloride to recover the nitric acid. Prior to this action, a small amount of sulfuric acid should be added to the reaction mixture. Afterwards, the reaction mixture should be extracted with several volumes of methylene chloride. These combined volumes can then be carefully distilled to recover the nitric acid of 99% purity (see nitric acid, 90% and 99% respectively).

Add 27.6 grams of propionitrile and 2-drops of 98% sulfuric acid into a round bottom flask and then assemble the apparatus illustrated in figure 041. Then carefully heat this propionitrile mixture at 95 Celsius for 1 hour. After 1 hour, continue heating while preparing a solution by mixing 30 grams of trioxane with 27.6 grams of propionitrile. After which slowly add this mixture drop wise to the heated propionitrile/sulfuric acid mixture while stirring the propionitrile/sulfuric acid mixture, and maintaining its temperature at 95 Celsius. After the addition of the trioxane mixture, remove the heat source, and allow the reaction mixture to cool to room temperature. Then place 600 milliliters of 99% nitric acid into a flask and then cool in an ice bath to 0 Celsius. When the 99% nitric acid reaches 0 Celsius, slowly add the reaction mixture (which should now be a slurry) into the 99% nitric acid over a period of 2 hours, while stirring the 99% nitric acid and maintaining its temperature at 0 Celsius. After the addition, continue to stir the mixture at 0 Celsius for an additional 30 minutes. Next, remove the reaction mixture from the ice bath, and then slowly heat the reaction mixture to 60 Celsius, and then heat at 60 Celsius for 2 hours. After 2 hours, remove the heat source, and allow the reaction mixture to cool to room temperature. Afterwards, add the entire reaction mixture into 1500 milliliters of cold water. Finally, filter-off the precipitated RDX product, wash with 500 milliliters of cold water, and then vacuum dry or air-dry. The result will be high purity RDX.

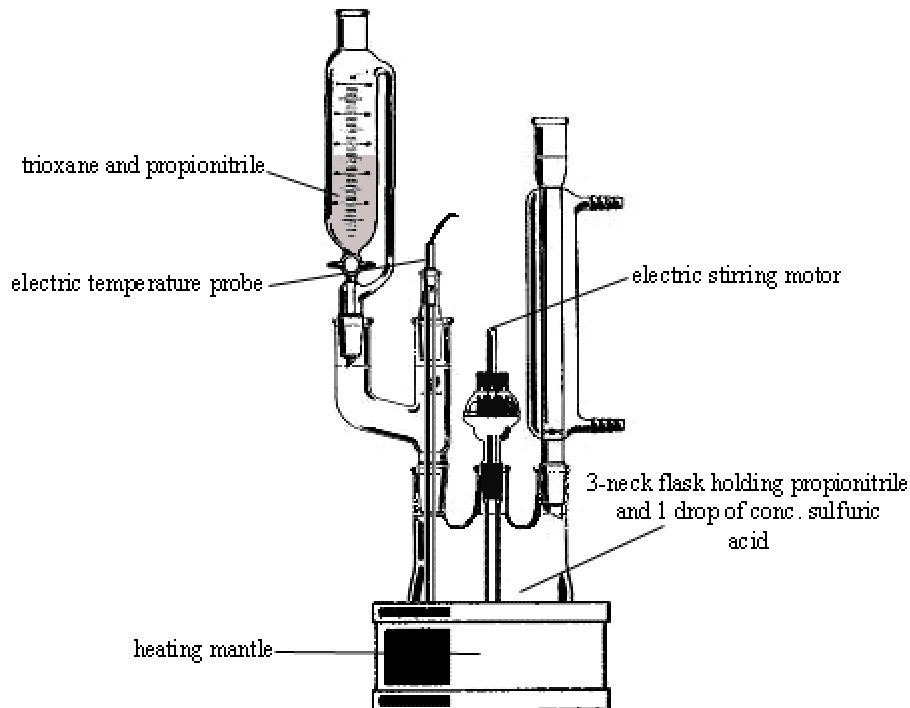

Figure 041. Apparatus with addition funnel.

Notes:

Procedure 7-01C: Preparation of RDX

Materials:	1. 20 grams hexamine
	2. 220 grams 99% nitric acid
	3. 14 grams 70% nitric acid
	4. 2 grams sodium nitrite

Summary: RDX can be prepared directly from hexamine by treatment with 99% nitric acid, followed by treatment with 70% nitric acid at 70 Celsius. The reaction mixture is then cooled, and the precipitated RDX is filtered, washed, and dried.

Commercial & Industrial note: Part or parts of this laboratory process may be protected by international, and/or commercial/industrial processes. Before using this process to legally manufacture the mentioned explosive, with intent to sell, consult any protected commercial or industrial processes related to, similar to, or additional to, the process discussed in this procedure. This process may be used to legally prepare the mentioned explosive for laboratory, educational, or research purposes.

Hazards: Use great care when handling 99% nitric acid; produces poisonous reddish-brown fumes of nitrogen oxides; use maximum ventilation. Wear gloves when handling 70% nitric acid; causes skin irritation, and yellowing.

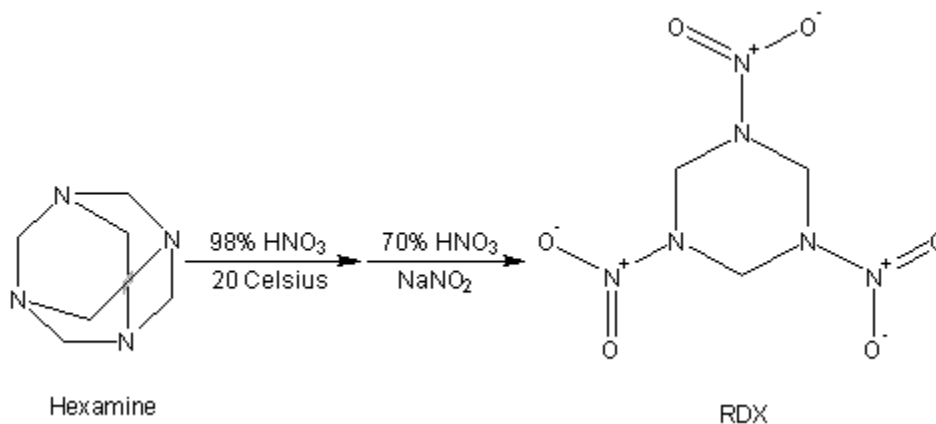
*Reaction Equation*

Procedure: Note: This procedure uses an excessive amount of 99% nitric acid to properly carry out the reaction. This excessive amount of acid can be recovered by treating the reaction mixture (after complete removal of the product) with methylene chloride to recover the nitric acid. Prior to this action, a small amount of sulfuric acid should be added to the reaction mixture. Afterwards, the reaction mixture should be extracted with several volumes of methylene chloride. These combined volumes can then be carefully distilled to recover the nitric acid of 99% purity (see nitric acid, 90% and 99% respectively).

Place 220 grams of 99% nitric acid into a beaker, and then cool to 10 Celsius by means of a cold water bath. When the temperature of the 99% nitric acid reaches about 10 Celsius, slowly add 20 grams of hexamine while stirring the 99% nitric acid and maintaining its temperature at about 10 Celsius. After the addition of the hexamine, maintain the reaction mixture temperature at 20 Celsius for 40 minutes with constant stirring. Then place 14 grams of 70% nitric acid and 2 grams of sodium nitrite into a flask and heat to 70 Celsius. When the temperature reaches 70 Celsius, slowly add the reaction mixture while maintaining the temperature of the 70% nitric acid mixture at 70 Celsius and stirring. After the addition of the reaction mixture, continue heating at 70 Celsius for about 40 minutes. After which, remove the heat source, and allow the reaction mixture to cool to room temperature. Then place the reaction mixture into an ice bath, and cool to about 5 Celsius. Finally, add the entire reaction mixture to 500 milliliters of cold water and then filter-off the precipitated RDX product, wash with 200 milliliters of water, and then vacuum dry or air-dry.

Notes:

Procedure 7-01D: Preparation of RDX

Materials:	1. 20 grams 1,3,5-tripropionylhexahydro-s-triazine
	2. 400 milliliters 99% nitric acid

Summary: RDX is conveniently prepared by adding 1,3,5-tripropionylhexahydro-s-triazine to 99% nitric acid at moderate temperature. Thereafter, the reaction mixture is stirred at 70 Celsius for a short period, and the RDX precipitate then collected by filtration. The precipitate is then washed and dried. Commercial & Industrial note: For related, or similar information, see Serial No. 260,068, February 20th 1963, by Dupont De Nemours Inc., to Donald N. Thatcher, Pitman, NJ. Part or parts of this laboratory process may be protected by international, and/or commercial/industrial processes. Before using this process to legally manufacture the mentioned explosive, with intent to sell, consult any protected commercial or industrial processes related to, similar to, or additional to, the process discussed in this procedure. This process may be used to legally prepare the mentioned explosive for laboratory, educational, or research purposes.

Hazards: Use great care when handling 99% nitric acid; produces poisonous reddish-brown fumes of nitrogen oxides; use maximum ventilation.

CHAPTER 7: THE PREPARATION OF CYCLIC NITRAMINES

inches wide, by 5 to 11 inches long, and after the explosive mixture has cured, remove the mold or container, and then warp the explosive in paper, plastic, or cardboard. The molten mixture can also be poured into shallow pans and allowed to cool to form non-flexible sheet explosive. Requires blasting cap or detonator for initiation. Commercial & Industrial note: Part or parts of this laboratory process may be protected by international, and/or commercial/industrial processes. Before using this process to legally manufacture the mentioned explosive, with intent to sell, consult any protected commercial or industrial processes related to, similar to, or additional to, the process discussed in this procedure. This process may be used to legally prepare the mentioned explosive for laboratory, educational, or research purposes.

RDX explosive composition

Step 1: Preparation of RDX coated with PVP.

Dissolve 100 milligrams of polyvinyl pyrrolidone (molecular weight: 90,000) into 60 milliliters of water, and heat the mixture to 90 Celsius. Then add 95 grams of RDX (with an average particle size of about 20 microns) while stirring the water solution and maintaining its temperature at 90 Celsius. After the addition of the RDX, continue heating and stirring at 90 Celsius in an open vessel to evaporate most of the water. When most of the water has been evaporated (to the point when only a wet paste remains), remove the heat source and allow the moist paste to cool to room temperature.

Step 2: Preparation of a RDX/PVP/AP explosive Powder.

To the moist paste (obtained in step 1), add 5 grams of ammonium picrate (with an average particle size of 4 microns), and 40 grams of water. Then heat the mixture to 90 Celsius with stirring, and continue heating and stirring until most of the water has evaporated (until only a moist paste remains). When most of the water has evaporated, remove the heat source and then place the moist paste into a shallow pan and allow it to stand until dry.

Step 3: Preparation of an RDX/PVP/AP powder coated with petrolatum.

Dissolve 600 milligrams of petrolatum into 16.6 grams of methylene chloride. Afterwards, add 20 grams of the RDX/AP explosive powder (obtained in step 2) while stirring the methylene chloride solution. After the addition of the RDX/AP explosive powder, continue stirring at room temperature for 20 minutes, and then stop stirring and allow the methylene chloride to evaporate at room temperature. The resulting dry mixture will be a free-flowing. Requires blasting cap or detonator for initiation. Note: The petrolatum employed is Petrolatum, FSN6505-133-8025, marketed by Purelene White Oils, Inc., Paterson, N.J. It corresponds to Merck Index, Ninth Edition, No. 6970, Petrolatum. Commercial & Industrial note: For related, or similar information, see Application No. 050,378, June 20, 1979, by The United States Army, to H. William Voigt, Jr., Stanhope, NJ. Part or parts of this laboratory process may be protected by international, and/or commercial/industrial processes. Before using this process to legally manufacture the mentioned explosive, with intent to sell, consult any protected commercial or industrial processes related to, similar to, or additional to, the process discussed in this procedure. This process may be used to legally prepare the mentioned explosive for laboratory, educational, or research purposes.

Explosives Standard "PBX" RDX Plastic bonded explosive

Add 180 grams of RDX to 1000 milliliters of water, and mix thoroughly to form a slurry. Then prepare a bulk solution of oxazolin wax by dissolving 30 grams of oxazolin wax into 2 liters of 1-chloroethane, and then add 3 milliliters of this bulk solution to the RDX slurry. After which, heat the RDX slurry to 90 Celsius and manually blend for 10 minutes. Then prepare a solution by dissolving 17 grams polystyrene and 3 grams of dioctylphthalate into 100 grams of methyl ethyl ketone, and then add this solution to the RDX slurry mixture. After the addition, continue stirring the slurry mixture at 90 Celsius, and allow the methyl ethyl ketone to evaporate off. After the methyl ethyl ketone is removed by evaporation, remove the heat source, and allow the mixture to cool to room temperature. Afterwards, filter-off the granulated PBX explosive product, and then place the granules on a tray and allow them to dry for several days. When the explosive granules are dried, they can be used as granules, or pressed under high pressure into any desirable mold, container, bomb casing, or warhead casing. For demolition purposes, remove the pressed explosive from the container and then wrap the explosive in plastic, paper, or cardboard. Requires blasting cap or detonator for initiation. Commercial & Industrial note: Part or parts of this laboratory process may be protected by international, and/or commercial/industrial processes. Before using this process to legally manufacture the mentioned explosive, with intent to sell, consult any protected commercial or industrial processes related to, similar to, or additional to, the process discussed in this procedure. This process may be used to legally prepare the mentioned explosive for laboratory, educational, or research purposes.

RDX high performance rocket propellant

CHAPTER 7: THE PREPARATION OF CYCLIC NITRAMINES

Mix 1600 grams of a hydroxyl terminated polybutadiene (HTPB, R-45 M, trademark, produced by Alco Co.) with 160 grams of dioctyl adipate (DOA), and then manually blend the mixture rapidly for 1 hour. Then add 32 grams of triethanolamine (TEA) and then 32 grams of a polybutadiene (trademark, produced by Nippon Zeon Co., Ltd.) and rapidly blend the mixture for 2 hours. After 2 hours, add 176 grams of a curing agent called isophorone diisocyanate (IPDI, produced by VEBA Chemie Co.), and thoroughly blend the mixture for 30 minutes. After which, add 8000 grams of RDX and then heat the mixture to 60 Celsius and blend rapidly for 2 hours. After 2 hours, cast the slurry explosive mixture into any desirable mold, container, or rocket motor and then cure in an oven at 60 Celsius for 7 days. Do not use a blasting cap or detonator for initiation.

Commercial & Industrial note: For related, or similar information, see Application No. 308,770, October 5, 1981, by Nippon Oil and Fats Co., Ltd., Tokyo, JP, to Kunio Hasegawa, Aichi, JP, Michinori Takizuka, Handa, JP. Part or parts of this laboratory process may be protected by international, and/or commercial/industrial processes. Before using this process to legally manufacture the mentioned explosive, with intent to sell, consult any protected commercial or industrial processes related to, similar to, or additional to, the process discussed in this procedure. This process may be used to legally prepare the mentioned explosive for laboratory, educational, or research purposes.

Standard Explosives "C-3" RDX plastic bonded explosive composition

Into a beaker place 285 grams of an aqueous polyurethane dispersion, 6 grams of polyethylene glycol, 1861 grams of RDX, and 207 grams of water, and then manually blend the mixture for 2 hours at room temperature. After mixing, place the mixture into a shallow pan, and allow the mixture to dry at 50 Celsius for 24 hours. After the mixture has dried, press the explosive mixture into any mold, container, bomb casing, or warhead casing under high pressure. For demolitions use, remove the plastic explosive from the container or mold after pressing, and then wrap in paper, plastic, or cardboard. For demolitions purposes, the molds or containers should be rectangular in shape, and usually 2 inches wide by 5 to 11 inches long. Afterwards, the pressed explosive can be shaped or molded by hand if need be. Requires blasting cap or detonator for initiation.

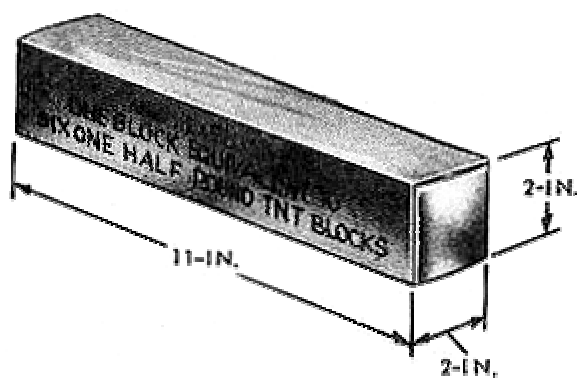

Figure 042. Illustration of a US Army C-3 military demolition explosives block. See TM 43-0001-38, June 1981, for additional information on military C3.

Standard Explosives "C-4" RDX plastic bonded explosive composition

Place 602 grams of RDX into a beaker and then add 15.3 grams of polypropylene glycol and then 80 milliliters of water, and then rapidly blend the mixture for 1 hour. After 1 hour, place the mixture into a shallow pan, and then dry the mixture at 50 Celsius for 24 hours. After the mixture is dried, press into sheets under high pressure, or press into any desirable mold or container under high pressure. For demolitions use, remove the pressed explosive from the container and then wrap in paper, plastic or cardboard. The explosive should be pressed into rectangular containers or molds of 2 inches width by 5 to 11 inches length. Requires blasting cap or detonator for initiation.



Figure 043. Illustration of a US Army C-4 military demolition explosive block. See TM 43-0001-38, June 1981, for additional information on military C4.

Explosive munitions of RDX

Standard military/commercial electric blasting caps are essential to initiate high explosives and their explosive compositions. In the following electric blasting caps, lead wires of copper, enter the blasting cap, and form a bridge which contacts an ignition charge, made of a heat sensitive priming mixture. When electricity from a 9-volt battery, or hand operated blasting device, passes through the lead wires, a tiny wire connecting the negative lead wire with the positive lead wire heats up, setting-off the heat sensitive priming mixture. When the heat sensitive priming mixture ignites, its ignition energy detonates the lead azide intermediate booster charge. The detonation of the lead azide booster detonates the base charge, which is composed of RDX. In the manufacturing of the blasting cap, the RDX is pressed into the aluminum housing under high pressure, to form a compact mass. The lead azide and priming mixtures are then lightly pressed in (pressing the lead azide and ignition charge into the aluminum housing to hard, could cause premature detonation because lead azide is percussion sensitive).

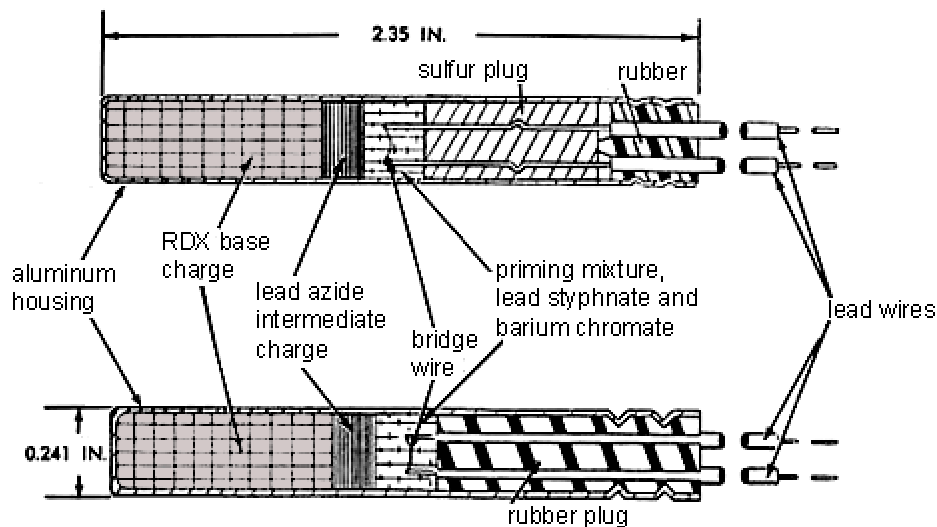

Figure 044. Standard military electric blasting caps. See TM 43-0001-38, June 1981, for additional information on military blasting caps.

Standard non-electric military/commercial blasting caps are commonly used to initiate high explosives and their compositions. The following blasting cap functions in a similar manner as the caps in figure 044, but initiation is accomplished by the use of a black powder time fuse or detonating cord. The time fuse or detonating cord is simply slid into the opening end as far as it can go, and then the end of the cap is crimped to keep the time fuse or detonating cord from sliding out.

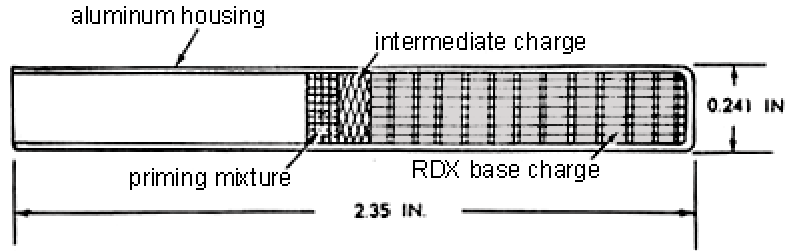

Figure 045. Standard non-electric military blasting cap. See TM 43-0001-38, June 1981, for additional information on military blasting caps.

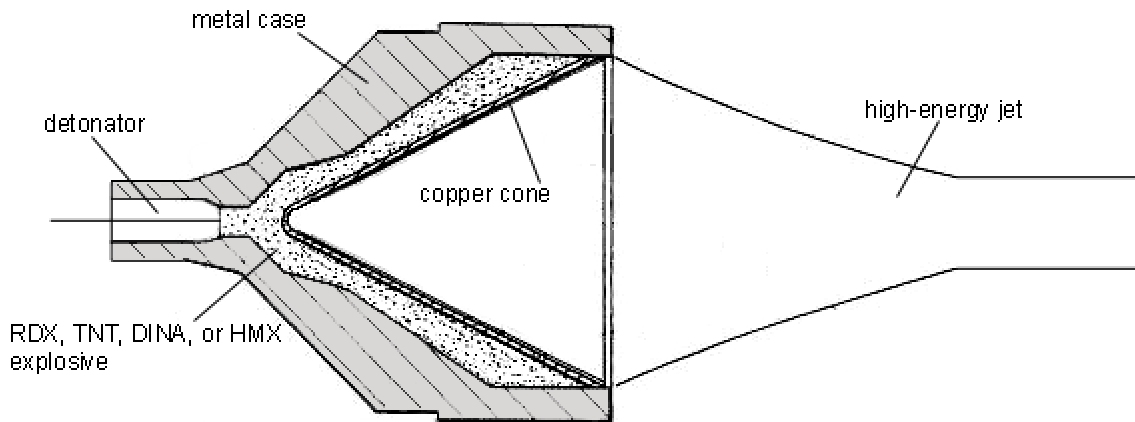

Figure 046. Cut-away close-up view of a hollow (shape) charge warhead

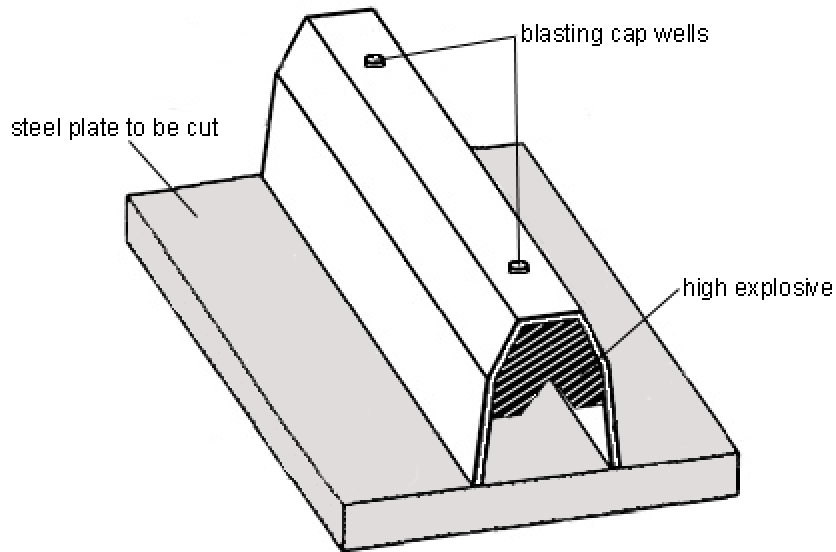

Figure 047. Illustration of a linear hollow (shape) charge.

In the following projectile, which may be a tank fired, or shoulder fired weapon, is composed of a body of shaped high explosive. The projectile is fired at the target, and upon impact, a piezoelectric fuse sends an electric current to the detonator, which detonates the high explosive hollow (shape) charge. A piezoelectric fuse is a simple device, which utilizes specially designed chemical actuated crystals that generate a quick shock of electricity when subjected to severe and sudden pressure. Upon impact, the force of the projectile's forward movement produces severe pressure on the piezoelectric fuse. This pressure causes the special crystals to collapse together, generating the electric current. Piezoelectric fuses are very cheap and easy to make, and are hence, the main electric source in most anti-tank projectiles. Another reason piezoelectric fuses are mainly used is their ability to last for long periods of time in storage. Anti-tank projectiles containing batteries can become inoperable after long periods of storage due to battery failure.

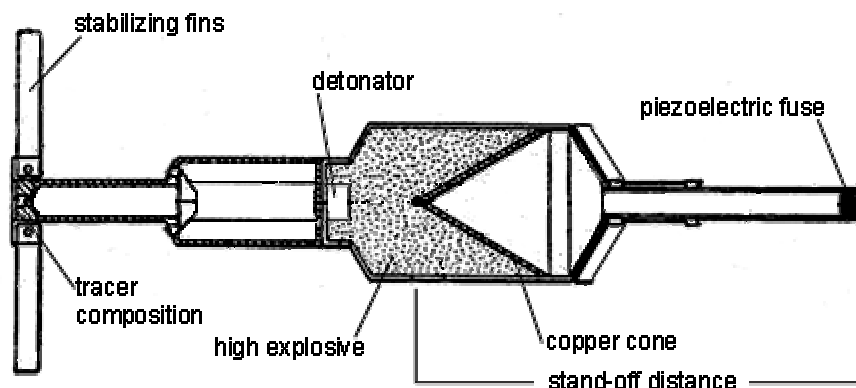
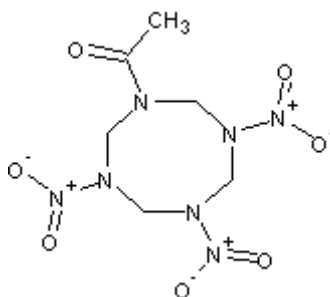

Figure 048. Standard military shape charge, anti-tank projectile.

7-02. Solex. *1-(N)-acetyl-3,5,7-trinitro-cyclotetramethylene tetramine*



Solex

Uses: Substitute for HMX, or RDX in plastic explosives, high performance gun propellants, and rocket propellants. It can be used as a primary component instead of RDX or HMX in explosives compositions, high performance gun propellants, or rocket propellants.

Molecular weight: 278.161	Flammability: Burns with smoky flame (may flash)
Detonating velocity: Similar to RDX	Toxicity: Mild
Sensitivity: Very low (requires primary explosive)	Classification: Secondary explosive
Stability: Very good	Overall value (as secondary explosive): Extremely high

Procedure 7-02A: Preparation of Solex

Materials:	1. 200 grams TAT
	2. 300 grams 99% nitric acid
	3. 96 grams phosphorus pentoxide

Summary: Solex is prepared by nitrating TAT with nitrogen pentoxide. The nitrogen pentoxide is generated by the reaction between nitric acid and phosphorus pentoxide, and is used simultaneously. Commercial & Industrial note: For related, or similar information, see Application No. 476,947, January 3, 1999, by Schlumberger Technology Corporation, to William J. Lukasavage, Pearland, TX, Lawrence A. Behrmann, Houston, TX, and Wallace E. Voreck, Sparta, NJ. Part or parts of this process may be protected by international, and/or commercial/industrial processes. Before using this process to legally manufacture the mentioned explosive, with intent to sell, consult any protected commercial or industrial processes related to, similar to, or additional to, the process discussed in this procedure. This process may be used to legally prepare the mentioned explosive for laboratory, educational, or research purposes.

Hazards: Use great care when handling 99% nitric acid; produces poisonous reddish-brown fumes of nitrogen oxides; use maximum ventilation. Wear gloves when handling phosphorus pentoxide; causes skin irritation.

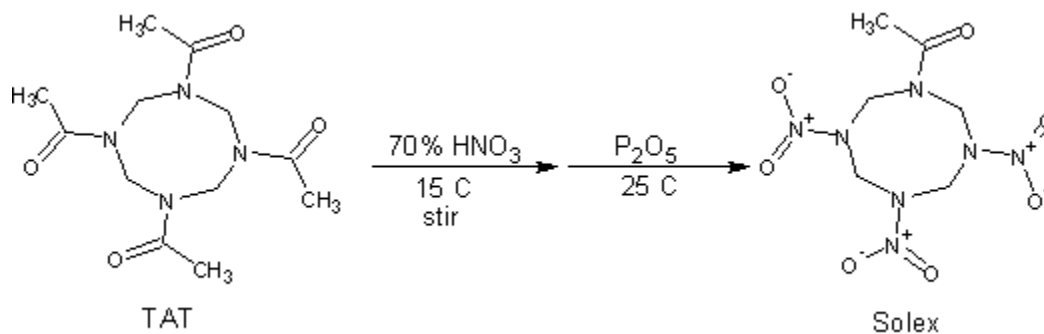
*Reaction Equation*

Procedure: To generate 200 grams of SOLEX, place 300 grams of 99% nitric acid into a beaker and then cool to 10 Celsius by means of a cold water bath. When the temperature of the 99% nitric acid reaches about 10 Celsius, slowly add and dissolve 200 grams of TAT into the 99% nitric acid while stirring the 99% nitric acid and maintaining its temperature at 10 Celsius. After the TAT has dissolved into the 99% nitric acid, add 48 grams of phosphorus pentoxide, and continue stirring the 99% nitric acid solution. Take care to insure that the rate of stirring is sufficient to prevent clumping of the reagents. Clumping can cause localized overheating, a potential hazard. After the addition of the phosphorus pentoxide, continue stirring the reaction mixture for about 2 hours and keep the temperature of the reaction mixture at 10 Celsius. After 2 hours, add 16 additional grams of phosphorus pentoxide and continue stirring the reaction mixture at 10 Celsius for 2 hours. After 2 hours add another 16 grams of phosphorus pentoxide and continue stirring the reaction mixture at 10 Celsius for 2 hours. After 2 hours, add a final 16 grams of phosphorus pentoxide and continue stirring at 10 Celsius for 5 hours. After 5 hours, the reaction mixture will be a gel-like mixture. Then, stop stirring and remove the cold-water bath and allow the reaction mixture to stand for 48 hours at room temperature. After 48 hours add the entire reaction mixture into 1000 milliliters of cold water and stir for 1 hour. After which, filter-off the precipitated solex product, wash with 1000 milliliters of hot water, and then vacuum dry or air-dry.

Notes:

“Solex” solex explosive composition

Procedure: Into a beaker place 160 grams of solex, 10 grams plasticizer of diethylhexylazelate (DEHA), 4 milligrams iron acetylacetonate (FeAA), 150 milligrams of asolectin and 29.84 grams of polybutadiene (R-45M) in toluene diisocyanate. Thereafter, rapidly blend the mixture for 2 hours and then pour the mixture into any desirable mold, container, bomb casing, or warhead casing and cure for 7 days at 60 Celsius in an oven. After 7 days the explosive will be ready for use. Requires a blasting cap or detonator for initiation. Commercial & Industrial note: For related, or similar information, see Application No. 840,367, October 7, 1977, by Her Majesty the Queen in right of Canada, as represented by the Minister, to Guy Perrault, Ste-Foy, Canada, Raynald Francoeur, Nord, Canada, and Roger Lavertu, Ste-Foy, Canada. Part or parts of this laboratory process may be protected by international, and/or commercial/industrial processes. Before using this process to legally manufacture the mentioned explosive, with intent to sell, consult any protected commercial or industrial processes related to, similar to, or additional to, the process discussed in this procedure. This process may be used to legally prepare the mentioned explosive for laboratory, educational, or research purposes.

7-03. HMX. Octogen; 1,3,5,7-tetranitro-1,3,5,7-tetraazacyclooctane; alpha-HMX and beta-HMX

CHAPTER 7: THE PREPARATION OF CYCLIC NITRAMINES

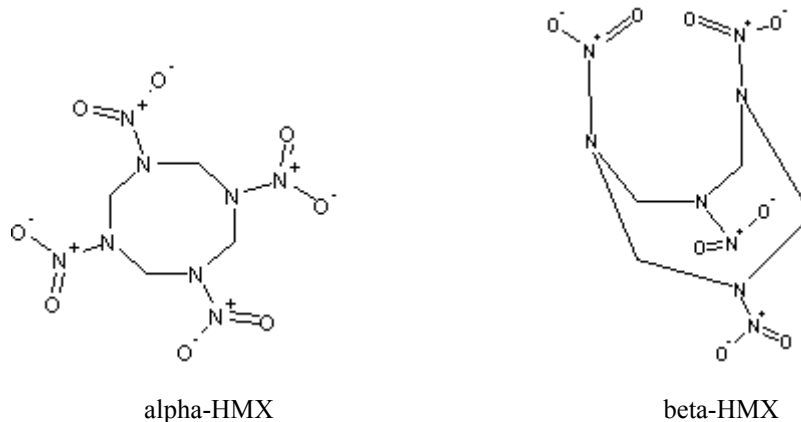

HMX is a very powerful explosive, which is more powerful than RDX. It has exceptional physical properties, and it demonstrates excellent shock and percussion resistance. The use of HMX in explosive compositions and munitions for military purposes is growing, and it is likely it will overtake RDX in the future. HMX exists in two primary modifications: beta-HMX, and alpha HMX. Beta-HMX is useful in hollow charges, but alpha-HMX is more useful in explosives compositions, munitions, high performance rocket propellants, and gun propellants—HMX is a great smoke and flash-reducing agent for propellant formulations.

Molecular weight: 296.156	Flammability: Burns with smoky flame
Detonating velocity: 9100 (calculated)	Toxicity: Mild
Sensitivity: Very low (requires primary explosive)	Classification: Secondary explosive
Stability: Very good	Overall value (as secondary explosive): Extremely high

Procedure 7-03A: Preparation of alpha-HMX

Materials:	1. 200 milliliters 99% nitric acid
	2. 160 grams phosphorus pentoxide
	3. 200 grams solex

Summary: HMX is prepared by reacting solex with nitrogen pentoxide. The nitrogen pentoxide is generated by the reaction between 99% nitric acid and phosphorus pentoxide, and is used simultaneously. Commercial & Industrial note: For related, or similar information, see Application No. 476,947, January 3, 1999, by Schlumberger Technology Corporation, to William J. Lukasavage, Pearland, TX, Lawrence A. Behrmann, Houston, TX, and Wallace E. Voreck, Sparta, NJ. Part or parts of this process may be protected by international, and/or commercial/industrial processes. Before using this process to legally manufacture the mentioned explosive, with intent to sell, consult any protected commercial or industrial processes related to, similar to, or additional to, the process discussed in this procedure. This process may be used to legally prepare the mentioned explosive for laboratory, educational, or research purposes.

Hazards: Use great care when handling 99% nitric acid; produces poisonous reddish-brown fumes of nitrogen oxides; use maximum ventilation. Wear gloves when handling phosphorus pentoxide; causes skin irritation.

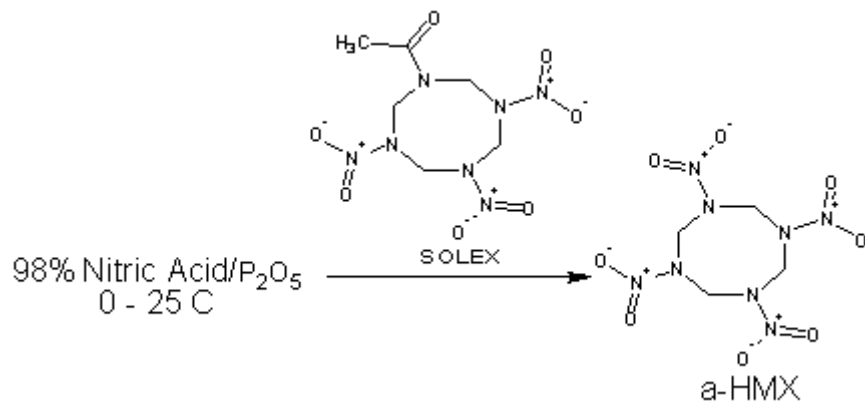

CHAPTER 7: THE PREPARATION OF CYCLIC NITRAMINES
Reaction Equation

Procedure: To prepare 200 grams of HMX, place 200 milliliters of 99% nitric acid into a beaker, and then cool in a cold-water bath. When the 99% nitric acid reaches about 15 Celsius, slowly add 160 grams of phosphorous pentoxide while stirring the 99% nitric acid and maintaining its temperature at 15 Celsius. After the addition of the phosphorus pentoxide, rapidly add 200 grams of SOLEX while rapidly stirring the 99% nitric acid mixture and maintaining its temperature at 15 Celsius (do not exceed 30 Celsius). Care needs to be taken to ensure that the entire mixture is cooled, which is necessary to avoid the possibility of a fume-off (hazardous gas evolution). After the addition of the solex, continue stirring at 15 Celsius for 1 hour, and then place the entire reaction mixture into a shallow pan with a high surface area and allow it to age for 48 hours at room temperature. After aging for 48 hours at room temperature, vacuum filter the reaction mixture to collect the HMX precipitate and then wash the HMX precipitate several times with 400 milliliter portions of hot water, and then vacuum dry or air dry. The dry HMX product will be in high purity.

Conversion of alpha-HMX to beta-HMX

The HMX product obtained in the above procedure, after being washed with water and dried, will be a fluffy powder having a melting point of 277 Celsius. Place 600 milliliters of acetone into a beaker and then heat the acetone to a temperature of about 56 Celsius. When the acetone reaches 56 Celsius, add the HMX product obtained in the above procedure and stir for ten minutes. After ten minutes evaporate the acetone solvent to recover dry crystalline beta-HMX.

Granulation of alpha-HMX

Mix 200 grams of alpha-HMX with 118 grams of a mixed solvent containing 20% gamma butyrolactone, and 80% acetone (commercially available) for 20 minutes to form a paste. Then to the resulting paste add with stirring, 800 milligrams of fine beta-HMX, and stir for several minutes. Afterwards, place the mixture into a shallow pan, and then place the pan into an oven and heat at about 120 Celsius for 40 minutes. After 40 minutes, remove the pan from the oven and allow the HMX mixture to cool to room temperature. Then break the HMX product up into tiny pieces and pass them through a #15 sieve. Then place the resulting powder into a ball mill and rotate at mild speed. Shortly after beginning rotating the ball mill, add 96 milliliters of the commercially available solvent used earlier, and continue rotating the ball mill for five minutes. After which, remove the HMX material from the ball mill and place the HMX material into an oven and heat at 90 Celsius until dry.

Notes:

Procedure 7-03B: Preparation of beta-HMX

Materials:	1. 436 grams 99% nitric acid
	2. 466 grams ammonium nitrate
	3. 34 grams paraformaldehyde
	4. 202 grams hexamine
	5. 400 milliliters acetone
	6. 1900 grams of glacial acetic acid
	7. 1306 grams acetic anhydride

Summary: beta-HMX can be prepared by reacting hexamine with ammonium nitrate and nitric acid in the presence of excess glacial acetic acid and acetic anhydride. The rate of additions is crucial to ensure proper HMX formation. After the reaction is complete, the alpha-HMX is refluxed with water to ensure quality and purification. The resulting water insoluble product is then filtered-off, and then recrystallized from acetone to produce excellent crystals of beta-HMX. Commercial & Industrial note: For related, or similar information, see Serial No. 696,888, November 15th, 1957, by The United States Army, to Jean P. Picard, Morristown, NJ. Part or parts of this laboratory process may be protected by international, and/or commercial/industrial processes. Before using this process to legally manufacture the mentioned explosive, with intent to sell, consult any protected commercial or industrial processes related to, similar to, or additional to, the process discussed in this procedure. This process may be used to legally prepare the mentioned explosive for laboratory, educational, or research purposes.

CHAPTER 7: THE PREPARATION OF CYCLIC NITRAMINES

Hazards: Use great care when handling 99% nitric acid; produces poisonous reddish-brown fumes of nitrogen oxides; use maximum ventilation. Wear gloves when handling acetic anhydride, and glacial acetic acid; both of which can produce skin irritation. Do not allow the reaction mixture temperature to rise above 50 Celsius.

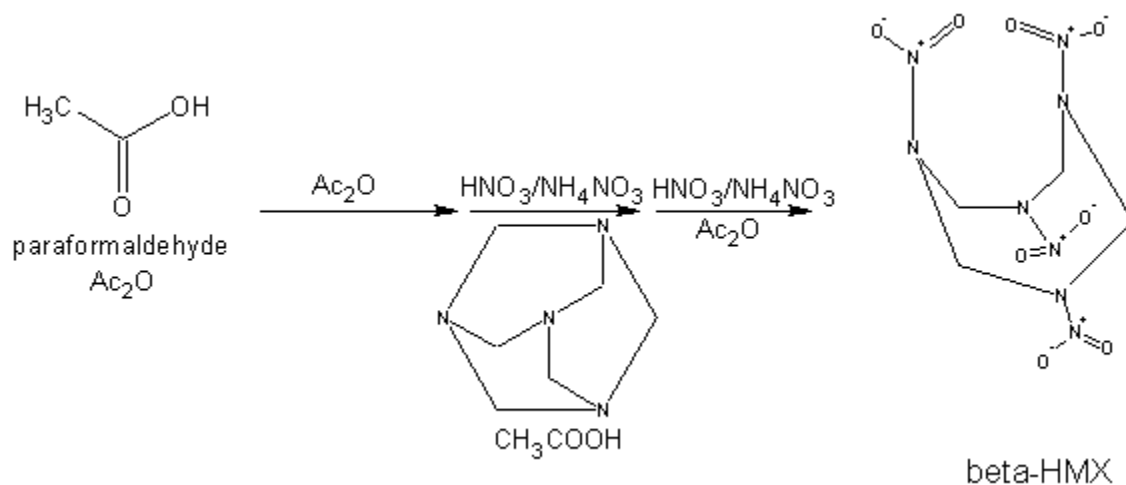

Reaction Equation

Procedure: Note: This procedure uses an excessive amount of 99% nitric acid to properly carry out the reaction. This excessive amount of acid can be recovered by treating the reaction mixture (after complete removal of the product) with methylene chloride to recover the nitric acid. Prior to this action, a small amount of sulfuric acid should be added to the reaction mixture. Afterwards, the reaction mixture should be extracted with several volumes of methylene chloride. These combined volumes can then be carefully distilled to recover the nitric acid of 99% purity (see nitric acid, 90% and 99% respectively).

Add 1570 grams of glacial acetic acid, 26 grams of acetic anhydride, and 34 grams of paraformaldehyde to a large 3-neck flask and then place this flask into a water bath. Now, gather 3 addition funnels, and fill funnel 1 with 640 grams of acetic anhydride, funnel 2 with 360 grams of a bulk ammonium nitrate/nitric acid solution prepared by dissolving 466 grams of ammonium nitrate into 436 grams of 99% nitric acid (keep this solution above 20 Celsius to avoid recrystallization of the ammonium nitrate; keep the remaining acid solution for use later in this procedure), and funnel 3 with a hexamine/acetic acid solution prepared by dissolving 202 grams of hexamine into 330 grams of glacial acetic acid. Then attach these three funnels to the 3-neck flask. Now begin to add the nitric acid/ammonium nitrate solution and hexamine/acetic acid solutions slowly and drop wise to the 3-neck flask while constantly stirring the contents in the flask and maintaining the temperature below 45 Celsius by means of the water bath; both at all times. After about $\frac{1}{4}$ of both solutions have been added, add about 130 milliliters of the acetic anhydride in funnel 1 all at once to the flask. Now, after $\frac{1}{2}$ of both solutions (funnel 2 and 3) has been added, add another 130 milliliters of the acetic anhydride in funnel 1 all at once to the flask. Once more, after the addition of $\frac{3}{4}$ of both solutions (funnel 2 and 3) has been added, add another 130 milliliters of the acetic anhydride in funnel 1 all at once to the flask. After all of both solutions (funnel 2 and 3) have been added, add the rest of the acetic anhydride in funnel 1 all at once to the flask. The additions of both solutions in funnels 2 and 3 should be complete within 30 minutes. After the final addition of the acetic anhydride, allow the contents in the flask to stand for about 30 minutes below 45 Celsius while constantly stirring the contents. After the 30-minute aging period, remove funnel 3, and then to funnels 1 and 2, add 542 grams of the remaining nitric acid/ammonium nitrate solution to funnel 2, and 640 grams of acetic anhydride to funnel 1. Now add these two solutions to the flask drop wise, over a period of 30 minutes while constantly stirring and maintaining the contents in the flask below 45 Celsius. After the addition of both solutions (funnels 1 and 2), add 320 grams of acetic anhydride to the flask all at once with constant stirring. Now allow the contents in the flask to stand for 2 hours below 45 Celsius with constant stirring. After the 2-hour aging period, add 700 milliliters of hot water, and then attach a condenser to the flask, and reflux the contents at 90 to 100 Celsius for 1 hour (with no stirring). After 1 hour, remove the heat source and allow the contents in the flask to cool to room temperature. Afterwards, add the contents in the flask to a large beaker, and then add 4000 grams of crushed ice. Then filter-off the water insoluble product, wash with six 400-milliliter portions each of cold water, and then vacuum dry or air-dry the product. The crude dry product of alpha-HMX will weigh about 400 grams and will contain about 95% alpha-HMX, and 5% RDX. This crude product is then purified and converted to the beta-HMX by adding and dissolving the 400 grams of crude product into 400 milliliters of water free acetone. After which, filter-off any insoluble materials, and then recrystallize the HMX from the acetone, and then vacuum dry or air-dry the product. The result will be high purity beta-HMX.

Notes:

HMX high performance gun propellant

Step 1: Preparation of the polymer

To a large three-necked flask equipped with a mechanical stirrer, condenser, and a heating mantle, add 8600 grams of technical grade butyne-1,4-diol (commercially available), 3000 grams of paraformaldehyde, 100 grams of p-toluene sulfonic acid, and 30 liters of toluene. Then stir the mixture and reflux at 110 Celsius for 8 hours. After 8 hours of refluxing, quickly add 300 grams of paraformaldehyde and 10 grams of p-toluene sulfonic acid and then continue stirring and refluxing at 110 Celsius for 4 hours. After refluxing for 4 hours, remove the heat source, and allow the mixture to cool to room temperature. Afterwards, remove the upper toluene layer by simply decanting it (this toluene can be reused for another batch), and then collect the polymeric precipitate by filtration. After filtration, place the wet polymeric precipitate into a beaker and melt it by gently raising the temperature to 60 Celsius. When the polymer is melted, add 11 liters of hot water, and then remove the heat source. Then stir the whole mixture rapidly for 30 minutes. After 30 minutes, allow the mixture to fully reach room temperature, and then filter-off the polymeric precipitate. Next, place the wet polymeric precipitate into a beaker and re-melt it at 60 Celsius. When the polymeric precipitate has melted, add 11 liters of hot water, and then remove the heat source. Then stir the whole mixture rapidly for 30 minutes. After 30 minutes, allow the mixture to fully reach room temperature, and then filter-off the polymeric precipitate. Then vacuum dry the polymeric precipitate for 2 hours.

Step 2: Preparation of gun propellant

Add 44 grams of the polymer (prepared in step 1) to 150 grams of HMX, and then add 6 grams of hexamethylene diisocyanate. Then heat the mixture to 140 Celsius, and manually blend the mixture for 1 hour. After 1 hour, press the propellant mixture into a desirable mold or container, which have small holes at the end with identical size and shape (the size and shape of the holes can vary), under a pressure of 700 psi. After which, cut the extruded propellant into identical sized pieces, and allow the propellant to cool to room temperature. Do not use a blasting cap or detonator for initiation. Commercial & Industrial note: For related, or similar information, see Application No. 564,972, December 21, 1983, by Thiokol Corporation, to Michael W. Barnes, Brigham, UT, Clifford E. Kristofferson, North Ogden, UT, and Anthony P. Manzara, Stillwater, MN. Part or parts of this laboratory process may be protected by international, and/or commercial/industrial processes. Before using this process to legally manufacture the mentioned explosive, with intent to sell, consult any protected commercial or industrial processes related to, similar to, or additional to, the process discussed in this procedure. This process may be used to legally prepare the mentioned explosive for laboratory, educational, or research purposes.

HMX explosive composite

To a large beaker, add 1950 grams of HMX and 8 liters of water, and then heat the mixture to 75 Celsius while rapidly stirring. Then add 22.4 grams of Kraton G-6500, 27.6 grams of paraffin oil, and then 240 milliliters of butylacetate while stirring the HMX/water mixture and maintaining it temperature at 75 Celsius. After the addition, raise the temperature of the mixture to 80 Celsius, and continue rapidly stirring. Then blow air over the surface of the beaker to aid in the evaporation of the butylacetate solvent (a portable cooling fan will work). Continue heating, stirring, and blowing air over the surface of the beaker until all the butylacetate solvent has been evaporated. After the butylacetate has been evaporated, remove the heat source and stop stirring. Then filter-off the insoluble product, and air-dry. After the product has fully dried, the explosive can then be pressed into a variety of shaped molds, or pressed into bomb casings of various types and/or sizes. Requires blasting cap or detonator for initiation. Commercial & Industrial note: For related, or similar information, see Application No. 920,415, June 29, 1978, by The United States of America, to Theodore M. Benziger, Santa Fe, NM. Part or parts of this laboratory process may be protected by international, and/or commercial/industrial processes. Before using this process to legally manufacture the mentioned explosive, with intent to sell, consult any protected commercial or industrial processes related to, similar to, or additional to, the process discussed in this procedure. This process may be used to legally prepare the mentioned explosive for laboratory, educational, or research purposes.

HMX plastic explosive

Into a beaker place 90 grams of the binder material, Sylgard TM, which is an ethyl silicate resin, and then add 510 grams of HMX and thoroughly mix for 5 hour until a homogeneous mixture results. After mixing for 1 hour, vibrate the beaker for 1 hour to remove air bubbles, and then cast the explosive into any desirable mold or container and then dry for 24 hours in an oven at 50 Celsius. After 24 hours, remove the explosive from the oven, and then remove the explosive from its mold or container. The explosive is then ready to be used. Requires blasting cap or detonator for initiation. Commercial & Industrial

CHAPTER 7: THE PREPARATION OF CYCLIC NITRAMINES

note: Part or parts of this laboratory process may be protected by international, and/or commercial/industrial processes. Before using this process to legally manufacture the mentioned explosive, with intent to sell, consult any protected commercial or industrial processes related to, similar to, or additional to, the process discussed in this procedure. This process may be used to legally prepare the mentioned explosive for laboratory, educational, or research purposes.

“PBX B” HMX plastic bonded explosive

Slurry HMX with water by adding 38.8 grams HMX to 80 milliliters of water, and thoroughly mix for 1 hour. Then prepare a dispersion mixture by adding 1.2 grams of polytetrafluoroethylene resin and 2.7 grams of a non-ionic wetting agent (any will work) into 10 milliliters of water. Then slowly add this dispersion mixture to the HMX slurry, and stir the slurry rapidly for 10 minutes. Afterwards, slowly add 6 grams of acetone while stirring for 4 minutes. After mixing the slurry for 4 minutes, filter-off the HMX explosive, and then place into a shallow pan and allow it to dry for several days. After the explosive product is dried, the result will be a molding powder in the form of a fluffy tacky texture. This explosive can then be rolled into sheets, or pressed under high pressure into any mold, container, bomb casing, or warhead casing. For demolition use, remove the explosive from the container after pressing and wrap in plastic, paper, or cardboard. The explosive when freshly prepared can also be pressed into pellets of various sizes using pressures of 15,000 psi. Requires blasting cap or detonator for initiation. Commercial & Industrial note: For related, or similar information, see Application No. 050,311, August 18, 1960, by Sam B. Wright, Holston Ordnance, Kingsport, TN. Part or parts of this laboratory process may be protected by international, and/or commercial/industrial processes. Before using this process to legally manufacture the mentioned explosive, with intent to sell, consult any protected commercial or industrial processes related to, similar to, or additional to, the process discussed in this procedure. This process may be used to legally prepare the mentioned explosive for laboratory, educational, or research purposes.

HMX explosive composition

Into a beaker, add 400 milliliters of 99% isopropyl alcohol, and then add 10 grams of hydroquinone. Then rapidly stir the mixture for about 1 hour at room temperature. Thereafter, add 90 grams of beta-HMX over a period of 30 minutes while rapidly stirring the mixture. After the addition, continue to rapidly stir the mixture for about 3 hours at room temperature. Afterwards, press the explosive into any desirable mold, bombshell, artillery shell, or any desirable container under high pressure; 10,000 psi to form a dense uniform coherent mass. After which, cure the explosive body for several days in a warm room. Requires blasting cap or detonator for initiation. Commercial & Industrial note: For related, or similar information, see Application No. 836,887, September 23, 1977, by Frederick B. Wagner, III, Elmer, NJ, to Frederick B. Wagner, III, Elmer, NJ, and Anthony J. Izbicki, Reading, PA. Part or parts of this laboratory process may be protected by international, and/or commercial/industrial processes. Before using this process to legally manufacture the mentioned explosive, with intent to sell, consult any protected commercial or industrial processes related to, similar to, or additional to, the process discussed in this procedure. This process may be used to legally prepare the mentioned explosive for laboratory, educational, or research purposes.

7-04. NINHT. 2-nitroimino-5-nitro-hexahydro-1,3,5-triazine

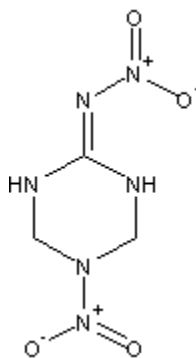

NINHT

NINHT is a high-energy explosive with a high degree of insensitivity, and stability. It may be used with satisfactory results in explosive compositions and rocket propellants, and it can act as a flash suppressant in military gunpowders. NINHT is inexpensive to manufacture, and it shows a remarkable future in high performance gun propellants.

CHAPTER 7: THE PREPARATION OF CYCLIC NITRAMINES

Molecular weight: 190.119	Flammability: Burns with a flash when ignited
Detonating velocity: 7300 (estimated)	Toxicity: Mild
Sensitivity: Very low (requires primary explosive)	Classification: Secondary explosive
Stability: Very good	Overall value (as secondary explosive): High

Procedure 7-04A: Preparation of NINHT

Materials:	1. 1500 milliliters 35 - 38% hydrochloric acid
	2. 82 grams nitroguanidine
	3. 200 grams hexamine
	4. 200 milliliters methanol
	5. 8.58 grams sodium nitrite
	6. 126 milliliters 5% hydrochloric acid solution
	7. 20 milliliters 99% nitric acid

Summary: 2-nitroimino-5-nitro-hexahydro-1,3,5-triazine (NINHT), is prepared in a three step process. 2-nitroimino-hexahydro-1,3,5-triazine hydrochloride is first prepared by reacting hexamine with hydrochloric acid and nitroguanidine. This is converted to 2-nitroimino-5-nitroso-hexahydro-1,3,5-triazine by reaction with sodium nitrite and hydrochloric acid. Finally, 2-nitroimino-5-nitroso-hexahydro-1,3,5-triazine is converted to 2-nitroimino-5-nitro-hexahydro-1,3,5-triazine (NINHT) by reaction with fuming nitric acid at low temperature. Commercial & Industrial note: For related, or similar information, see Application No. 446,357, December 5, 1989, by Aerojet General Corporation, to Der-Shing Huang, Carmichael, CA, and Renato R. Rindone, Fair Oaks, CA. Part or parts of this laboratory process may be protected by international, and/or commercial/industrial processes. Before using this process to legally manufacture the mentioned explosive, with intent to sell, consult any protected commercial or industrial processes related to, similar to, or additional to, the process discussed in this procedure. This process may be used to legally prepare the mentioned explosive for laboratory, educational, or research purposes.

Hazards: Warning! Wear gloves and use proper ventilation when handling 99% nitric acid. 99% Nitric acid is a highly toxic and corrosive liquid evolving poisonous fumes of nitrogen oxides. Handle with great care. Wear gloves and use proper ventilation when handling 35 – 38% hydrochloric acid. 35 – 38% Hydrochloric acid is a highly fuming liquid evolving choking and corrosive fumes. Handle with care.

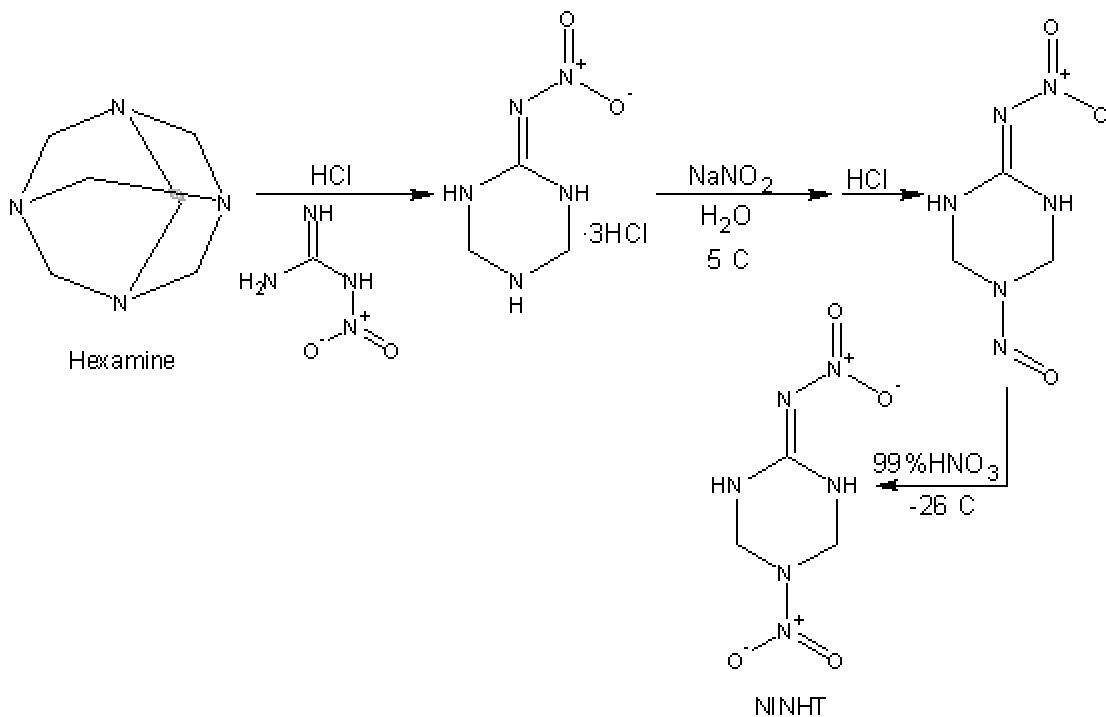

Reaction Equation

Procedure:

Step 1: Preparation of 2-nitroimino-hexahydro-1,3,5-triazine hydrochloride

Place 1500 milliliters of 35 – 38% hydrochloric acid into a 3-neck flask fitted with a condenser, a magnetic stirrer, and thermometer. Then add 82 grams nitroguanidine in one portion with stirring. (The nitroguanidine will require about 1 hour to dissolve). After adding and dissolving the nitroguanidine, add 200 grams of hexamamine in several portions over a 40-minute period. The reaction temperature will rise from room temperature to 38 Celsius. Upon completion of the hexamine addition, stir the reaction mixture over-night. During which time the product precipitates as a white powder. Then, filter-off the product, wash with 200 milliliters of methanol, and then vacuum dry or air-dry the product. The resulting product will weigh 103 grams, and will have a melting point of 189 Celsius (with decomposition).

Step 2: Preparation of 2-nitroimino-5-nitroso-hexahydro-1,3,5-triazine

Place 8.58 grams of sodium nitrite and 330 milliliters of water into a 3-neck flask fitted with a stirrer bar, thermometer, a condenser, and addition funnel. Then cool the flask to 0 Celsius by means of an ice bath, and then add 6 grams of the product obtained in step 1, in one portion. Afterwards, add 126 milliliters of a 5% hydrochloric acid solution drop wise, over a 30 minute period while maintaining the temperature of the flask at 0 Celsius. After the addition of the 5% hydrochloric acid, stir the resulting white slurry at room temperature for 3 hours. After 3 hours, filter-off the product, wash with 150 milliliters of water, and then vacuum dry or air dry. The final product will weigh 5.46 grams and will have a melting point of 193 degrees Celsius (with decomposition).

Step 3: Preparation of 2-nitroimino-5-nitro-hexahydro-1,3,5-triazine (NINHT)

Place 20 milliliters of 99% nitric acid into a 3-neck flask fitted with a magnetic stirrer, thermometer, and condenser. Then cool the flask to –26 Celsius by the means of a dry ice/acetone bath. Then add 1.52 grams of the product obtained in step 2, in several portions, while stirring the mixture over an 20-minute period. Following the addition, maintain the temperature of the flask at –26 Celsius for 1 hour. After 1 hour, remove the flask from the dry ice/acetone bath, and place into an ice bath to maintain the temperature at 0 Celsius. Maintain the temperature of the flask at 0 Celsius for one hour. Afterwards, treat the reaction mixture with 200 grams of ice. A blue-colored mixture results following the ice treatment, which then turns to a white slurry mixture. Afterwards, filter-off the product, wash with 200 milliliters of cold water, and then vacuum dry or air-dry the product. The product will weigh 1.5 grams, and will have a melting point of 207 Celsius (with decomposition).

Notes:

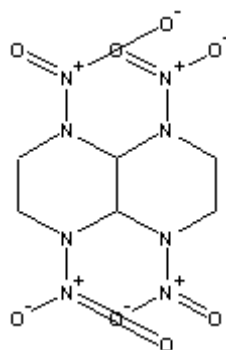
7-05. TNAD. 1,4,5,8-Tetranitro-1,4,5,8-tetraazadecalin

TNAD

TNAD is a powerful explosive with excellent properties and stability. Its use in military explosives is moderate, but will show remarkable use in the future—as it grows in popularity. It has essentially the same density as RDX, and only a slightly lower calculated detonation velocity. TNAD has a melting point of 232-234 Celsius, and is used in propellant compositions, and

CHAPTER 7: THE PREPARATION OF CYCLIC NITRAMINES

explosive compositions. TNAD demonstrates practical use for missile warheads, and artillery shells as it has high impact resistance, and heat stability.

Molecular weight: 322.194	Flammability: Burns with smoky flame
Detonating velocity: 8210 (calculated)	Toxicity: Mild
Sensitivity: Very low (requires primary explosive)	Classification: Secondary explosive
Stability: Very good	Overall value (as secondary explosive): High

Procedure 7-05A: Preparation of TNAD

Materials:	1. 48 grams of ethylenediamine
	2. 29 grams of 40% glyoxal solution
	3. 6.9 grams sodium nitrite
	4. 8 milliliters of 35 – 38% hydrochloric acid
	5. 40 milliliters 99% nitric acid
	6. 200 grams of 95% ethanol

Summary: TNAD is prepared in a four-step process starting with the preparation of 1,4,5,8-Tetraazadecalin. 1,4,5,8-Tetraazadecalin is prepared by reacting ethylenediamine with glyoxal. The 1,4,5,8-Tetraazadecalin is then recovered, and converted into 1,4,5,8-Tetranitroso-1,4,5,8-tetraazadecalin by reaction with sodium nitrite and hydrochloric acid. The 1,4,5,8-Tetranitroso-1,4,5,8-tetraazadecalin is then converted into the nitroso/nitro intermediate by reaction with fuming nitric acid at 30 Celsius. The corresponding 8-Nitroso-1,4,5-trinitro-1,4,5,8-tetraazadecalin is then converted to 1,4,5,8-Tetranitro-1,4,5,8-tetraazadecalin (TNAD) by reaction with fuming nitric acid at 0 Celsius. The product is then collected by filtration, washed, and then dried. Commercial & Industrial note: For related, or similar information, see Application No. 349,134, February 16, 1982, by The United States Navy, to Rodney L. Willer, Ridgecrest, CA. Part or parts of this laboratory process may be protected by international, and/or commercial/industrial processes. Before using this process to legally manufacture the mentioned explosive, with intent to sell, consult any protected commercial or industrial processes related to, similar to, or additional to, the process discussed in this procedure. This process may be used to legally prepare the mentioned explosive for laboratory, educational, or research purposes.

Hazards: Warning! Wear gloves and use proper ventilation when handling 99% nitric acid. 99% nitric acid is a highly poisonous and corrosive liquid, which evolves poisonous fumes. Handle with great care. Use proper ventilation when handling 35 – 38% hydrochloric acid, which is a highly fuming and corrosive liquid. Use care and avoid breathing the choking and toxic fumes.

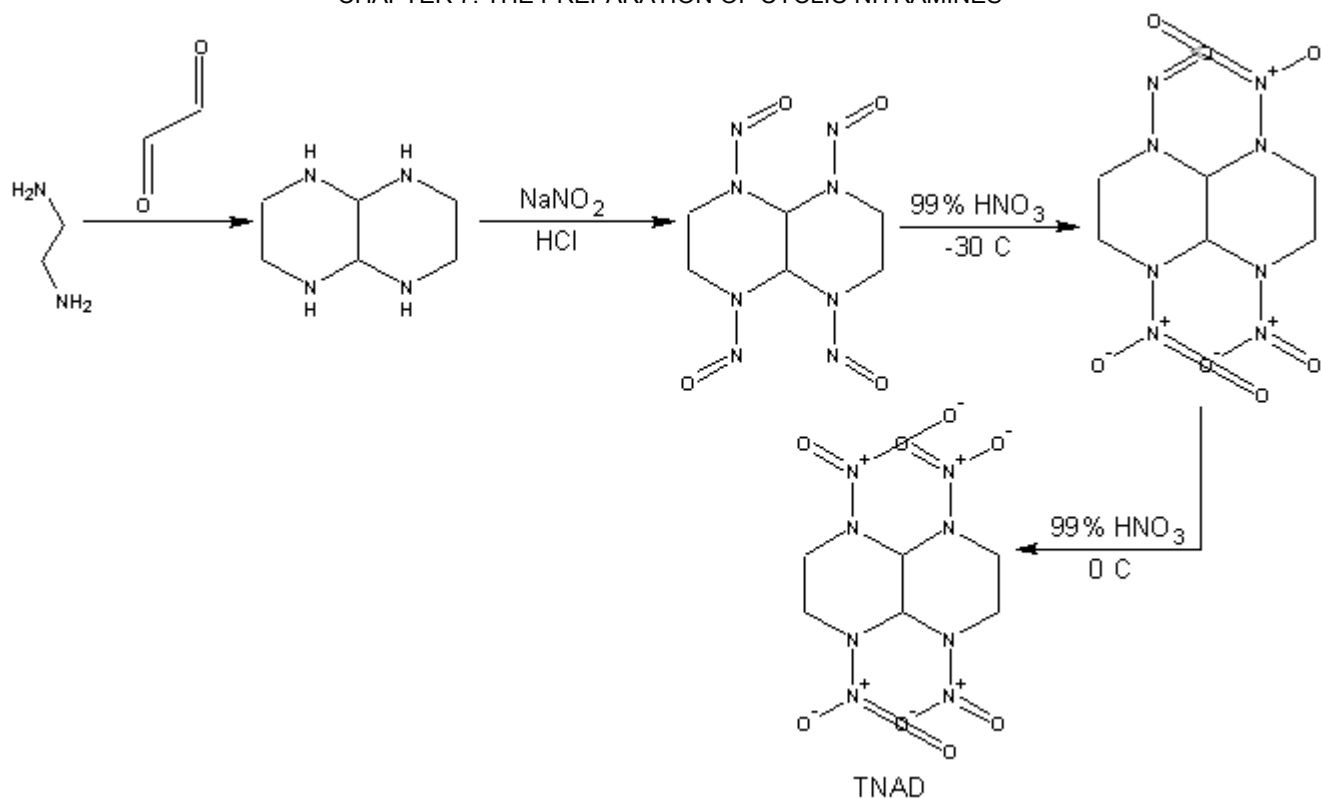

Reaction Equation

Procedure:

Step 1: Preparation of 1,4,5,8-Tetraazadecalin

Place 48 grams of ethylenediamine into a suitable flask, and then cool this flask to 0 Celsius by means of an ice bath. Afterwards, slowly add, drop wise, 29 grams of a 40% glyoxal solution over a period of 1 hour while stirring the ethylenediamine, and maintain its temperature at 0 Celsius. After addition of the 40% glyoxal, heat the reaction mixture while stirring at 80 Celsius for 6 hours. During the heating period, crystals will form in the solution. After 6 hours, remove the heat source, and allow the reaction mixture to cool to room temperature. Then place the reaction mixture into an ice bath, and cool to 0 Celsius. After which, filter-off the product, and then wash with a cold ethanol solution (prepared by diluting 200 grams of 95% ethanol with 180 milliliters of water, and then cooling the mixture to 0 Celsius by placing it in an ice bath). After washing with the cold ethanol solution, vacuum dry or air-dry the product. The dry product will weigh 24 grams, and will have a melting point of 162 Celsius (with decomposition).

Step 2: Preparation of 1,4,5,8-Tetranitroso-1,4,5,8-tetraazadecalin

Prepare a solution by adding 6.9 grams of sodium nitrite and 2.84 grams of 1,4,5,8-tetraazadecalin (prepared in step 1) into 100 milliliters of ice cold water, and then cool the solution to 0 Celsius by means of an ice bath. While maintaining the solution at 0 Celsius and stirring, add 100 milliliters of dilute hydrochloric acid over a period of 2 minutes (prepare the dilute hydrochloric acid by dissolving 8 milliliters of 35 – 38% hydrochloric acid into 90 milliliters of cold water). A white precipitate forms immediately. After addition of the dilute hydrochloric acid, continue stirring at 0 Celsius for 1 hour. After 1 hour, remove the ice bath, and then allow the reaction mixture to warm to room temperature. Thereafter, stir at room temperature for 1 hour. Afterwards, filter-off the product, wash with 500 milliliters of cold water, and then dry overnight in an oven at 80 Celsius. The result will be an off-white powder weighing 4.7 grams with a melting point of 211 Celsius (with decomposition).

Step 3: Preparation of 8-Nitroso-1,4,5-trinitro-1,4,5,8-tetraazadecalin

Place 20 milliliters of 99% nitric acid and a magnetic stirring bar into a suitable flask, and then cool this flask to -30°C by means of a dry ice/acetone bath. Then add 2 grams of 1,4,5,8-tetranitroso-1,4,5,8-tetraazadecalin (prepared in step 2) over period of 1 hour while stirring the 99% nitric acid, and maintain its temperature at -30°C at all times. After the addition,

CHAPTER 7: THE PREPARATION OF CYCLIC NITRAMINES

remove the dry ice/acetone bath, and replace it with an ice bath. Then stir the reaction mixture at 0 Celsius for 1 hour. After which, pour the entire reaction mixture onto 100 grams of ice. A fine white precipitate will form. After the ice melts, filter-off the crude product, wash with 500 milliliters of cold water, and then vacuum dry or air-dry. The yield will be 2.14 grams of crude product with a melting point of 210 Celsius (with decomposition). The crude product will contain small amounts of the tetranitro compound. This crude product need not be purified for use in the next step.

Step 4: Preparation of 1,4,5,8-Tetranitro-1,4,5,8-tetraazadecalin

Place 20 milliliters of 99% nitric acid into a flask, and then cool to 0 Celsius by means of an ice bath. When the temperature reaches 0 Celsius, slowly add 2 grams of 8-nitroso-1,4,5-trinitro-1,4,5,8-tetraazadecalin (prepared in step 3) over a 30 minute period while stirring the 99% nitric acid, and maintain its temperature at 0 Celsius. The solution will develop a light-yellow color. After the addition, stir the reaction mixture at 0 Celsius for 10 minutes. Afterwards, pour the entire reaction mixture onto 40 grams of ice. After the ice has melted, filter-off the product, wash with 500 milliliters of cold water, and then vacuum dry or air-dry. The product will weigh 1.4 grams with a melting point of 236 Celsius (with decomposition). If desired, the product can be recrystallized from a cyclohexanone/95% ethanol solvent mixture (to prepare the solvent: the amount of cyclohexanone used should be 10 milliliters per 1 gram of product, followed by adding the determined amount of cyclohexanone to an equal volume of 95% ethanol). Afterwards, wash the product with 500 milliliters of water, and then vacuum dry or air-dry the product.

Notes:

7-06. DPT. 1,5-methylene-3,7-dinitro-1,3,5,7-tetraazacyclooctane

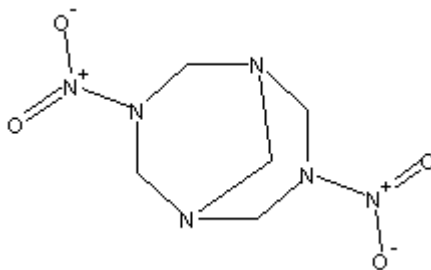

DPT

Uses: Substitute for TNAD, HMX, RDX, and solex in high performance gun propellants and rocket propellants—it can be used in combination with the aforementioned explosives to increase performance and reduce flash emissions.

Molecular weight: 218.173	Flammability: Burns with smoky flame
Detonating velocity: Not calculated	Toxicity: Mild
Sensitivity: Very low (requires primary explosive)	Classification: Secondary explosive
Stability: Very good	Overall value (as secondary explosive): Moderate

Procedure 7-06A: Preparation of DPT

Materials:	1. 21 grams nitrourea
	2. 120 milliliters 37% formaldehyde solution
	3. 200 milliliters of 5% sodium hydroxide solution (<i>prepare by dissolving 5 grams of sodium hydroxide into 95 milliliters of water</i>)
	4. 300 milliliters of 28 – 30% ammonia solution (stock solution)

Summary: 1,5-methylene-3,7-dinitro-1,3,5,7-tetraazacyclooctane, DPT, is easily prepared by reacting formaldehyde with nitrourea. The resulting reaction mixture is then treated with sodium hydroxide, and then with ammonia solution to precipitate the DPT. The DPT is then collected by filtration, washed with water, and then vacuum dried or air-dried. Commercial & Industrial note: For related, or similar information, see Application No. 254,567, April 15, 1981, by The United States Army,

CHAPTER 7: THE PREPARATION OF CYCLIC NITRAMINES

to Richard A. Strecker, Randolph, NJ. Part or parts of this laboratory process may be protected by international, and/or commercial/industrial processes. Before using this process to legally manufacture the mentioned explosive, with intent to sell, consult any protected commercial or industrial processes related to, similar to, or additional to, the process discussed in this procedure. This process may be used to legally prepare the mentioned explosive for laboratory, educational, or research purposes.

Hazards: Use proper ventilation when handling 37% formaldehyde, and 28 – 30% ammonia solution.

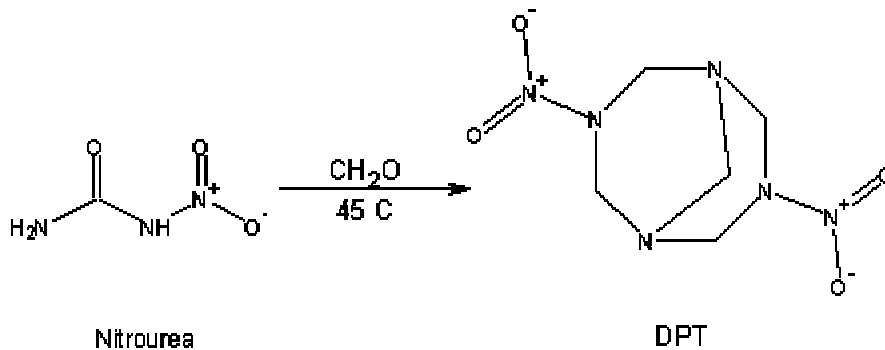

Reaction Equation

Procedure: Add 21 grams of nitrourea into 120 milliliters of 37% aqueous formaldehyde while stirring the 37% formaldehyde. After addition of the nitrourea, heat the mixture to 45 Celsius while stirring until the nitrourea has been completely dissolved. As soon as the nitrourea dissolves, remove the heat source, and then allow the mixture to cool to room temperature. Afterwards, rapidly add 200 milliliters of a 5% sodium hydroxide solution while stirring the reaction mixture. After addition, stir the reaction mixture for 1 hour. Then heat the reaction mixture to 65 Celsius for 1 hour while stirring. After heating for 1 hour, remove the heat source, and allow the reaction mixture to cool to room temperature. Afterwards, slowly add 200 milliliters of 28 - 30% ammonia solution. Upon the addition of the 28 - 30% ammonia solution, the product immediately begins to precipitate. After the addition of the 28 - 30% ammonia solution, filter-off the precipitated product, and then add 100 milliliters of additional 28 - 30% ammonia solution to the filtered mixture. After which, re-filter the mixture (using the same filter as before) to recover more precipitated product (in some cases no more precipitate will form). Then wash the filtered-off precipitate with 500 milliliters of cold water, and then vacuum dry or air-dry the product. The product will weigh 11.6 grams.

CHAPTER 8: THE PREPARATION OF NITRAMINES

DITN, DMMD, TETRYL, MNA, METHYLENE DINITRAMINE, HNIW

8-01. DITN. *Diisopropylamine trinitrate*

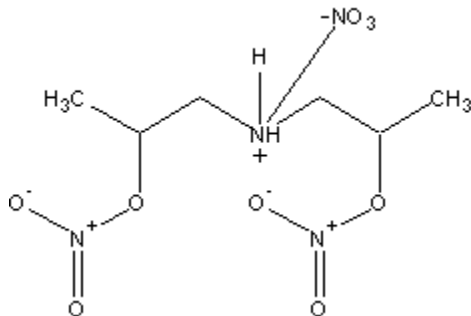

DITN

DITN forms a white crystalline solid with a melting point of 120 Celsius. It is very stable, being insensitive to shock, friction, and percussion, but it is more readily detonated than RDX—as such it can be used in blasting caps as a replacement for RDX. It is readily soluble in hot water without decomposition.

Molecular weight: 286.197	Flammability: Flashes when ignited
Detonating velocity: Not calculated	Toxicity: Mild
Sensitivity: Low	Classification: Secondary explosive
Stability: Very good	Overall value (as secondary explosive): Moderate

Procedure 8-01A: Preparation of DITN

Materials:	1. 200 grams diisopropylamine
	2. 134 grams 70% nitric acid
	3. 1208 grams 99% nitric acid

Summary: DITN can be prepared by reacting the nitrate salt of diisopropylamine with 99% nitric acid. This nitrate salt is simply prepared by neutralizing the amine with 70% nitric acid, followed by evaporation of the water under vacuum. The nitrate is then directly nitrated with 99% nitric acid, and the product is then collected by low temperature precipitation, followed by filtration. Purification is accomplished by precipitation from a water solution at low temperature. Commercial & Industrial note: Part or parts of this laboratory process may be protected by international, and/or commercial/industrial processes. Before using this process to legally manufacture the mentioned explosive, with intent to sell, consult any protected commercial or industrial processes related to, similar to, or additional to, the process discussed in this procedure. This process may be used to legally prepare the mentioned explosive for laboratory, educational, or research purposes.

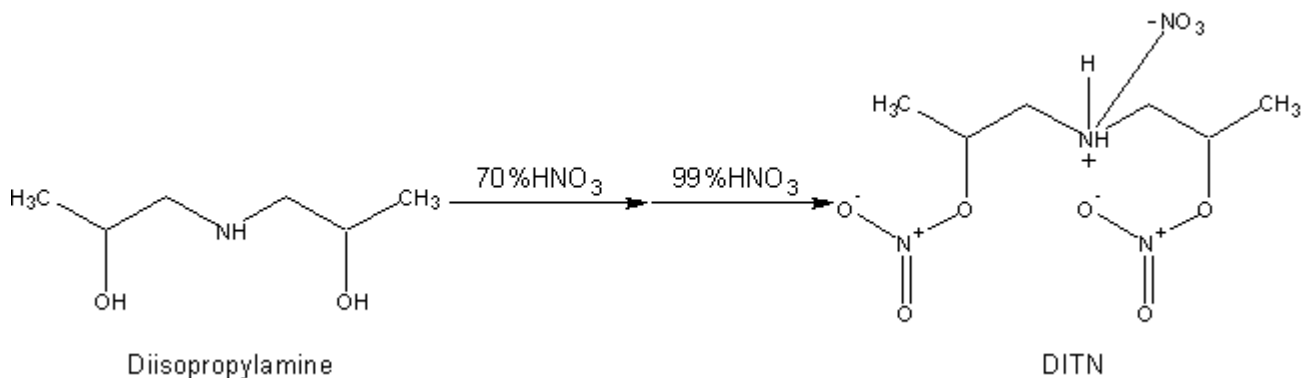

CHAPTER 8: THE PREPARATION OF NITRAMINES
Reaction Equation

Hazards: Wear gloves and use proper ventilation when handling 99% nitric acid. Avoid inhalation of the poisonous vapors.

Procedure: Note: This procedure uses an excessive amount of 99% nitric acid to properly carry out the reaction. This excessive amount of acid can be recovered by treating the reaction mixture (after complete removal of the product) with methylene chloride to recover the nitric acid. Prior to this action, a small amount of sulfuric acid should be added to the reaction mixture. Afterwards, the reaction mixture should be extracted with several volumes of methylene chloride. These combined volumes can then be carefully distilled to recover the nitric acid of 99% purity (see nitric acid, 90% and 99% respectively).

Into a proper flask, add 54 milliliters of warm water, and then add and dissolve 200 grams of diisopropylamine with stirring. Then place 134 grams of 70% nitric into a beaker, and then chill this beaker to 0 Celsius by means of an ice/salt bath. Thereafter, add drop-wise, the diisopropylamine solution to the nitric acid over a period of about 3 hours. During the addition, rapidly stir the nitric acid, and keep its temperature below 10 Celsius. After the addition, place the mixture into a rotary evaporator or vacuum distillation apparatus and remove the water under vacuum. When most of the water has been removed, and when a thick yellow oil remains, remove the oily liquid and place in a dropping funnel. Then add 1208 grams of 99% nitric acid into a beaker, and then cool this beaker to 0 Celsius by means of an ice/salt bath. Thereafter, add drop-wise, the oily liquid in the dropping funnel to the 99% nitric acid over a period of 3 hours. During the addition, rapidly stir the 99% nitric acid and keep its temperature below 10 Celsius. After the addition, drain the entire reaction mixture into 2700 milliliters of ice water. Afterwards, place the ice water mixture into a freezer at 5 Celsius for about 50 minutes. Thereafter, filter-off the precipitated solid product, wash with 500 milliliters of ice-cold water, cooled to about 5 Celsius, and then vacuum dry or air-dry the product. Then place 6 liters of water into a large beaker, and bring to a boil. Thereafter, add and dissolve the dry solid product. Immediately thereafter, remove the heat source, and cool to room temperature. Then place the mixture into a freezer at 5 Celsius for 30 minutes. After which, filter-off the precipitated solid product, wash with three 250 milliliter portions of ice cold water, and then vacuum dry or air-dry the product. The result will be 154 grams of the pure product in the form of white, free flowing crystals. Note: the water, and water washings will contain some dissolved product. These elements can be reused in a second batch of DITN.

Notes:

8-02. DMMD. *2,4-dinitro-2,4-diazapentane*

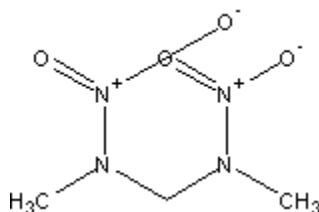

DMMD

DMMD forms white crystals with a melting point of 56 Celsius. Its potential uses include: high-energy plasticizer for plastic explosives and nitroglycerin free dynamites, flexible sheet explosives with RDX, HMX, or DPT, and rocket propellant formulations.

Molecular weight: 164.121	Flammability: Flashes when ignited
Detonating velocity: Not calculated	Toxicity: Mild
Sensitivity: Low	Classification: Secondary explosive
Stability: Very good	Overall value (as secondary explosive): Moderate

Procedure 8-02A: Preparation of DMMD

Materials:	1. 202 milliliters of 37% formaldehyde solution
	2. 233.6 grams methylnitramine

CHAPTER 8: THE PREPARATION OF NITRAMINES

	3. 1200 milliliters of methylene chloride
	4. 300 grams anhydrous magnesium sulfate
	5. 600 milliliters of 98% sulfuric acid
	6. 200 grams chloroform
	7. 200 grams hexanes

Summary: DMMB is prepared by converting methylnitramine into 2-nitro-2-aza-1-propanol by reaction with concentrated formaldehyde solution. The resulting reaction mixture is then extracted with methylene chloride, and the methylene chloride extracts mixed with additional methylnitramine, treated with concentrated sulfuric acid, evaporated, and then the oily contaminated product treated with a solvent mixture composed of chloroform and hexanes. The solvent mixture causes the desired product to precipitate. The DMMD is then collected by filtration, and dried. Commercial & Industrial note: For related, or similar information, see Application No. 391,902, June 25, 1982, by The United States Navy, to Robert C. Gill. White Plains, MD, George W. Naufflett, Fort Washington, MD. Part or parts of this laboratory process may be protected by international, and/or commercial/industrial processes. Before using this process to legally manufacture the mentioned explosive, with intent to sell, consult any protected commercial or industrial processes related to, similar to, or additional to, the process discussed in this procedure. This process may be used to legally prepare the mentioned explosive for laboratory, educational, or research purposes.

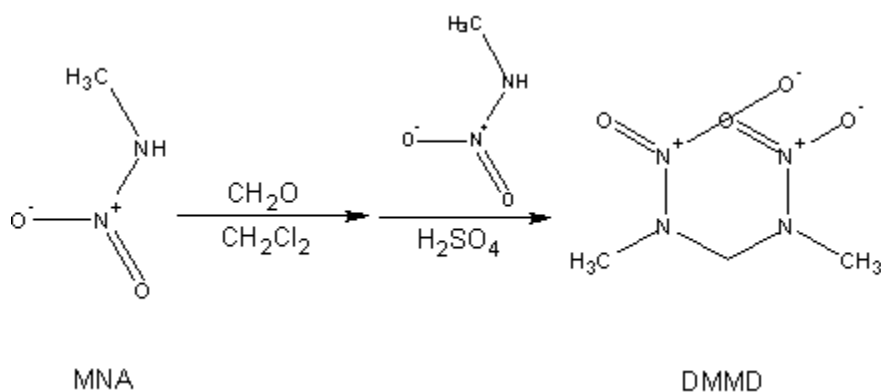

Reaction Equation

Hazards: Use proper ventilation when handling concentrated formaldehyde. Formaldehyde inhalation causes dizziness, and in some cases, a sense of “drunkness”, or “high”; use maximum ventilation. Use caution when handling concentrated sulfuric acid; wear gloves.

Procedure:

Step 1: Preparation of 2-nitro-2-aza-1-propanol

Place 202 milliliters of 37% formaldehyde into a suitable flask, and then place the flask into a water bath to keep the temperature around 20 Celsius. Then add 121.6 grams of methylnitramine in portions over a moderately short time. After the addition, stir the mixture at 20 Celsius for 1 hour. After 1 hour, extract the mixture with six, 100-milliliter portions of methylene chloride. After the extraction, combine all methylene chloride extracts (if not already done so), and then add 100 grams of anhydrous magnesium sulfate (to absorb moisture). Afterwards, filter off the magnesium sulfate and leave the methylene chloride mixture for step 2.

Step 2: Preparation of DMMD

To the 2-nitro-2-aza-propanol/methylene chloride mixture, prepared in step 1, add 112 grams of methylnitramine. Then add 600 milliliters of 98% sulfuric acid into a suitable flask, and then chill to -10 Celsius by means of an ice bath. Then gradually add the 2-nitro-2-aza-1-propanol/methylene chloride solution in portions to the 98% sulfuric acid while stirring the sulfuric acid and maintaining its temperature below 0 Celsius. After the addition, add the entire reaction mixture into 2000 milliliters of cold water. Then decant the upper methylene chloride layer (keep for later), and then extract the bottom water layer with six, 100-milliliter portions of methylene chloride. Afterwards, combine all the methylene chloride layers (if not already done so), and include the upper methylene chloride layer decanted earlier. Then wash the methylene chloride fraction with two 300 milliliters portions of cold water (in this washing, the methylene chloride layer will be the bottom layer both times). After the

CHAPTER 8: THE PREPARATION OF NITRAMINES

water washing, add 200 grams of anhydrous magnesium sulfate to the methylene chloride (to absorb moisture). Then filter-off the magnesium sulfate, and then evaporate-off the methylene chloride (a rotary evaporator works best, but careful distillation can be used instead). The result will be an oily liquid, after the solvent has been removed. Now prepare a solvent mixture by adding 200 grams of chloroform to 200 grams of hexanes, and then add the oily liquid to the solvent mixture with stirring. The desired product, DMMD, will precipitate as white crystals. The white crystals are then collected by filtration, and vacuum dried or air-dried.

Notes:

8-03. Tetryl. Nitramine; *N*-methyl-*N*,2,4,6-tetranitrobenzenamine

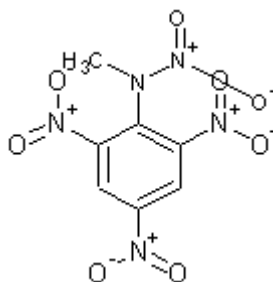

Tetryl

Tetryl forms yellow crystals with a melting point of 132 Celsius—it explodes when heated to 180 Celsius. It is insoluble in water, but soluble in alcohol, benzene, and acetic acid. Solutions of tetryl in solvents should be stored in a dark place, protected from light—as they will slowly deteriorate on standing—normally tetryl is stored dry or moistened with kerosene or water. Solutions of tetryl or even the dry solid upon the skin and teeth causes yellow staining. Tetryl is a very powerful explosive used primarily in detonators as a booster for artillery, mortar, and projectile fuses. Tetryl is a standard military initiating explosive (booster). Tetryl boosters are common in shape charges, mines, mortars, artillery shells, rockets, anti-tank munitions, and missiles.

Molecular weight: 287.15	Flammability: May detonate when ignited
Detonating velocity: 7850	Toxicity: Moderate
Sensitivity: Low	Classification: Secondary explosive
Stability: Very good	Overall value (as secondary explosive): Extremely high

Procedure 8-03A: Preparation of Tetryl

Materials:	1. 208 grams 99% nitric acid
	2. 350 grams 98% sulfuric acid
	3. 100 grams N,N-dimethylaniline

Summary: The powerful initiating explosive, tetryl, can be made by dissolving N,N-dimethylaniline into excess sulfuric acid, and then reacting this mixture with a strong nitric acid mixture. The reaction temperature must be carefully controlled, and after addition of all the nitrating acid, the reaction mixture is quenched with excess cold water. The water insoluble tetryl product is then easily recovered by filtration. Commercial & Industrial note: Part or parts of this laboratory process may be protected by international, and/or commercial/industrial processes. Before using this process to legally manufacture the mentioned explosive, with intent to sell, consult any protected commercial or industrial processes related to, similar to, or additional to, the process discussed in this procedure. This process may be used to legally prepare the mentioned explosive for laboratory, educational, or research purposes.

Hazards: Warning! Wear gloved and use proper ventilation when handling 99% nitric acid, and 98% sulfuric acid. 99% Nitric acid is highly toxic, and emits poisonous fumes of nitrogen oxides. Handle with extreme care.

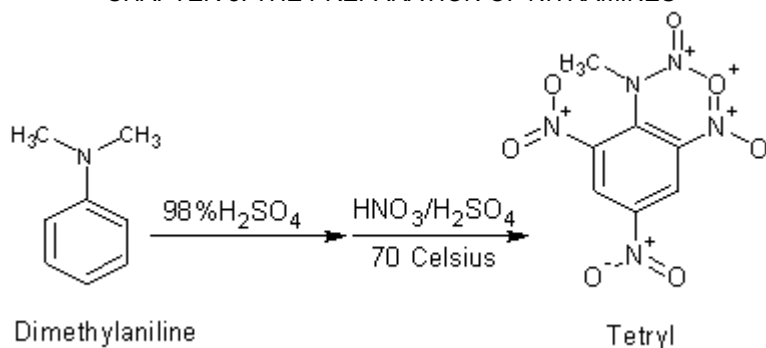
*Reaction Equation*

Procedure: Place 300 grams of 98% sulfuric into a flask, and then cool in a cold-water bath. Then add 100 grams of N,N-dimethylaniline while stirring the 98% sulfuric acid, and maintain its temperature below 20 Celsius by means of the cold water bath. Afterwards, prepare a 99% nitric acid water solution by mixing 208 grams of 99% nitric acid into 52 grams of water, and then place this mixture into an ice bath and cool to 0 Celsius while stirring. Then place 50 grams of 98% sulfuric acid into a beaker and then cool to 0 Celsius by means of an ice bath. When both acids reach a temperature of 0 Celsius, add the 98% sulfuric acid to the nitric acid solution, and then stir the acid mixture and keep its temperature at 0 Celsius. After which, remove the N,N-dimethylaniline/98% sulfuric acid mixture from the cold water bath, and then heat to 70 Celsius. Then, while maintaining this temperature, slowly add the nitric acid solution/98% sulfuric acid mixture over a period of 2 hours while constantly stirring the N,N-dimethylaniline/98% sulfuric acid mixture. After addition of the acid mixture, continue stirring and heating at 70 Celsius for 1 hour. After 1 hour, remove the heat source and allow the reaction mixture to cool to room temperature. After which, add the entire reaction mixture to 1000 milliliters of cold water. Then filter-off the precipitated tetryl, wash with 500 milliliters of cold water several times, and then vacuum dry or air-dry the product. If desired, the tetryl can be recrystallized from 1000 milliliters of benzene.

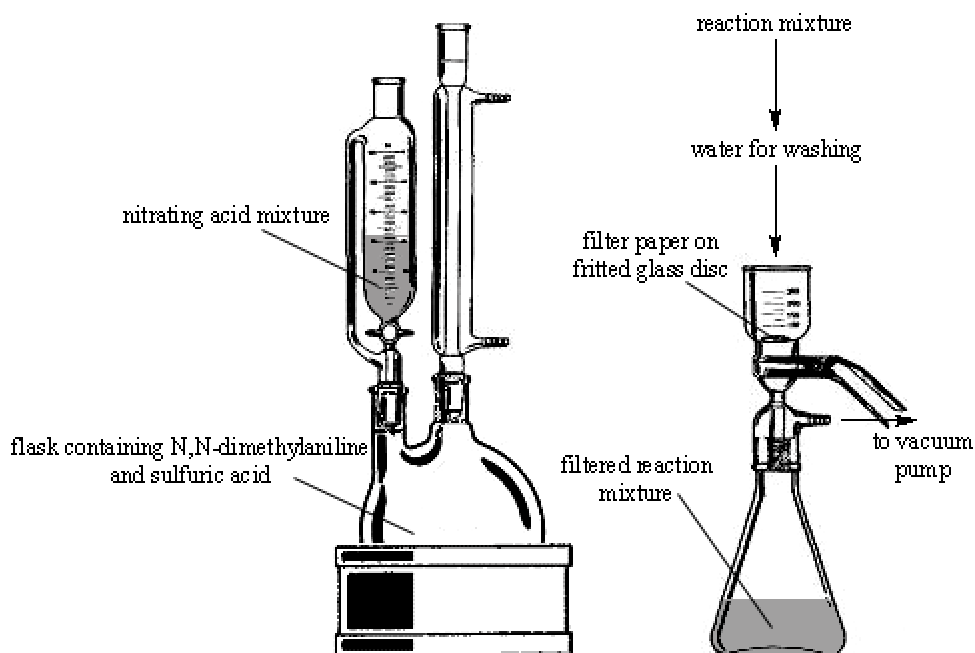
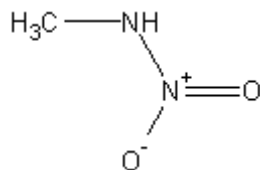

Figure 049. Apparatus for the preparation of tetryl. Left illustration: Reaction apparatus. Right illustration: The filtering process (vacuum filtering).

Notes:

Tetryl explosive composition "Tetratol"

Place 2400 grams of tetryl into a beaker, and then add 4-liters of water. Then add 2 grams of pentaerythritol dioleate, and manually stir the mixture for 10 minutes. Then add 100 grams wax 8 (Wax 8 is a composition of 15% low density polyethylene plus 85% wax 6, which is a microcrystalline hydrocarbon, commercially available), and manually blend the mixture at room temperature for 1 hour. After 1 hour, filter-off the explosive product, and then place the filtered-off product into a shallow tray and allow it to cure for 6 days at room temperature. After 6 days, press the explosive into any desirable mold, container, bomb casing, or warhead casing. When using tetratol as a booster, press the freshly prepared explosive composition into any desirable permanent container under mild pressure. Requires a blasting cap or detonator for initiation. Commercial & Industrial note: For related, or similar information, see Application No. 173,396, July 29, 1980, by The Secretary of State for Defence in Her Britannic Majesty's Government, London, GB2, to Alfred E. Painter, Bridgewater, GB2. Part or parts of this laboratory process may be protected by international, and/or commercial/industrial processes. Before using this process to legally manufacture the mentioned explosive, with intent to sell, consult any protected commercial or industrial processes related to, similar to, or additional to, the process discussed in this procedure. This process may be used to legally prepare the mentioned explosive for laboratory, educational, or research purposes.

8-04. MNA. Methylnitramine

MNA

Methylnitramine forms colorless to white crystals or a lightly colored solid—the crystals may have a flaky appearance. It is readily soluble in water, alcohol, chloroform, and benzene. The crystals have a melting point of about 40 Celsius, and hence, MNA is likely to encounter problems when used in high velocity projectiles, or artillery shells—MNA should be alloyed with a little RDX or TNT to render it acceptable for use in blasting cap base charges, or RDX free detonators. Methylnitramine is acidic and it readily forms primary explosives when treated with bases such as sodium or potassium hydroxide or metal carbonates—many of these salts are capable of self deflagration and can be used in fireworks, priming mixtures, initiating compositions, and the like. MNA does not decompose by boiling water, even if dilute alkalis are present, but it readily decomposes explosively in the presence of sulfuric acid.

Molecular weight: 76.055	Flammability: Burns with undo violence but may flash
Detonating velocity: Similar to RDX	Toxicity: Mild
Sensitivity: Low	Classification: Secondary explosive
Stability: Very good	Overall value (as secondary explosive): High

Procedure 8-04A: Preparation of MNA

Materials:	1. 81.2 grams dimethylurea
	2. 166 grams 70% nitric acid
	3. 260 grams 30% fuming sulfuric acid
	4. 800 milliliters methylene chloride
	5. 200 milliliters 14% sodium carbonate

Summary: MNA is prepared from dimethylurea by reaction with nitric and sulfuric acids. The resulting product is the high explosive dimethyldinitrourea. The dimethyldinitrourea is then hydrolyzed with water to yield methylnitramine. Commercial & Industrial note: For related, or similar information, see Application No. 394,084, July 1, 1982, by The United States Navy, to George W. Naufflett, Oxon Hill, MD. Part or parts of this laboratory process may be protected by international, and/or commercial/industrial processes. Before using this process to legally manufacture the mentioned explosive, with intent to sell, consult any protected commercial or industrial processes related to, similar to, or additional to, the process discussed in this procedure. This process may be used to legally prepare the mentioned explosive for laboratory, educational, or research purposes.

Hazards: Wear gloves when handling 70% nitric acid. 70% Nitric acid is a very corrosive acid that can cause severe skin burns. Use proper ventilation and wear gloves when handling 30% fuming sulfuric acid, which is a highly toxic liquid evolving toxic fumes of sulfur trioxide

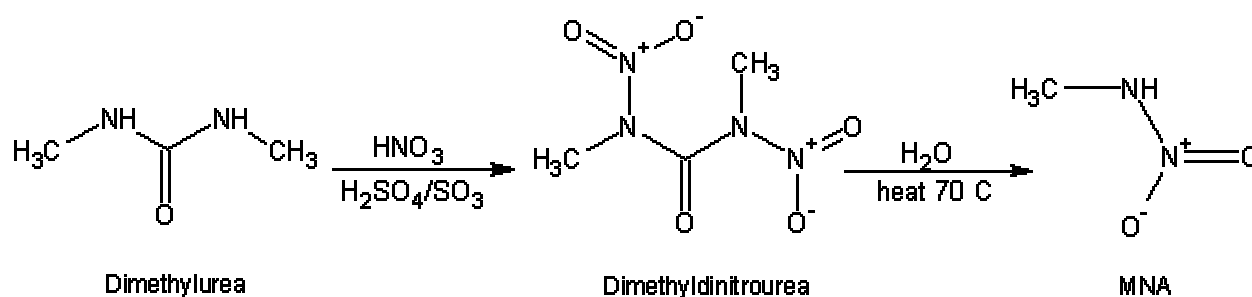

Reaction Equation

Procedure:

Step 1: Preparation of Dimethyldinitrourea

Dissolve 81.2 grams of 1,3-dimethylurea (DMU) into 160 milliliters of methylene chloride. Then prepare a nitrating acid mixture by mixing 260 grams of 30% fuming sulfuric acid with 166 grams 70% nitric acid (add the sulfuric to the nitric), and then cool this acid mixture to -5 Celsius. After which, slowly add the 1,3-dimethylurea/methylene chloride solution to the nitrating acid while rapidly stirring the nitrating acid, and maintaining the temperature of the nitrating acid at -5 Celsius. After the addition of the 1,3-dimethylurea/methylene chloride solution, add the reaction mixture to 100 milliliters of ice water. Then, drain-off the bottom acid layer to collect the upper methylene chloride layer using a separatory funnel, and then extract the drained-off bottom acid layer 1 time with 100 milliliters of methylene chloride. After extraction, drain-off the bottom acid layer to collect the upper methylene chloride layer using a separatory funnel. Afterwards, combine the two upper methylene chloride layers, and then mix thoroughly with 200 milliliters of 14% sodium carbonate solution while stirring. After which, drain-off the bottom methylene chloride layer using a separatory funnel, and then keep this methylene chloride layer for step 2.

Step 2: Hydrolysis of dimethyldinitrourea to yield methyl nitramine

Note: During the hydrolysis, no sulfuric acid should be present because methyl nitramine is decomposed by trace amounts of sulfuric acid.

Add the methylene chloride layer containing the dimethyldinitrourea (obtained in step 1) to 300 milliliters of water, and then reflux at 80 Celsius for 3 hours. After 3 hours, remove the heat source and allow the mixture to cool to room temperature. Afterwards, place the cooled mixture into a distillation apparatus and distill at 40 Celsius until no more methylene chloride is collected in the receiver flask (when the methylene chloride is gone, only a one liquid phase will remain). When the methylene chloride is gone, remove the heat source, and allow the remaining liquid in the distillation flask to cool to room temperature. The methyl nitramine remains in water solution, so keep for step 3.

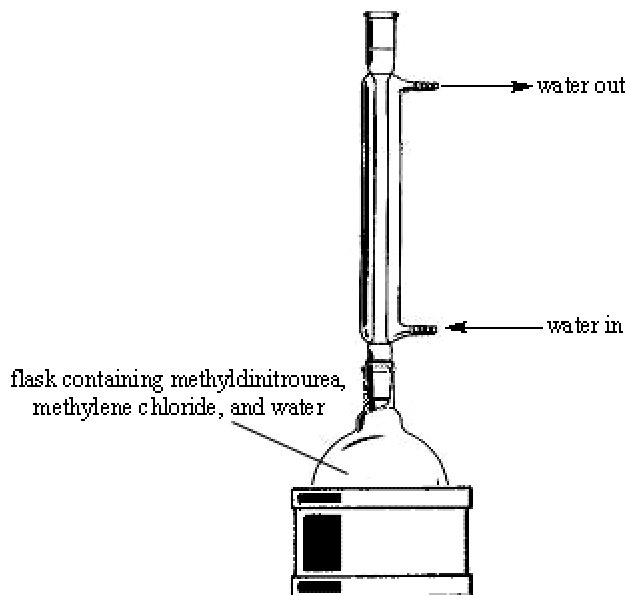

Figure 050. Set-up for step 2

Step 3: Separation of methylnitramine from water

Methylnitramine is highly soluble in water, and therefore, must be extracted with an organic solvent (see figure 051). To perform the extraction, vigorously shake the water solution of methylnitramine (obtained in step 2) with 180 milliliters of methylene chloride for several minutes, and then drain-off the bottom methylene chloride layer. Then, add 180 milliliters of methylene chloride to the upper water layer and shake the mixture vigorously for several minutes. Then drain-off the bottom methylene chloride layer. Finally, add 180 milliliters of methylene chloride to the upper water layer, and shake the mixture vigorously for several minutes. Then drain-off the bottom methylene chloride layer. Now, combine the three drained-off methylene chloride layers, and then place the methylene chloride into a distillation apparatus, and carefully distill at 40 Celsius until dry solid remains. If using a rotary evaporator, evaporate-off the methylene chloride under low vacuum. When dry solid remains, remove the heat source, and allow the dry product to cool to room temperature. Then collect the crystalline product from the distillation flask.

water solution of methylnitramine

methylene chloride

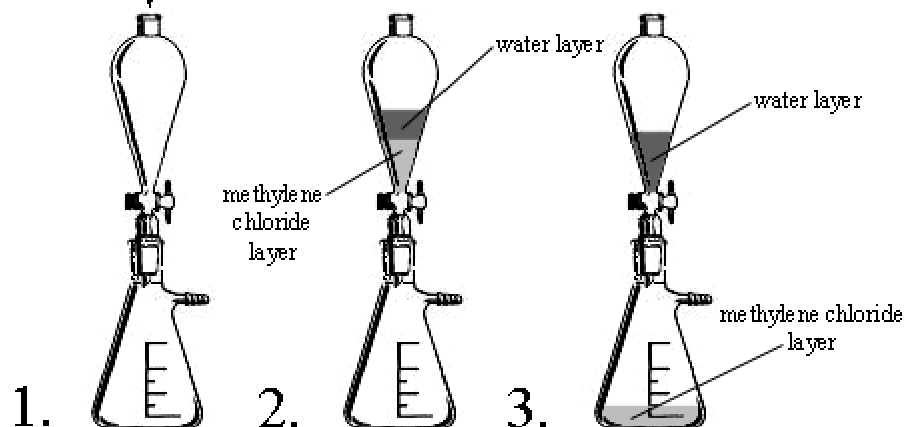

Figure 051. Set-up for step 3. The extraction process with methylene chloride

Note: Dimethyldinitrourea is also a high explosive, and should be handled with care. It can be used as a high explosive with properties ranging from MNA to DMMD—but it tends to be more difficult to handle, and readily decomposes at higher rates.

Note: Salts of methylnitramine can be prepared by mixing solutions of concentrated metal hydroxides or carbonates with the aqueous solution of MNA under mild conditions (room temperature, or less), and then adding acetone, alcohol, ethyl acetate, tetrahydrofuran, or other water soluble solvents to fully precipitate the metal salt. A variety of salts exist including the lithium, sodium, potassium, magnesium, iron, zinc, copper, aluminum, lead, and silver salts. The metal will be attached to the amine nitrogen (the nitrogen attached directly to the carbon).

Notes:

8-05. Methylene dinitramine

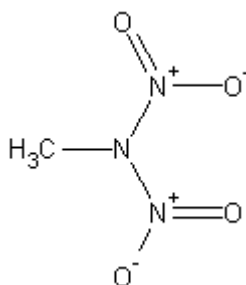

Methylene dinitramine

Uses: Substitute for MNA, main component of explosives composites, rocket propellants, and in the manufacture of other explosives.

Molecular weight: 118.028

Flammability: May burn or detonate when ignited

Detonating velocity: Similar to RDX

Toxicity: Mild

Sensitivity: Low	Classification: Secondary explosive
Stability: Very good	Overall value (as secondary explosive): Moderate

Procedure 8-05A: Preparation of Methylene dinitramine

Materials:	1. 760 milliliters of 99% nitric acid
	2. 204 grams of methylene diformamide
	3. 760 milliliters of acetic anhydride
	4. 200 milliliters of 99% formic acid
	5. 120 milliliters of benzene

Summary: Methylene dinitramine can be prepared by reacting methylene diformamide with 99% nitric acid in the presence of acetic anhydride. The reaction mixture is then treated with ice and water to precipitate the product. The product is then purified by dissolving it in formic acid. This formic acid mixture is allowed to stand for some time to collect a small amount of crystalline product that separates out. The mixture is then filtered, and the small amount of crystals that are collected will be used as seed crystals to induce recrystallization of the bulk of the product from the formic acid mixture. The filtered mixture is then heated to 65 Celsius, and then cooled to room temperature. After which, the mixture is placed into an ice bath, and then treated with some of the filtered-off crystalline product and allowed to stand for 6 hours. During the 6 hours, a slow recrystallization process takes place. After 6 hours, the mixture is filtered to remove the precipitated product, and then evaporated to half its volume. Afterwards, the mixture is seeded once more, and allowed to stand for another 6 hours to crystallize-out more of the product. The product is then washed with benzene, and dried. Commercial & Industrial note: For related, or similar information, see serial No. 400,375, December 24th, 1953, by Arthur D. Little, Cambridge, MA, to Charles W. Sauer. Part or parts of this laboratory process may be protected by international, and/or commercial/industrial processes. Before using this process to legally manufacture the mentioned explosive, with intent to sell, consult any protected commercial or industrial processes related to, similar to, or additional to, the process discussed in this procedure. This process may be used to legally prepare the mentioned explosive for laboratory, educational, or research purposes.

Hazards: Warning! Wear gloves and use proper ventilation when handling 99% nitric acid. 99% Nitric acid is a highly poisonous and corrosive liquid, which evolves highly poisonous fumes. Handle with care. Wear gloves when handling acetic anhydride and 98% formic acid, which can cause skin burns. Use proper ventilation when handling benzene. Benzene is a known carcinogen, and therefore prolonged exposure is not recommended.

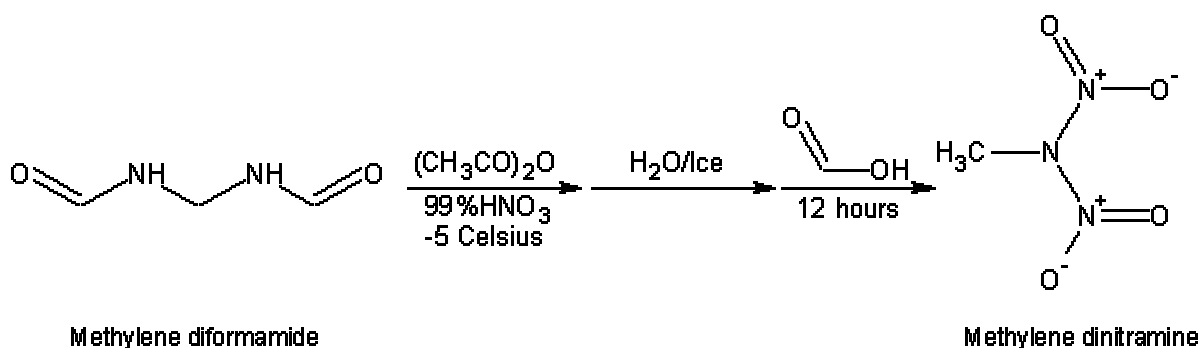

Reaction Equation

Procedure: Note: This procedure uses an excessive amount of 99% nitric acid to properly carry out the reaction. This excessive amount of acid can be recovered by treating the reaction mixture (after complete removal of the product) with methylene chloride to recover the nitric acid. Prior to this action, a small amount of sulfuric acid should be added to the reaction mixture. Afterwards, the reaction mixture should be extracted with several volumes of methylene chloride. These combined volumes can then be carefully distilled to recover the nitric acid of 99% purity (see nitric acid, 90% and 99% respectively).

Prepare a suspension of methylene diformamide in acetic anhydride by adding 204 grams of methylene diformamide to 760 milliliters of acetic anhydride while stirring the acetic anhydride. Then cool this mixture to -5 Celsius by means of an ice bath. Now, place 760 milliliters of 99% nitric acid into a flask, and cool to -5 Celsius by means of an ice bath. Afterwards, rapidly add the 99% nitric acid to the methylene diformamide suspension while maintaining the methylene diformamide suspension at -5 Celsius with rapid stirring. After the addition of the 99% nitric acid, continue stirring the reaction mixture at about -5

CHAPTER 8: THE PREPARATION OF NITRAMINES

Celsius for 4 hours. After 4 hours, add 1000 milliliters of cold water to a beaker, and then add 1 kilogram of ice. After which, slowly pour the entire reaction mixture over the ice while stirring the water and ice in the beaker. After adding all the reaction mixture to the ice water, allow the ice to melt, and then filter-off the precipitated product. Then wash this filtered-off product with six 100-milliliter portions of cold water. Then vacuum dry or air-dry the product. Then add the dry product to 200 milliliters of 98% formic acid while stirring the formic acid at room temperature, and then continue stirring for 12 hours. After 12 hours, filter-off the small amount of precipitated product that has crystallized out (this small amount of precipitated product will be used as seed crystals). After filtration, heat the mixture to 65 Celsius with stirring for 1 hour. After which, remove the heat source, and then filter the mixture hot (to remove any insoluble impurities). Thereafter, allow the filtered mixture to cool to room temperature. Then place the mixture into an ice bath, and then add the small amount of precipitated product collected earlier to act as seed crystals. Then allow the whole mixture to stand for about 6 hours with no stirring (this is to allow recrystallization). After 6 hours, filter-off the crystallized product, and then wash with 60 milliliters of benzene. Thereafter, vacuum dry or air-dry the product. Now, place the filtered mixture into a shallow pan with a high surface area, and allow the mixture to evaporate to half its original volume (blowing air over the surface will increase the evaporation. A small portable cooling fan can be used). When the mixture has been evaporated to half its original volume, place the mixture into an ice bath, and then add a small amount of the filtered-off dry crystalline product (to act as seeds crystals). Then allow the whole mixture to stand for 6 hours with no stirring (this is to allow crystallization). After 6 hours, filter-off the crystalline product, wash with 60 milliliters of benzene, and then vacuum dry or air-dry the product. Afterwards, both filtered-off crops of dry crystalline product can then be combined.

Notes:

8-06. HNIW. 2,4,6,8,10,12-hexanitro-2,4,6,8,10,12-hexaazaisowurtzitane

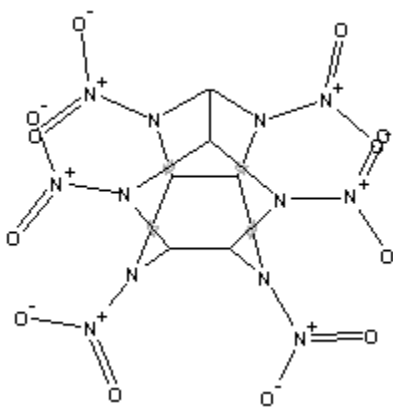

HNIW

HNIW has two modifications: alpha-modification forms colorless rhombic prisms, and the beta-modification forms colorless needles or chunky prisms. HNIW is an interesting explosive with a melting point of 260 Celsius (changes to gamma-modification at 185 Celsius and to the delta-modification at 230 Celsius). HNIW is a very powerful poly nitro explosive, but its high cost limits its use in military and commercial explosives—in the meantime. Nevertheless, its potential for growth is great as it has high resistance to shock, heat, friction, and percussion.

Molecular weight: 438.19	Flammability: Burns with smoky flame
Detonating velocity: 9380 (calculated)	Toxicity: Mild
Sensitivity: Very low (requires RDX detonator for initiation)	Classification: Secondary explosive
Stability: Very good	Overall value (as secondary explosive): High

Procedure 8-06A: Preparation of HNIW

CHAPTER 8: THE PREPARATION OF NITRAMINES

Materials:	1. 290 grams 40% glyoxal solution
	2. 471.6 grams benzylamine
	3. 23.04 grams of 88% formic acid solution
	4. 9700 milliliters acetonitrile
	5. 1000 milliliters acetic anhydride
	6. 75 grams 20% palladium on charcoal (pearlman's catalyst)
	7. 8.4 grams bromobenzene
	8. 11 liters chloroform
	9. 600 milliliters sulfolane
	10. 28.04 grams nitrosonium tetrafluoroborate
	11. 95.6 grams nitronium tetrafluoroborate
	12. 160 milliliters ethyl acetate

Summary: HNIW, 2,4,6,8,10,12-hexanitro-2,4,6,8,10,12-hexaazaisowurtzitane is prepared by reacting glyoxal with benzylamine and formic acid to yield 2,4,6,8,10,12-hexabenzyl-2,4,6,8,10,12-hexaazaisowurtzitane. This is then converted to 4,10-dibenzyl-2,6,8,12-tetraacetyl-2,4,6,8,10,12-hexaazaisowurtzitane by reaction with acetic anhydride in the presence of a palladium catalyst. The 4,10-dibenzyl-2,6,8,12-tetraacetyl-2,4,6,8,10,12-hexaazaisowurtzitane obtained, is then converted to HNIW by reaction with nitrosonium tetrafluoroborate, followed by nitronium tetrafluoroborate at low temperature. Commercial & Industrial note: For related, or similar information, see Application No. 253,106, September 30, 1988, by The United States Navy, to Arnold T. Nielsen, Santa Barbara, CA. Part or parts of this process may be protected by international, and/or commercial/industrial processes. Before using this process to legally manufacture the mentioned explosive, with intent to sell, consult any protected commercial or industrial processes related to, similar to, or additional to, the process discussed in this procedure. This process may be used to legally prepare the mentioned explosive for laboratory, educational, or research purposes.

Hazards: Wear gloves when handling nitrosonium tetrafluoroborate and nitronium tetrafluoroborate, which can both cause skin irritation. Wear gloves when handling acetic anhydride. Bromobenzene can cause eye and skin irritation. Wear gloves when handling 88% formic acid. 88% formic acid can cause skin burns, and local irritation. Use proper ventilation when handling ethyl acetate, which is a highly flammable volatile liquid.

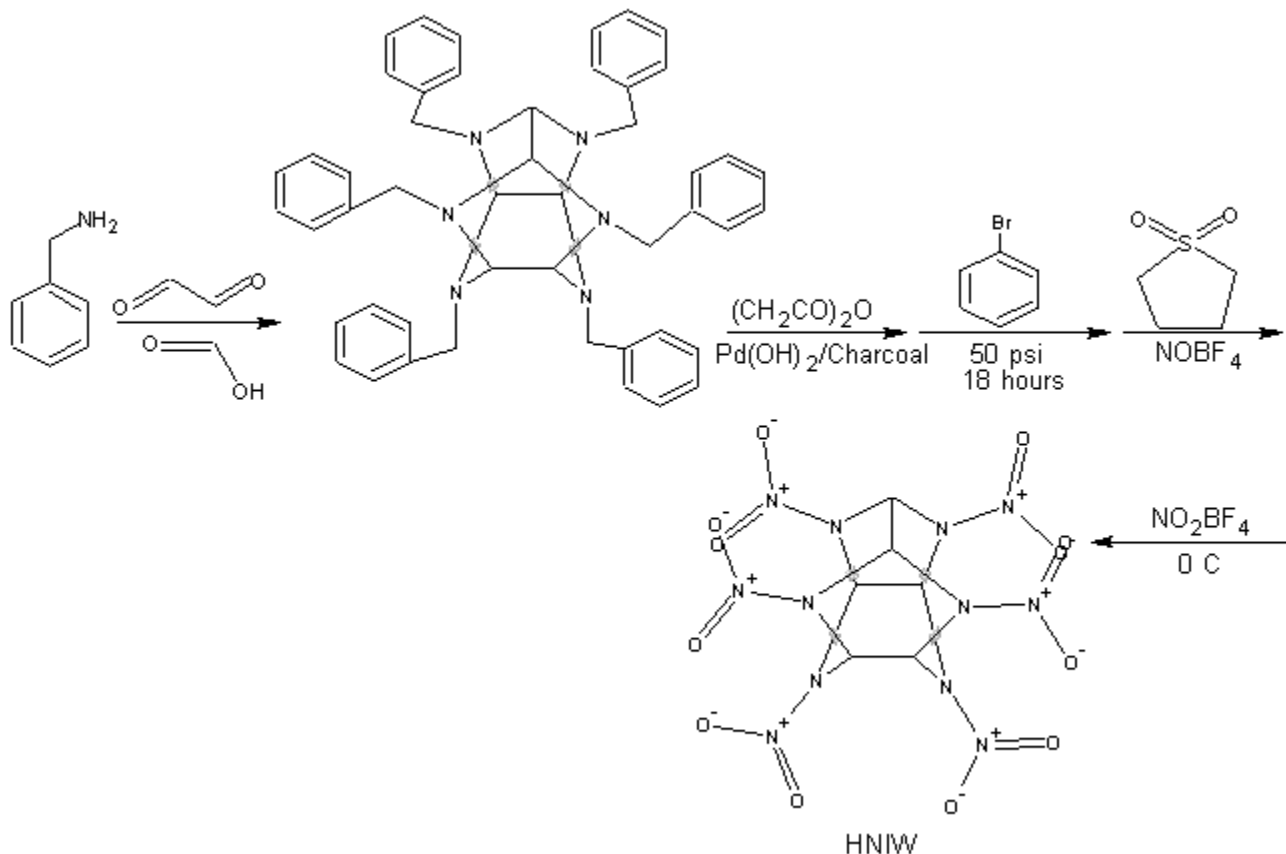

Reaction Equation

Procedure:**Step 1: Preparation of 2,4,6,8,10,12-hexabenzyl-2,4,6,8,10,12-hexaazaisowurtzitane (HBIW)**

Prepare a solution by adding 471.6 grams of benzylamine, 23.04 grams of 88% formic acid, and 400 milliliters of water into 4400 milliliters of acetonitrile, and then cool the mixture to 10 Celsius by the means of a cold-water bath. Then add 290 grams of a 40% glyoxal solution drop wise, over a 2-hour period while stirring the acetonitrile mixture. Keep the temperature of the mixture at 10 Celsius. After the addition, allow the reaction mixture to stand for 36 hours at room temperature. After which, filter-off the precipitated product, wash with 400 milliliters of cold acetonitrile, and then vacuum dry or air-dry the product. The yield will be 384 grams of 2,4,6,8,10,12-hexabenzyl-2,4,6,8,10,12-hexaazaisowurtzitane with a melting point of 152 Celsius.

Step 2: Preparation of 4,10-dibenzyl-2,6,8,12-tetraacetyl-2,4,6,8,10,12-hexaazaisowurtzitane (TAIW)

To a 5 liter Parr apparatus (special pressure reaction vessel; commercially available) place 4400 milliliters of acetonitrile, 300 grams of 2,4,6,8,10,12-hexabenzyl-2,4,6,8,10,12-hexaazaisowurtzitane (prepared in step 1), 1000 milliliters of acetic anhydride, 75 grams of 20% palladium hydroxide on charcoal catalyst (commercially available), and 8.4 grams of bromobenzene. Then turn the machine on, and shake the mixture at 50 psi for 36 hours at 10 Celsius. After 36 hours, remove the reaction mixture from the Parr apparatus, and then filter to remove the precipitated product. The precipitated product also contains the charcoal catalyst (save the filtered reaction mixture). After filtration, mix the filtered-off solids with 10 liters of boiling chloroform, and then stir the mixture for 20 minutes. Then filter the mixture hot to remove insoluble impurities. After which, recrystallize the product from the chloroform, and then vacuum dry or air-dry the product. Next, add the dry product to 300 milliliters of acetonitrile, and then stir the mixture for ten minutes at room temperature. Afterwards, filter the mixture to collect the insoluble product, and then vacuum dry or air-dry the product.

The filtered reaction mixture containing the 4400 milliliters of acetonitrile can be evaporated to yield more product. To do this, distill the acetonitrile at 82 Celsius until most of the acetonitrile is removed from the distillation flask (as the acetonitrile is distilled, temporarily stopping the distillation may be necessary in order to filter-off precipitated product). When the bulk of the acetonitrile (about 90%) has been distilled over, stop the distillation process, and allow the contents in the distillation flask

CHAPTER 8: THE PREPARATION OF NITRAMINES

to cool to room temperature. Then filter-off the precipitated product in the distillation flask if you have not done so at this time. Now, add the filtered-off solids to 200 milliliters of acetonitrile, and then stir the mixture for 20 minutes at room temperature. After 20 minutes, filter-off the insoluble product, and then vacuum dry or air-dry the product. The combined yield will be 138 grams of 4,10-dibenzyl-2,6,8,12-tetraacetyl-2,4,6,8,10,12-hexaazaisowurtzitane with a melting point of 315 to 325 Celsius.

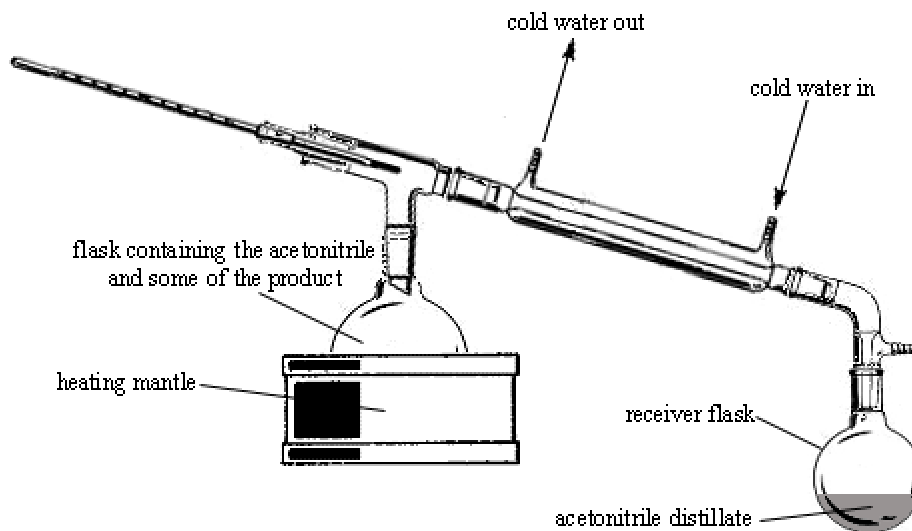

Figure 052. Apparatus for recovering acetonitrile

Step 3: Preparation of hexanitrohexaazaisowurtzitane 2,4,6,8,10,12-hexanitro-2,4,6,8,10,12-hexaazaisowurtzitane (HNIW)

To a 2 liter 3-neck flask, add 30.98 grams of 4,10-dibenzyl-2,6,8,12-tetraacetyl-2,4,6,8,10,12-hexaazaisowurtzitane (prepared in step 2), 2 milliliters of water, and 600 milliliters of sulfolane. Then cool the mixture to 10 Celsius by means of a cold-water bath. Then add 28.04 grams of nitrosonium tetrafluoroborate over a 60-minute time period while stirring, and keep the temperature of the reaction mixture to 10 Celsius. After addition of the nitrosonium tetrafluoroborate, remove the cold-water bath, and stir the reaction mixture at room temperature for one hour. After one hour, heat the reaction mixture to 60 Celsius, and maintain this temperature for 2 hours while stirring the reaction mixture. After 2 hours, cool the reaction mixture to room temperature. When the temperature reaches room temperature, place the reaction mixture into a cold-water bath, and then rapidly add 95.6 grams of nitronium tetrafluoroborate while keeping the temperature of the reaction mixture below 25 Celsius and stirring. After the addition, stir the reaction mixture at a temperature below 25 Celsius for 2 hours. After which, remove the cold water bath, and then heat the reaction mixture at 60 Celsius for 4 hours. After 4 hours, remove the heat source, and allow the reaction mixture to cool to room temperature. Afterwards, place the reaction mixture into a large beaker, and then place this beaker into an ice bath. Then, while stirring the contents of the beaker, slowly add 9 liters of water while keeping the temperature of the reaction mixture below 25 Celsius. During addition of the water, the mixture changes color to green, then yellow, and then brown fumes evolve (use proper ventilation). After addition of the water, remove the ice bath and allow the reaction mixture to stand at room temperature for 16 hours while stirring. After 16 hours, filter-off the precipitated product, wash with 400 milliliters of water, and then vacuum dry or air-dry the product to yield 25.56 grams of hydrated (1% water content) amorphous crude hexanitrohexaazaisowurtzitane (HNIW). Now, dissolve this product into 80 milliliters of ethyl acetate, and then pass this solution through a short silica gel column filled with silica gel (see figure 053). After passing the HNIW/ethyl acetate solution through the silica gel column, pass 80 milliliters of ethyl acetate through the silica gel column. The result will be a clear, pale-yellow solution. Then pour this clear, pale yellow solution into 1000 milliliters of chloroform, which will cause precipitation of the HNIW product. Then filter-off this precipitated product, and then vacuum dry or air-dry the product. The result will be 23.8 grams of pure dry hexanitrohexaazaisowurtzitane (HNIW) in the anhydrous beta-crystalline form, composed of small rhombic crystals with a melting point of 260 Celsius (with decomposition).

CHAPTER 8: THE PREPARATION OF NITRAMINES

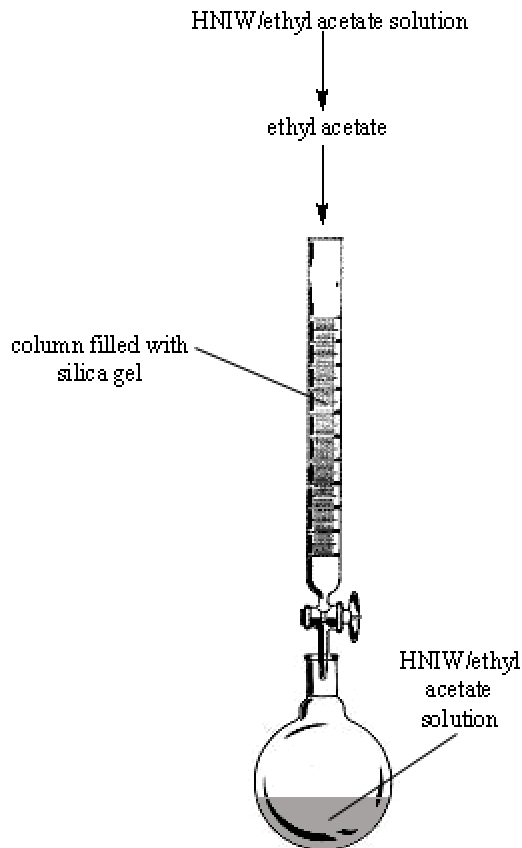

Figure 053. Method of purification using silica gel as absorbent

Note: Occasionally during the addition of the 9 liters of water, a disulfolane adduct of hexanitrohexaazaisowurtzitane is formed in the form of very pale yellow crystals with a melting point of 92 to 100 Celsius.

This disulfolane adduct can be decomposed by heating with 30 milliliters of distilled water per 2 grams of disulfolane adduct while stirring the mixture at 95 Celsius for 20 minutes. After 20 minutes, remove the heat source, and allow the mixture to cool to room temperature. Afterwards, place the mixture in an ice bath for one hour. After 1 hour, remove the ice bath, and allow the mixture to warm to room temperature. Then allow the mixture to stand for 6 hours at room temperature. Afterwards, filter-off the insoluble product, and then wash the filtered-off product with 400 milliliters of water followed by vacuum drying or air-drying to yield amorphous crude hydrated hexanitrohexaazaisowurtzitane (HNIW) (1% water content). Then dissolve this product into 80 milliliters of ethyl acetate, and then pass this solution through a short silica gel column filled with silica gel. Then pass 80 milliliters of ethyl acetate through the silica gel column. This will yield a clear, pale-yellow solution. Next, pour this clear, pale-yellow solution into 1000 milliliters of chloroform, which causes the product to precipitate. Then filter-off this precipitated product, and then vacuum dry or air-dry the product. The result will be 23.8 grams of pure dry hexanitrohexaazaisowurtzitane (HNIW) in the anhydrous beta-crystalline form composed of small rhombic crystals with a melting point of 260 Celsius (with decomposition).

Notes:

CHAPTER 9: THE PREPARATION OF NITRAMINE SALTS

ADN, KDN

9-01. ADN. *Ammonium dinitramide*

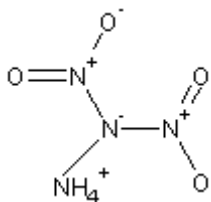

ADN

ADN is a relatively new high-energy compound that has great interest and future potential. The potassium salt of ADN was first synthesized in 1971, and since then the research into ADN and its salts has expanded—many other salts have been prepared. ADN forms colorless to white to lightly yellowish crystals, which are more than adequate for replacing ammonium perchlorate in high performance solid rocket propellants. ADN shows great importance for rocket propellants and high performance gun propellants as it increases overall thrust, and decreases smoke and flash emissions. It also shows potential for clean burning firework and other pyrotechnic compositions.

Molecular weight: 124.056	Flammability: Highly flammable
Detonating velocity: Uncalculated	Toxicity: Mild
Sensitivity: Moderate	Classification: Secondary explosive
Stability: Good	Overall value (as secondary explosive): Very high

Procedure 9-01A: Preparation of ADN

Materials:	1. 100 grams 33% nitric acid solution
	2. 28 grams urea
	3. 168 milliliters 98% sulfuric acid
	4. 40.94 grams nitronium tetrafluoroborate
	5. 20 to 30 grams anhydrous ammonia
	6. 200 milliliters acetonitrile
	7. 200 milliliters ethyl acetate
	8. 200 milliliters chloroform

Summary: ADN is manufactured by converting urea to urea nitrate followed by treatment with concentrated sulfuric acid to form nitrourea. Nitrourea is then reacted with nitronium tetrafluoroborate to form the ADN intermediate. This intermediate is directly converted into ADN by treatment with ammonia gas. Urea is a by-product, and hence can be recycled. Commercial & Industrial note: For related, or similar information, see Application No. 653,833, May 28, 1996, by Nissan Motor Co., Ltd. Kanagawa, JP, Hosoya Fireworks Co., Ltd. Tokyo, JP, to Shigeru Suzuki, Saitama-ken, JP, Shigefumi Miyazaki, Saitama-ken, JP, Hideo Hatano, Akigawa, JP, Kazuo Shiino, Akigawa, JP, and Toshio Onda, Akigawa, JP. Part or parts of this laboratory process may be protected by international, and/or commercial/industrial processes. Before using this process to legally manufacture the mentioned explosive, with intent to sell, consult any protected commercial or industrial processes related to, similar to, or additional to, the process discussed in this procedure. This process may be used to legally prepare the mentioned explosive for laboratory, educational, or research purposes.

Hazards: Wear gloves when handling 98% sulfuric acid. 98% sulfuric can cause sever skin burns. Use caution when handling nitronium tetrafluoroborate.

CHAPTER 9: THE PREPARATION OF NITRAMINE SALTS

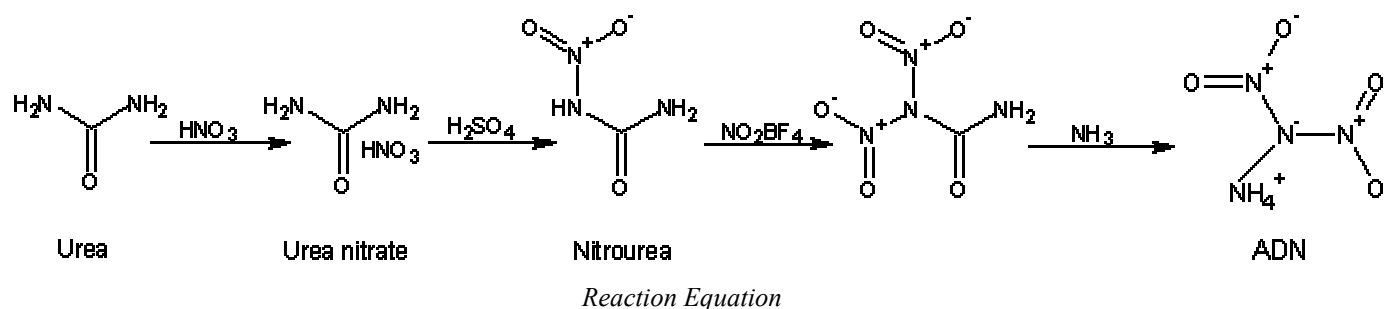

Procedure:

Step 1: Preparation of urea nitrate

To a 200-milliliter beaker place 100 grams of 33% diluted nitric acid, and then add 28 grams of urea in small portions while stirring the 33% nitric acid vigorously. During the addition of the urea, the reaction temperature does not show any practical rise, so this reaction can be carried out at room temperature without cooling means. Immediately upon addition, urea nitrate forms as crystals. After the addition of the urea, allow the reaction mixture to stand for 20 minutes, and then filter the mixture to collect the urea nitrate crystals. Wash the crystals with 100 milliliters of cold water, and then vacuum dry or air-dry. The yield will be 47.6 grams of urea nitrate with a melting point of 162 Celsius.

Step 2: Preparation of nitro urea

Place 168 milliliters of 98% sulfuric acid into a 400-milliliter 3-necked flask, which is equipped with a thermometer, and stirrer. Then cool the flask to -5 Celsius by means of an ice/salt bath. Then add and dissolve in small portions, 47.6 grams of urea nitrate (prepared in step 2) while stirring the 98% sulfuric acid. After the addition of the urea nitrate, stir the mixture for an additional 1 hour, and then pour the entire reaction mixture onto 300 grams of crushed ice contained in a beaker. After the ice melts, collect the crystals of nitrourea by filtration. After which, wash the crystals with 100 milliliters of ice cold water, and then vacuum dry or air-dry. The yield will be 32.4 grams of nitrourea with a melting point of 159 Celsius. Note: Since nitrourea dissolves easily in water, the yield is improved more by taking sufficient care when washing with cold water.

Step 3: Preparation of ADN

Mix the nitrourea (prepared in step 2) with 200 milliliters of acetonitrile, and then cool the mixture with an ice bath while stirring vigorously. To this stirred solution, gradually add 40.94 grams of the nitration reagent, nitronium tetrafluoroborate. In a short time, the solution becomes clear. After addition of the nitronium tetrafluoroborate, let the reaction mixture stand for about 1 hour. After this 1-hour period, pass 20 to 30 grams of ammonia gas into the reaction mixture. Stop the addition of the ammonia gas when the odor of ammonia can be detected. After the addition of ammonia, filter-off the by-product solids. Now, evaporate the filtered reaction mixture to concentrate it (no heat; preferably use a rotary evaporator if available). To concentrate the reaction mixture, evaporate the reaction mixture up-to-the-point where a very small amount of solid begins to precipitate. When a small amount of solid begins to precipitate, stop the evaporation process, and then mix the reaction mixture with 200 milliliters of ethyl acetate and stir for 2 minutes. After adding the ethyl acetate, if any precipitate is formed, filter it off because it will be by-product solids. Then concentrate the reaction mixture by evaporation in the same manner as before (no heat; preferably use a rotary evaporator if available). During the evaporation of the reaction mixture, when a tiny amount of solid begins to precipitate, stop the evaporation and then add 200 milliliters of chloroform. After the addition of the chloroform, filter-off the precipitated product, and then vacuum dry or air-dry.

Note: Many other salts of ADN can be prepared by replacing dry ammonia gas with another base such as metal hydroxides or carbonates—preferably carbonates rather than hydroxides as strong hydroxides may decrease yields as the result of hydrolysis.

Notes:

Procedure 9-01B: Preparation of ADN

CHAPTER 9: THE PREPARATION OF NITRAMINE SALTS

Materials:	1. 250 milliliters acetonitrile
	2. 30 grams of nitronium tetrafluoroborate
	3. 8 grams of ammonium carbamate
	4. 480 milliliters isopropyl alcohol
	5. 26 grams anhydrous ammonia
	6. 2 liters diethyl ether
	7. 50 milliliters of acetone
	8. 50 milliliters of ethyl acetate
	9. 20 milliliters of butanol

Summary: ADN can be prepared directly from ammonium carbamate by first, reacting the carbamate with nitronium tetrafluoroborate in the presence of acetonitrile to form an intermediate, the free acid of ADN, which need not be isolated. This intermediate is then treated with an alcoholic solution of ammonia in the presence of ether. The ADN, is then recovered by evaporation of the reaction mixture, followed by treatment with a solvent mixture, to remove impurities. The product is recovered by evaporation, and then recrystallized from butanol to form high purity ADN. Commercial & Industrial note: For related, or similar information, see Application No. 539,647, June 18th, 1990, by SRI International, to Jeffrey C. Bottaro, Mountain View, CA, Robert J. Schmitt, Redwood City, CA, Paul E. Penwell, Menlo Park, CA, and David S. Ross, Palo Alto, CA. Part or parts of this laboratory process may be protected by international, and/or commercial/industrial processes. Before using this process to legally manufacture the mentioned explosive, with intent to sell, consult any protected commercial or industrial processes related to, similar to, or additional to, the process discussed in this procedure. This process may be used to legally prepare the mentioned explosive for laboratory, educational, or research purposes.

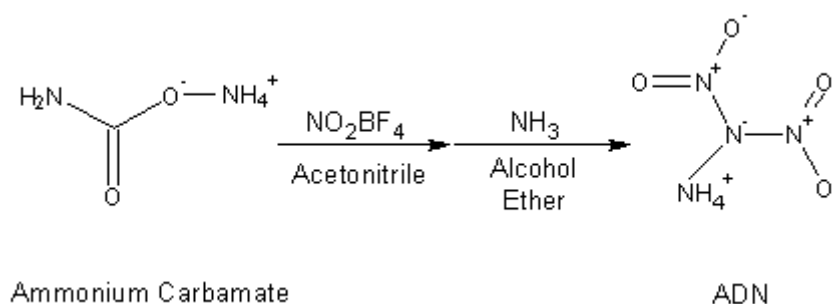
Reaction Equation

Hazards: Wear gloves when handling nitronium tetrafluoroborate, which can cause skin burns and throat irritation if inhaled. Use proper ventilation when handling acetonitrile, acetone, and diethyl ether, all of which are highly flammable. Avoid inhalation of ether vapors, and perform the peroxide test before using.

Procedure: Add and dissolve 30 grams of nitronium tetrafluoroborate into 250 milliliters of acetonitrile, and then cool the mixture to -20 Celsius by means of a dry ice/acetone bath. Thereafter, gradually add 8 grams of ammonium carbamate over a period of time sufficient to keep the temperature of the nitronium tetrafluoroborate at -20 Celsius. During the addition, rapidly stir the acetonitrile. After the addition, stir the reaction mixture for 60 minutes at -20 Celsius. During the 60 minute stirring period, prepare a mixture by adding and dissolving 26 grams of anhydrous ammonia into 480 milliliters of isopropyl alcohol, and then add this ammonia solution to 2 liters of diethyl ether and stir the mixture rapidly for several minutes. Then, after the 60-minute heating period of the nitronium tetrafluoroborate/ammonium carbamate mixture, add this nitronium tetrafluoroborate mixture into the ammonia/diethyl ether mixture while stirring the ammonia/diethyl ether mixture rapidly. After the addition, continue to stir for about 50 minutes. After 50 minutes, stop stirring, and then place the mixture into a rotary evaporator, and evaporate the reaction mixture to dryness. Afterwards, remove the dry solid from the rotary evaporator and then dissolve into a solvent mixture prepared by mixing 50 milliliters of acetone with 50 milliliters of ethyl acetate with stirring. Thereafter, filter-off any insoluble impurities, and then place the filtered liquid into a clean rotary evaporator, and evaporate the filtered mixture to dryness. After which, remove the dry product from the rotary evaporator, and then recrystallize the dry product from 20 milliliters of butanol. The collected solid is then dried under vacuum to yield 1.5 grams of high purity ammonium dinitramide.

Notes:

Procedure 9-01C: Preparation of ADN

Materials:	1. 10 grams of KDN
	2. 10 grams of ammonium sulfate
	3. 500 milliliters isopropyl alcohol
	4. 300 milliliters petroleum ether

Summary: ADN is easily prepared by mixing a solution of KDN in water, with a solution of ammonium sulfate in water. The resulting mixture is then treated with alcohol, evaporated, and then re-treated with alcohol followed by re-evaporation.

Commercial & Industrial note: For related, or similar information, see Serial No. 983,462, January 13, 1998, by Forsvarets Forskningsanstalt, to Abraham Langlet, Stockholm, SE, Henric Ostmark, Huddinge, SE, and Niklas Wingborg, Stockholm, SE. Part or parts of this laboratory process may be protected by international, and/or commercial/industrial processes. Before using this process to legally manufacture the mentioned explosive, with intent to sell, consult any protected commercial or industrial processes related to, similar to, or additional to, the process discussed in this procedure. This process may be used to legally prepare the mentioned explosive for laboratory, educational, or research purposes.

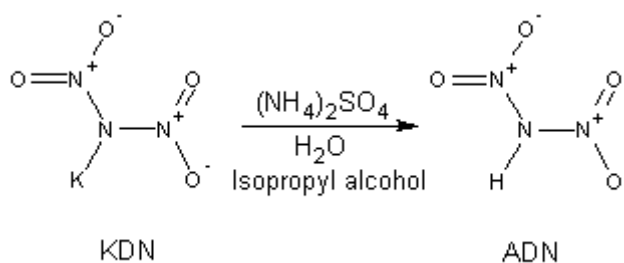

Reaction Equation

Hazards: Petroleum ether is flammable, extinguish all flames before use, and avoid inhalation of vapors.

Procedure: Dissolve 10 grams of KDN into 20 milliliters of water. Then prepare a second solution by dissolving 10 grams of ammonium sulfate into 20 milliliters of water. Thereafter, mix these two solutions with stirring. A white precipitate of potassium sulfate will immediately form. After mixing both solutions, stir the reaction mixture for several minutes. After which, add 200 milliliters of isopropyl alcohol, and stir the mixture for several minutes. Then, filter-off the precipitated potassium sulfate, and then place the filtered reaction mixture into a rotary evaporator and evaporate-off the isopropyl alcohol under vacuum. If a rotary evaporator is unavailable, place the reaction mixture into a shallow pan, and then blow air over the surface until a moist solid remains. When a moist solid is obtained, collect the moist solid, and then re-dissolve into 300 milliliters of isopropyl alcohol. Thereafter, add 300 milliliters of petroleum ether and stir the mixture for several minutes. After which, filter-off the precipitated ADN, and then vacuum dry or air-dry the solid.

Notes:

9-02. KDN. *Potassium dinitramide*

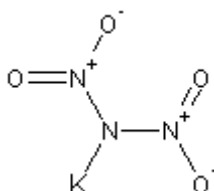

CHAPTER 9: THE PREPARATION OF NITRAMINE SALTS
KDN

Uses: see ADN.

Molecular weight: 145.117	Flammability: Highly flammable—self deflagrates
Detonating velocity: Uncalculated	Toxicity: Mild
Sensitivity: Moderate	Classification: Secondary explosive
Stability: Good	Overall value (as secondary explosive): High

Procedure 9-02A: Preparation of KDN

Materials:	1. 30 grams nitronium tetrafluoroborate
	2. 250 milliliters of acetonitrile
	3. 8 grams ammonium carbamate
	4. 208 grams potassium carbonate
	5. 2 liters diethyl ether
	6. 50 milliliters of acetone
	7. 50 milliliters ethyl acetate
	8. 20 milliliters butanol

Summary: KDN can be prepared directly from ammonium carbamate by first, reacting the carbamate with nitronium tetrafluoroborate in the presence of acetonitrile to form an intermediate, the free acid of ADN, which need not be isolated. This intermediate is then treated with a potassium carbonate solution in the presence of ether. The KDN is then recovered by evaporation of the reaction mixture, followed by treatment with a solvent mixture, to remove impurities. The product is recovered by evaporation, and then recrystallized from butanol to form high purity KDN. Commercial & Industrial note: For related, or similar information, see Application No. 539,647, June 18, 1990, by SRI International, to Jeffrey C. Bottaro, Mountain View, CA, Robert J. Schmitt, Redwood City, CA, Paul E. Penwell, Menlo Park, CA, and David S. Ross, Palo Alto, CA. Part or parts of this laboratory process may be protected by international, and/or commercial/industrial processes. Before using this process to legally manufacture the mentioned explosive, with intent to sell, consult any protected commercial or industrial processes related to, similar to, or additional to, the process discussed in this procedure. This process may be used to legally prepare the mentioned explosive for laboratory, educational, or research purposes.

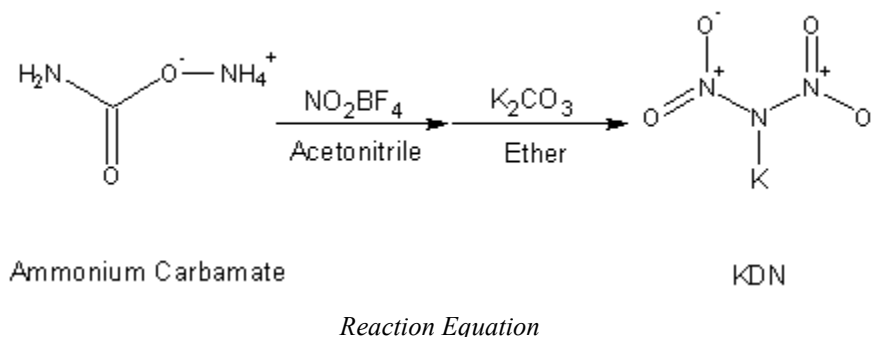

Hazards: Wear gloves when handling nitronium tetrafluoroborate, which can cause skin burns and throat irritation if inhaled. Use proper ventilation when handling acetonitrile, acetone, and diethyl ether, all of which are highly flammable. Avoid inhalation of ether vapors, and perform the peroxide test before using.

Procedure: Add and dissolve 30 grams of nitronium tetrafluoroborate into 250 milliliters of acetonitrile, and then cool the mixture to -20 Celsius by means of a dry ice/acetone bath. Thereafter, gradually add 8 grams of ammonium carbamate over a period of time sufficient to keep the temperature of the nitronium tetrafluoroborate at -20 Celsius. During the addition, rapidly stir the acetonitrile. After the addition, stir the reaction mixture for 60 minutes at -20 Celsius. During the 60-minute stirring period, prepare a mixture by adding and dissolving 208 grams of potassium carbonate into 420 milliliters of warm water, and then add this solution to 2 liters of diethyl ether with rapid stirring of the ether. Then, after the 60-minute heating period of the nitronium tetrafluoroborate/ammonium carbamate mixture, add this nitronium tetrafluoroborate mixture into the potassium carbonate/diethyl ether mixture while stirring the potassium carbonate/diethyl ether mixture rapidly. After the addition, continue to stir for about 50 minutes. After 50 minutes, stop stirring, and then place the mixture into a rotary evaporator, and evaporate the reaction mixture to dryness. Afterwards, remove the dry solid from the rotary evaporator and then dissolve into a solvent mixture prepared by mixing 50 milliliters of acetone with 50 milliliters of ethyl acetate with stirring. Thereafter, filter-

CHAPTER 9: THE PREPARATION OF NITRAMINE SALTS

off any insoluble impurities, and then place the filtered liquid into a clean rotary evaporator, and evaporate the filtered mixture to dryness. After which, remove the dry product from the rotary evaporator, and then recrystallize the dry product from 20 milliliters of butanol. The collected solid is then dried under vacuum to yield 1.5 grams of high purity potassium dinitramide.

Notes:

Procedure 9-02B: Preparation of KDN

Materials:	1. 140.7 grams sulfamic acid
	2. 106 grams potassium hydroxide
	3. 528 milliliters 95% ethanol
	4. 90 milliliters 90% nitric acid
	5. 32 milliliters 98% sulfuric acid
	6. 20 milliliters acetone
	7. 200 milliliters of isopropyl alcohol

Summary: KDN is conveniently prepared from sulfamic acid, by first, converting the free acid to its potassium salt, and then nitrating this potassium salt with 90% nitric acid in the presence of concentrated sulfuric acid. The resulting free acid of ADN, is then immediately neutralized with potassium hydroxide. The resulting mixture is then evaporated, treated with solvents, and then precipitated to yield good purity KDN. Commercial & Industrial note: For related, or similar information, see Serial No. 983,462, January 13, 1998, by Forsvarets Forskningsanstalt, to Abraham Langlet, Stockholm, SE, Henric Ostmark, Huddinge, SE, and Niklas Wingborg, Stockholm, SE. Part or parts of this laboratory process may be protected by international, and/or commercial/industrial processes. Before using this process to legally manufacture the mentioned explosive, with intent to sell, consult any protected commercial or industrial processes related to, similar to, or additional to, the process discussed in this procedure. This process may be used to legally prepare the mentioned explosive for laboratory, educational, or research purposes.

Hazards: Use proper ventilation and wear proper lab clothing when handling 90% nitric acid and 98% sulfuric acid. 90% Nitric acid is a highly toxic, and corrosive liquid which evolve highly poisonous fumes of nitrogen oxides. Use great care. Extinguish all flames before using acetone, which is highly volatile and flammable.

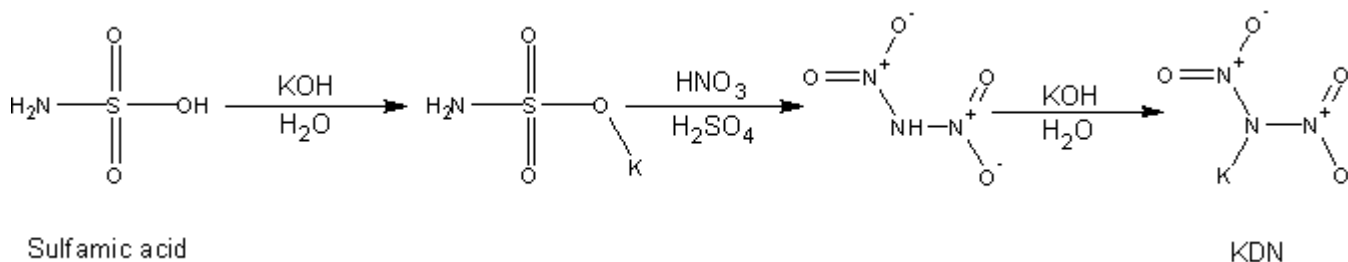

Reaction Equation

Procedure:

Step 1: Preparation of the potassium salt of Sulfamic Acid

Prepare a suspension by adding 140.7 grams of sulfamic acid into 100 milliliters of water. Prepare a second mixture by dissolving 88 grams of potassium hydroxide into 100 milliliters of water. Thereafter, add the potassium hydroxide solution to the sulfamic acid suspension with rapid stirring. After which, pour the entire mixture into 428 milliliters of 95% ethanol while stirring the ethanol. After which, filter-off the precipitated potassium salt of sulfamic acid, wash with 100 milliliters of 95% ethanol, several times, using the same washing portion, and then vacuum dry or air-dry the product. After the product has been sufficiently dried, grind it up into a fine powder for use in step 2.

Step 2: Preparation of potassium dinitramide

CHAPTER 9: THE PREPARATION OF NITRAMINE SALTS

Place 90 milliliters of 90% nitric acid into a beaker, and then add 32 milliliters of 98% sulfuric acid. Thereafter, cool the acid mixture to -30 Celsius by mean of a dry ice/acetone bath. Then, carefully, and gradually add 34 grams of the potassium salt of sulfamic acid (prepared in step 1), in 1 gram portions, to the nitrating acid mixture over a period of about 40 minutes. During the addition, rapidly stir the nitrating acid mixture and maintain its temperature at -30 Celsius. After the addition (40 minutes), immediately pour the entire reaction mixture into a beaker filled with 300 grams of crushed ice and 300 milliliters of water. Immediately thereafter, place this ice water mixture into a dry ice/acetone bath, and then rapidly add 18 grams of a cold potassium hydroxide solution prepared by dissolving 18 grams of potassium hydroxide into 40 milliliters of ice-cold water. During the potassium hydroxide addition, rapidly stir the reaction mixture while keeping its temperature below 0 Celsius. Note: the solution should turn a greenish-yellow color. After the addition of the potassium hydroxide, place the reaction mixture into a rotary evaporator, and evaporate-off the water under vacuum until dry solid remains. If rotary evaporator is unavailable, place the reaction mixture into a shallow pan, and then blow air over the surface until dry solid remains. When dry solid remains, recover the dry solid, and then mix with 20 milliliters of acetone, and then add 200 milliliters of isopropyl alcohol. Then stir the mixture rapidly for several minutes. After which, place the mixture into a clean rotary evaporator, and evaporate-off the acetone, and some of the isopropyl alcohol under vacuum. If a rotary evaporator is unavailable, place the mixture into a distillation apparatus, and carefully distill-off the acetone and some of the isopropyl alcohol. Once the acetone has been removed, stop the evaporation, and then cool the mixture to room temperature. When the acetone is removed, the KDN will precipitate. Thereafter, filter-off the precipitated KDN, and then vacuum dry or air-dry the product. The result will be about 21.4 grams of relatively pure KDN.

Notes:

CHAPTER 10: THE PREPERATION OF AMINO NITRO BENZENES

TETRANILINE, TATB, DATB, DATBA, A-NPNT, UDTNB, DNPU, ADNBF, TNPU

10-01. Tetraniline. *Tetranitro aniline*

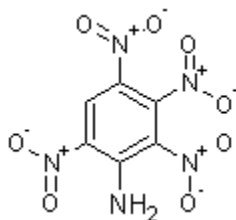

Tetraniline

Tetraniline is a yellow crystalline solid with a melting point of 210 Celsius. It is readily soluble in acetone, but only slightly soluble in acetic acid, benzene, and chloroform—it is insoluble in water. Tetraniline is a powerful explosive used in the preparation of priming compositions, initiating mixtures for blasting caps, substitute for lead azide, boosters, and explosive compositions. It is easily reduced in acetone solution with strong base yielding 2,4,6-trinitrobenzene-1,3-diamine (DATB).

Molecular weight: 273.117	Flammability: Flashes when ignited
Detonating velocity: Similar to TNT	Toxicity: Moderate
Sensitivity: Moderate	Classification: Primary explosive
Stability: Very good	Overall value (as primary explosive): Moderate

Procedure 10-01A: Preparation of Tetraniline

Materials:	1. 72 grams 98% sulfuric acid
	2. 5 grams sodium nitrate
	3. 2 grams of meta-nitroaniline (can be prepared by careful nitration of aniline with 70% nitric acid).

Summary: Tetraniline is prepared by the reaction of meta-nitroaniline with sodium nitrate in concentrated sulfuric acid. The resulting mixture is then heated. After which, the heat is removed, and the reaction mixture allowed to cool to room temperature. The precipitated product is then filtered-off, washed, and dried. Commercial & Industrial note: Part or parts of this laboratory process may be protected by international, and/or commercial/industrial processes. Before using this process to legally manufacture the mentioned explosive, with intent to sell, consult any protected commercial or industrial processes related to, similar to, or additional to, the process discussed in this procedure. This process may be used to legally prepare the mentioned explosive for laboratory, educational, or research purposes.

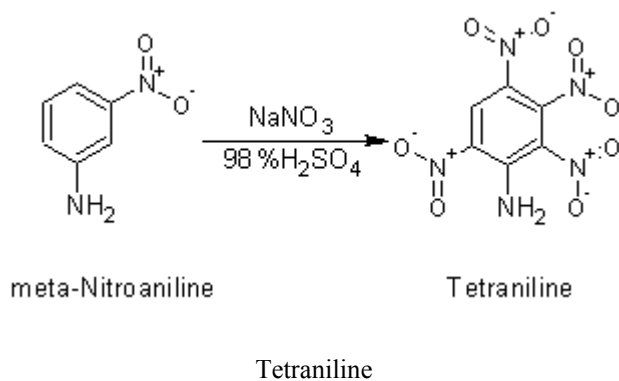

Hazards: Wear gloves when handling 98% sulfuric acid, and meta-nitroaniline. Meta-Nitroaniline is toxic, and can be absorbed through the skin.

CHAPTER 10: THE PREPERATION OF AMINO NITRO BENZENES

Procedure: Into a suitable beaker, place 72 grams of 98% sulfuric acid. Then add 2 grams of meta-nitroaniline, and 5 grams of sodium nitrate. Then heat the mixture to 70 Celsius, and rapidly stir. During the heating process an exotherm will result, so keep the temperature from rising above 90 Celsius. Frequent stopping and starting of the heat source may be needed in order to control the reaction temperature. When the exotherm has subsided, the reaction has ceased. Thereafter, heat the mixture with stirring at 100 Celsius for about 10 minutes, and then remove the heat source, and allow the reaction mixture to cool to room temperature. Afterwards, filter-off the precipitated product, and then wash with a large amounts of cold water. Do not wash with alkali, as reduction of the fourth nitro group may result. After washing, vacuum dry or air-dry the product.

Notes:

Procedure 10-01B: Preparation of Tetraniline

Materials:	1. 2000 milliliters of 98% sulfuric acid
	2. 570 grams of 99% nitric acid
	3. 214 grams of meta-nitroaniline (can be prepared by careful nitration of aniline with 70% nitric acid).
	4. 500 milliliters of 50% sulfuric acid

Summary: Tetraaniline can be prepared by nitrating meta-nitroniline with anhydrous nitric acid in the presence of concentrated sulfuric acid. The resulting reaction mixture is then stirred, and the desired product allowed to precipitate. The precipitated product is then filtered-off, washed with acid, and then with water. The moist product is then vacuum dried or air-dried. Commercial & Industrial note: For related, or similar information, see Application No. 701,582, May 14, 1991, by Rockwell International Corporation, to James F. Weber, Moorpark, CA. Part or parts of this laboratory process may be protected by international, and/or commercial/industrial processes. Before using this process to legally manufacture the mentioned explosive, with intent to sell, consult any protected commercial or industrial processes related to, similar to, or additional to, the process discussed in this procedure. This process may be used to legally prepare the mentioned explosive for laboratory, educational, or research purposes.

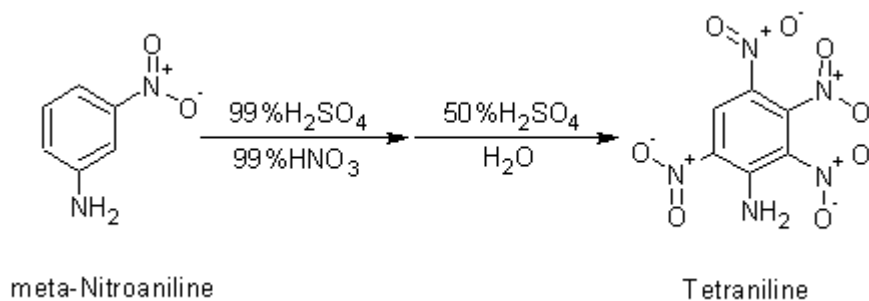

Reaction Equation

Hazards: Wear gloves and use maximum ventilation when handling 99% nitric acid. 99% nitric acid is highly toxic, and corrosive liquid, which emits highly poisonous fumes of nitrogen oxides. Use great care. Wear gloves when handling 98% sulfuric acid, and meta-nitroaniline. Meta-Nitroaniline is toxic, and can be absorbed through the skin.

Procedure: Into a large 3-neck flask equipped with an addition funnel, stirrer, and thermometer, add an acid solution prepared by dissolving 214 grams of meta-nitroaniline into 2000 milliliters of 98% sulfuric acid. Thereafter, heat the contents of the flask to 60 Celsius. When the acid solution reaches 60 Celsius, remove the heat source, and then quickly place 570 grams of 99% nitric acid into the addition funnel, and then begin adding this acid, slowly, and drop-wise, to the sulfuric acid/nitroaniline solution over a period sufficient to keep the reaction mixture at 60 Celsius at all times, and while rapidly stirring the reaction mixture. Note: the nitric acid addition will generate enough heat to keep the reaction mixture at the specified temperature, but an ice bath may or may not be added depending on the rate of nitric acid addition. After the addition of the nitric acid, continue to stir the reaction mixture at 60 Celsius for about 40 minutes. Thereafter, place the reaction mixture into an ice bath, if not already done so, and allow the reaction mixture to cool to about 40 Celsius. Afterwards, filter-off the precipitated product, which will be in the form a slurry, using a glass bucher funnel, and thereafter, wash the filtered-off product with 500 milliliters of 50% sulfuric acid, followed by 2000 milliliters of cold water. After washing, vacuum dry or air-dry the product. The result will be about 300 grams of the desired product.

Notes:

Tetraniline explosive composition

Into a beaker, add 52 grams of tetraniline, and then heat to 210 Celsius to melt it. Thereafter, add 30 grams of naphthalene and then 130 grams of TNT, and then rapidly blend the molten mixture for several minutes. After which, rapidly cool the mixture, and then pulverize the resulting solidified solid into a fine powder. Then place this powder into a mixing drum, and then add 322 grams of ammonium nitrate, and 26 grams of charcoal, and then rapidly blend the mixture for several hours to form a uniform mixture. After the blending, press the mixture into any desirable mortar shell, artillery shell, bombshell, or rocket shell under high pressure; preferably under 10,000 psi. This mixture is primarily used in torpedo shells, because of the high degree of pressurized gas produced upon detonation. This pressurized gas, in the form of a pressure wave, fractures the outer shell of a submarine. The amount of tetraniline explosive composition used in an average torpedo shell should be about 3000 pounds. Commercial & Industrial note: Part or parts of this laboratory process may be protected by international, and/or commercial/industrial processes. Before using this process to legally manufacture the mentioned explosive, with intent to sell, consult any protected commercial or industrial processes related to, similar to, or additional to, the process discussed in this procedure. This process may be used to legally prepare the mentioned explosive for laboratory, educational, or research purposes.

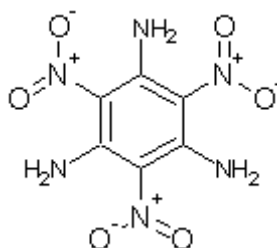
10-02. TATB. 1,3,5-triamino-2,4,6-trinitrobenzene

TATB

TATB is a thermally stable and remarkable explosive with many stable characteristics including shock, percussion, and friction insensitivity. It can be heated to 260 Celsius without any decomposition, but if contaminated with impurities a small sample will decompose rapidly and violently at 260 Celsius. TATB can be melted and alloyed with TNT, RDX, HMX, and solex for making hollow charges, and for filling explosive shells. One interesting characteristic of TATB is that it's used in nuclear weapons to initiate plutonium fission.

Molecular weight: 258.149	Flammability: Burns with smoky flame
Detonating velocity: 7600	Toxicity: Moderate
Sensitivity: Low	Classification: Secondary explosive
Stability: Very good	Overall value (as secondary explosive): Very high

Procedure 10-02A: Preparation of TATB

Materials:	1. 70.8 grams 3,5-dichloroanisole
	2. 100 milliliters 90% nitric acid
	3. 230 milliliters 98% sulfuric acid
	4. 32.6 grams dry ammonia gas
	5. 1700 milliliters of toluene
	6. 200 milliliters of acetone

Summary: TATB is prepared from the intermediate 3,5-dichloro-2,4,6-trinitroanisole. This intermediate is prepared by treating 3,5-dichloroanisole with nitric and sulfuric acids. The resulting 3,5-dichloro-2,4,6-trinitroanisole is then dissolved in

CHAPTER 10: THE PREPERATION OF AMINO NITRO BENZENES

toluene, and the mixture treated with ammonia gas. An autoclave is used in the reaction between the 3,5-dichloro-2,4,6-trinitroanisole and ammonia. An autoclave is a special laboratory machine, which is widely available but expensive. Commercial & Industrial note: For related, or similar information, see Application No. 534,896, June 8, 1990, by The United States of America, to Donald G. Ott, Los Alamos, NM, Theodore M. Benziger, Santa Fe, NM. Part or parts of this laboratory process may be protected by international, and/or commercial/industrial processes. Before using this process to legally manufacture the mentioned explosive, with intent to sell, consult any protected commercial or industrial processes related to, similar to, or additional to, the process discussed in this procedure. This process may be used to legally prepare the mentioned explosive for laboratory, educational, or research purposes.

Hazards: Warning! Wear gloves and use proper ventilation when handling 90% nitric acid and 98% sulfuric acid. 90% nitric acid is highly toxic and corrosive evolving poisonous fumes. Use caution.

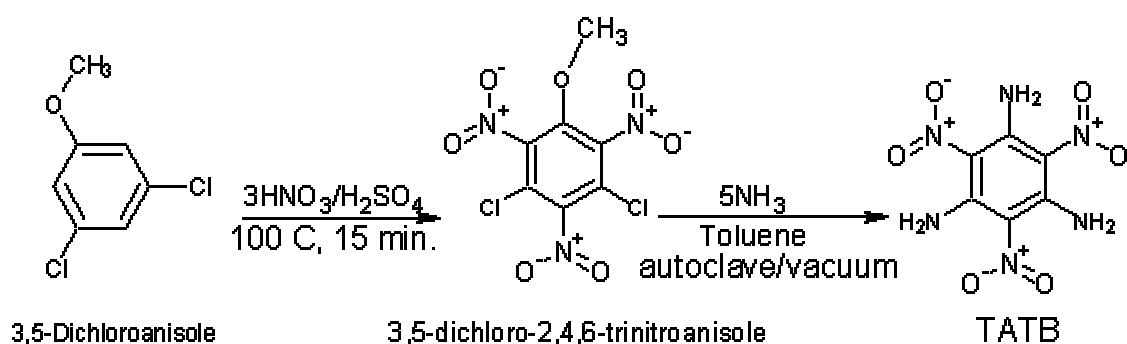

Reaction Equation

Procedure:

Step 1: Preparation of 3,5-dichloro-2,4,6-trinitroanisole

Prepare a acid solution by adding 100 milliliters of 90% nitric acid into 230 milliliters of 98% sulfuric acid, and then cool this acid mixture with an ice bath to 0 Celsius. When the acid mixture reaches 0 Celsius, add 70.8 grams of 3,5-dichloroanisole over a period of 4 minutes while stirring the acid mixture. During the reaction, the temperature of the reaction mixture will rise to 50 Celsius. After addition of the 3,5-dichloroanisole, wait 6 minutes and then remove the ice bath. Afterwards, heat the reaction mixture to 100 Celsius for 46 minutes while stirring. After 46 minutes, cool the reaction mixture to room temperature. After the reaction mixture has reached room temperature, pour the entire mixture onto 1000 grams of ice contained in a beaker. Allow the ice to melt and then filter-off the precipitated product. Then wash with water, and then vacuum dry or air dry. The product should weigh 123 grams with a melting point of 94 Celsius

Step 2: Preparation of TATB

Prepare a solution of the 3,5-dichloro-2,4,6-trinitroanisole by adding 118.4 grams of the 3,5-dichloro-2,4,6-trinitroanisole (prepared in step 1) into 1520 milliliters of toluene. Then place this mixture into a stainless-steel autoclave having a Teflon-covered stirring bar and a system for evacuating to the vapor pressure of toluene (30 - 40 millimeters of mercury). Then bubble 32.6 grams of ammonia gas into the mixture over a period of 1 hour. During the ammonia addition, the temperature will rise to about 30 Celsius. After the addition of the ammonia, open the autoclave and then filter-off the precipitated product. Then wash the bright yellow precipitate with 200 milliliters of toluene, then 1000 milliliters of hot water, and then finally with 200 milliliters of acetone. After washing, vacuum dry or air-dry the product. Then recrystallize the TATB product from either dimethyl sulfoxide (10 grams of TATB for every 2 grams of dimethylsulfoxide at 145 Celsius) or from diphenyl ether (4 grams of TATB for every 2 grams of diphenyl ether at 220 Celsius), and then wash with 200 milliliters of cold water, and then vacuum dry or air-dry. The result will be essentially pure TATB.

Note: 3,5-dichloro-2,4,6-trinitroanisole is also a high explosive, and can be used as such.

Notes:

Procedure 10-02B: Preparation of TATB

Materials:	1. 63 grams 1,3,5-trichloro-2,4,6-trinitrobenzene
	2. 900 milliliters of benzene
	3. 10.2 grams of dry ammonia gas

Summary: TATB is easily prepared by ammoniating trichlorotrinitrobenzene in benzene solvent. The product TATB immediately precipitates upon the addition of the ammonia gas, and continues through out the ammonia addition. After the addition is complete, the product is then filtered-off, washed and dried. Commercial & Industrial note: For related, or similar information, see Serial No. 813,039, May 13th, 1959, by The United States Navy, to Lloyd A. Kaplan, Adelphi, MD, and Francis Taylor, Jr., Baltimore MD. Part or parts of this laboratory process may be protected by international, and/or commercial/industrial processes. Before using this process to legally manufacture the mentioned explosive, with intent to sell, consult any protected commercial or industrial processes related to, similar to, or additional to, the process discussed in this procedure. This process may be used to legally prepare the mentioned explosive for laboratory, educational, or research purposes.

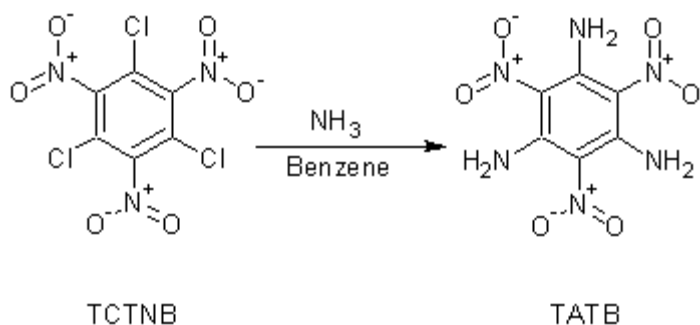
*Reaction Equation*

Hazards: Use proper ventilation when handling ammonia, and avoid inhalation of vapors. Use proper ventilation when handling benzene, and avoid inhalation of vapors. Benzene is known carcinogen.

Procedure: Place 700 milliliters of benzene into a suitable flask, and then add and dissolve 63 grams of 1,3,5-trichloro-2,4,6-trinitrobenzene while stirring. After the trichlorotrinitrobenzene dissolves, pass 10.2 grams of dry ammonia into the solution over a period of 2 hours while rapidly stirring the mixture. Note: A precipitate will form immediately upon the addition of the ammonia gas. After the ammonia addition, reflux the mixture at about 80 Celsius for 1 hour, and then remove the heat source thereafter. Before the mixture cools to room temperature, filter it hot. Upon filtering, bright yellow crystals of TATB are collected on the filter. Allow these crystals to cool to room temperature, and then wash them with 200 milliliters of benzene several times using the same washing portion, and then wash with several hundred milliliters of warm water several times. By this time, the crystals will be halogen free. After washing, vacuum dry or air-dry the crystals. The result will be 52 grams of relatively pure TATB.

Notes:

Procedure 10-02C: Preparation of TATB

Materials:	1. 61.8 grams 1,3,5-trichloro-2,4,6-trinitrobenzene
	2. 600 milliliters of xylene
	3. 10 grams of dry ammonia gas
	4. 200 milliliters hexanes

Summary: TATB is easily prepared by ammoniating trichlorotrinitrobenzene in xylene solvent. The product TATB immediately precipitates upon the addition of the ammonia gas, and continues through out the ammonia addition. After the addition is complete, the product is then filtered-off, washed and dried. Commercial & Industrial note: For related, or similar information, see Serial No. 813,039, May 13th, 1959, by The United States Navy, to Lloyd A. Kaplan, Adelphi, MD, and

CHAPTER 10: THE PREPERATION OF AMINO NITRO BENZENES

Francis Taylor, Jr., Baltimore MD. Part or parts of this laboratory process may be protected by international, and/or commercial/industrial processes. Before using this process to legally manufacture the mentioned explosive, with intent to sell, consult any protected commercial or industrial processes related to, similar to, or additional to, the process discussed in this procedure. This process may be used to legally prepare the mentioned explosive for laboratory, educational, or research purposes.

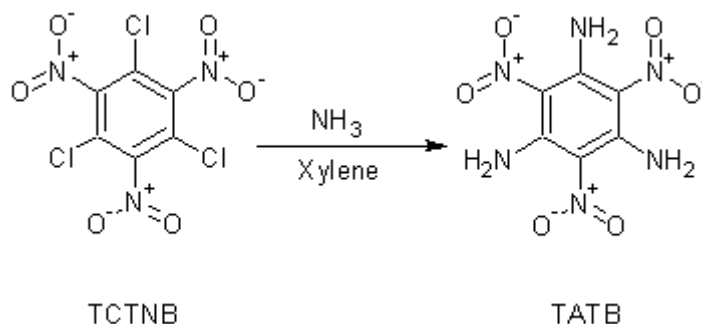

Reaction Equation

Hazards: Use proper ventilation when handling ammonia, and avoid inhalation of vapors.

Procedure: Place 600 milliliters of xylene into a suitable flask, and then add and dissolve 61.8 grams of 1,3,5-trichloro-2,4,6-trinitrobenzene while stirring. After the trichlorotrinitrobenzene dissolves, pass 10 grams of dry ammonia into the solution over a period of 2 hours while rapidly stirring the mixture. Note: A precipitate will form immediately upon the addition of the ammonia gas. After the ammonia addition, filter-off the precipitated product, wash with 200 milliliters of hexanes (several times with the same washing portion), and then with several hundred milliliters of warm water several times. By this time, the crystals will be halogen free. After washing, vacuum dry or air-dry the crystals. The result will be 48 grams of relatively pure TATB.

Notes:

Procedure 10-02D: Preparation of TATB

Materials:	1. 40 grams 1,3,5-trichloro-2,4,6-trinitrobenzene
	2. 900 milliliters of dioxane
	3. 10 grams of dry ammonia gas

Summary: TATB can be made by reacting dry ammonia gas with 1,3,5-trichloro-2,4,6-trinitrobenzene in dioxane solvent. The resulting precipitated product is then filtered-off, washed, and then dried. Commercial & Industrial note: For related, or similar information, see Serial No. 813,039, May 13th, 1959, by The United States Navy, to Lloyd A. Kaplan, Adelphi, MD, and Francis Taylor, Jr., Baltimore MD. Part or parts of this laboratory process may be protected by international, and/or commercial/industrial processes. Before using this process to legally manufacture the mentioned explosive, with intent to sell, consult any protected commercial or industrial processes related to, similar to, or additional to, the process discussed in this procedure. This process may be used to legally prepare the mentioned explosive for laboratory, educational, or research purposes.

CHAPTER 10: THE PREPERATION OF AMINO NITRO BENZENES

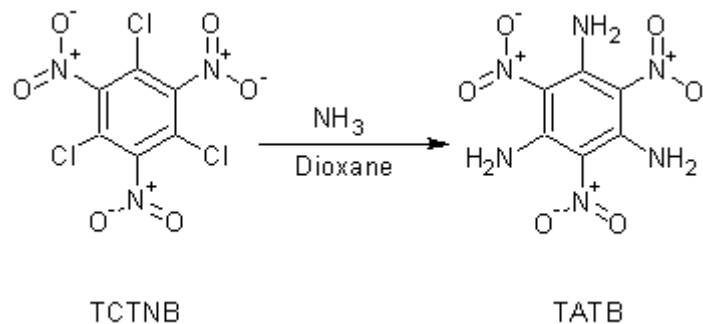

Reaction Equation

Hazards: Use proper ventilation when handling dioxane, and ammonia gas. Avoid inhalation of both vapors. Dioxane is a known carcinogen.

Procedure: Place 300 milliliters of dioxane into a suitable flask, and then bubble 4 grams of ammonia gas into the dioxane at room temperature. Afterwards, add and dissolve 40 grams of 1,3,5-trichloro-2,4,6-trinitrobenzene into 400 milliliters of dioxane. After which, add this trichlorotrinitrobenzene solution to the dioxane/ammonia solution rapidly while stirring the dioxane/ammonia solution rapidly. Thereafter, pass 6 grams of ammonia gas into the reaction mixture over a period of 2 hours while rapidly stirring. During the ammonia addition, the TATB will continuously precipitate. After the addition, reflux the reaction mixture at 100 Celsius for 1 hour. After which, remove the heat source and then filter the reaction mixture hot. After filtering the mixture hot, allow the collected TATB crystals to cool to room temperature, and then wash with 200 milliliters of dioxane, several times with the same washing portion, and then wash with 400 milliliters of warm water. After the washings, vacuum dry or air-dry the product. The result will be 32 grams of relatively pure TATB.

Notes:

RDX/TATB Booster explosive composition

Procedure: Place 18 kilograms of TATB, 10500 grams RDX, and 1500 grams of Teflon 7C (polytetrafluoroethylene) into a large container, and then add 20 liters of hexanes. After the addition of the hexanes, begin rapid blending of the mixture and continue rapid blending for 6 hours. After blending for 6 hours, allow the mixture to settle and then pour-off the hexanes solvent. Then place the explosive solid-mass into an oven and heat at 70 Celsius for 24 hours. After 24 hours, remove the explosive solid from the oven, and allow it to cool to room temperature. To use the explosive solid, break it up into small pieces and use as such, or press it into any desirable mold or container under high pressure. Requires a blasting cap device for initiation. Commercial & Industrial note: For related, or similar information, see Application No. 265,133, May 19, 1981, by The United States Navy, to Irving Kabik, Silver Spring, MD, Vernon D. Ringbloom, West Friendship, MD Part or parts of this laboratory process may be protected by international, and/or commercial/industrial processes. Before using this process to legally manufacture the mentioned explosive, with intent to sell, consult any protected commercial or industrial processes related to, similar to, or additional to, the process discussed in this procedure. This process may be used to legally prepare the mentioned explosive for laboratory, educational, or research purposes.

“TAT” TATB/TNT Castable explosive composition

Into a beaker, place 2 kilogram of TNT, and then heat to 80 Celsius. After the TNT has melted, gradually add in 2 kilograms of TATB over a period of about 60 minutes. During the addition, rapidly stir the molten TNT. After the addition, continue to stir the molten mixture for ten minutes, and then pour the molten mixture into any desirable mold, shape charge mold, bombshell, artillery shell, mortar shell, or missile warhead, and then cure explosive munitions for several days at room temperature. To use, a tetryl booster should be fitted there to, and initiated by a standard blasting cap device. TAT is used to initiate nuclear detonations, and is molded in the form of perfectly geometrical sheets. Commercial & Industrial note: Part or parts of this laboratory process may be protected by international, and/or commercial/industrial processes. Before using this process to legally manufacture the mentioned explosive, with intent to sell, consult any protected commercial or industrial processes related to, similar to, or additional to, the process discussed in this procedure. This process may be used to legally prepare the mentioned explosive for laboratory, educational, or research purposes.

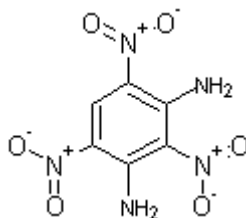
10-03. DATB. *1,3-diamino-2,4,6-trinitrobenzene*

DATB

Uses: Replacement for TATB, main component of thermally stable explosives, additive with initiating compositions to protect against premature firing of blasting caps or detonators as a result of EMF's, and EMP bursts, and component in rocket propellants with HMX or RDX to increase thrust.

Molecular weight: 243.134	Flammability: Burns with smoky flame
Detonating velocity: 7520	Toxicity: Moderate
Sensitivity: Low	Classification: Secondary explosive
Stability: Very good	Overall value (as secondary explosive): High

Procedure 10-03A: Preparation of DATB

Materials:	1. 21.6 grams m-phenylenediamine
	2. 200 milliliters methanol
	3. 21.2 grams sodium carbonate
	4. 43.2 grams ethyl chloroformate
	5. 50 milliliters ethylene glycol dimethyl ether
	6. 200 milliliters 98% sulfuric acid
	7. 300 milliliters 90% nitric acid
	8. 200 milliliters 30% fuming sulfuric acid

Summary: DATB is prepared by reacting m-phenylenediamine with ethyl chloroformate to produce the urethane derivative. The urethane derivative is converted to the nitro derivative by treatment with 30% fuming sulfuric acid and 90% nitric acid. After which, heating with 98% sulfuric acid for three hours, reduces the nitro derivative of the urethane to DATB. Commercial & Industrial note: For related, or similar information, see Application No. 115,337, November 2, 1987, by Texas Explosives Co Inc, to David M. O'Keefe, Mansfield, TX. Part or parts of this laboratory process may be protected by international, and/or commercial/industrial processes. Before using this process to legally manufacture the mentioned explosive, with intent to sell, consult any protected commercial or industrial processes related to, similar to, or additional to, the process discussed in this procedure. This process may be used to legally prepare the mentioned explosive for laboratory, educational, or research purposes.

Hazards: Warning! Wear gloves and use proper ventilation when handling 90% nitric acid, and 30% fuming sulfuric acid. These two acids are highly toxic and corrosive, and they yield choking poisonous fumes. Use great care.

CHAPTER 10: THE PREPERATION OF AMINO NITRO BENZENES

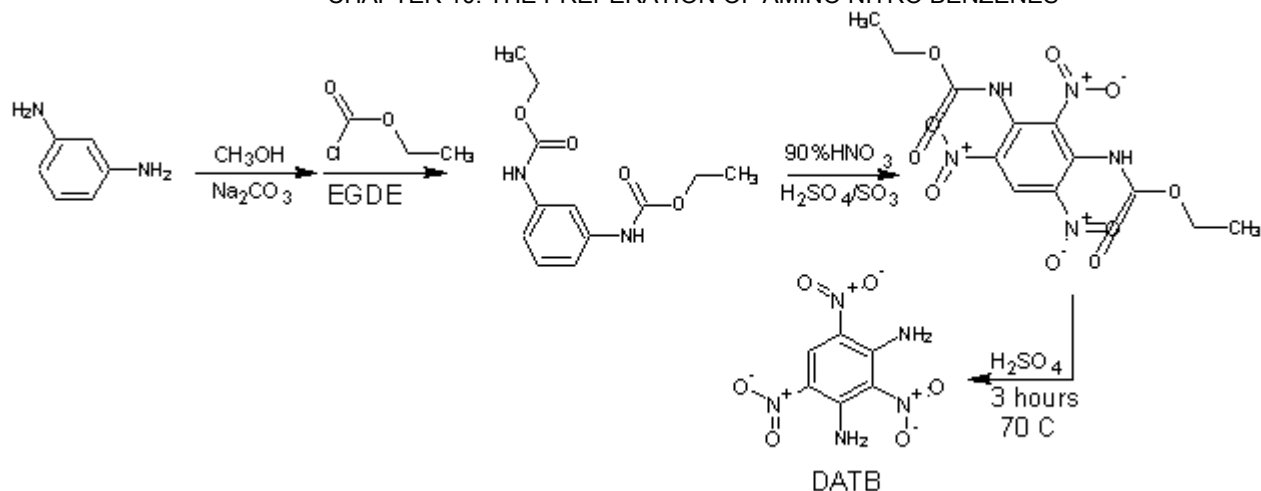
Reaction Equation
Procedure:
Step 1: Preparation of the Bis-urethan of m-Phenylenediamine

Dissolve 21.6 grams of m-phenylenediamine in 200 milliliters of methanol while stirring the methanol, and after the m-phenylenediamine has dissolved, add 21.2 grams of sodium carbonate. After the addition of the sodium carbonate, continue stirring the mixture for 1 hour, and then cool the reaction mixture in an ice water bath. Afterwards, prepare a solution by mixing 43.2 grams of ethyl chloroformate into 50 milliliters of ethylene glycol dimethyl ether. After which, slowly add drop wise, this solution to the reaction mixture over a period of 90 minutes while stirring the reaction mixture. After the addition of the ethyl chloroformate/ethylene glycol dimethyl ether solution, stir the reaction mixture for 1 hour. After 1 hour, pour the resulting pink slurry into 1 liter of ice water, and then filter-off the precipitated urethane compound. Then wash the urethane compound with 1000 milliliters of water, and then vacuum dry or air-dry the product. The result will be 36.6 grams of an almost white powder, which melts at 142 Celsius.

Step 2: Preparation of the bis-urethan of 1,3-Diamino-2,4,6-trinitrobenzene

Cool 100 milliliters of 98% sulfuric acid to 5 Celsius by means of an ice bath, and then dissolve 25.2 grams of the bis-urethan of m-phenylenediamine (prepared in step 1) while stirring the 98% sulfuric acid. The bis-urethan of m-phenylenediamine is slow to dissolve, so rapidly stir until it is completely dissolved. Then prepare a nitration mixture by adding 300 milliliters of 90% nitric acid to 200 milliliters of 30% fuming sulfuric acid, and then cool this nitration mixture to 5 Celsius by means of an ice bath. While keeping the temperature of the nitration mixture at 5 Celsius, slowly add, in small portions, the sulfuric acid/bis-urethan of m-phenylenediamine solution to the nitration acid mixture while stirring the nitrating acid mixture. After the addition of the sulfuric acid/bis-urethan of m-phenylenediamine solution, remove the ice bath and then allow the reaction mixture to slowly warm to room temperature while constantly stirring over a period of 3 hours. After 3 hours, add the reaction mixture to 1 kilogram of crushed ice, which is contained in a beaker, and then wait for the ice to melt. After the ice has melted, filter-off the precipitated product, then wash with 1000 milliliters of cold water, and then vacuum dry or air-dry the product. The product will have a melting point of 193 Celsius.

Note: This procedure uses an excessive amount of 90% nitric acid to properly carryout the reaction. This excessive amount of acid can be recovered by treating the reaction mixture (after complete removal of the product) with methylene chloride to recover the nitric acid. Prior to this action, a small amount of sulfuric acid should be added to the reaction mixture. Afterwards, the reaction mixture should be extracted with several volumes of methylene chloride. These combined volumes can then be carefully distilled to recover the nitric acid of 99% purity (see nitric acid, 90% and 99% respectively).

Step 3: Preparation of DATB from its Bis-urethan

Place 4 grams of the bis-urethan trinitrobenzene (prepared in step 2) into 100 milliliters of 98% sulfuric acid, and then heat the mixture to 70 Celsius for 3 hours while rapidly stirring. During the reaction, bubbles of gas are evolved and the solution slowly turns a deep red color. After 3 hours, remove the heat source and allow the reaction mixture to cool to room temperature. After which, add the cooled reaction mixture to 400 milliliters of ice water, and then filter-off the yellow precipitate. Then wash the

yellow precipitate with 1000 milliliters of cold water, and then vacuum dry or air-dry the product. The product will have a melting point of 279 Celsius.

Notes:

10-04. DATBA. 5-Carboxy-1,3-diamino-2,4,6-trinitrobenzene

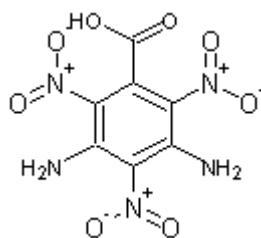

DATBA

Uses: Substitute for TATB, and DATB, in explosives compositions, flares, and high performance gun propellants.

Molecular weight: 287.143	Flammability: Burns with smoky flame
Detonating velocity: Similar to TATB	Toxicity: Moderate
Sensitivity: Low	Classification: Secondary explosive
Stability: Very good	Overall value (as secondary explosive): Moderate

Procedure 10-04A: Preparation of DATBA

Materials:	1. 11 grams 2-amino-2-methylpropane
	2. 7020 milliliters methylene chloride
	3. 20 grams 1,3,5-trifluoro-2,4,6-trinitrobenzene
	4. 30 grams potassium hydrogen carbonate
	5. 100 milliliters trifluoroacetic acid
	6. 9.92 grams cyanotrimethylsilane
	7. 200 milliliters nitromethane
	8. 500 milliliters acetonitrile
	9. 60 milliliters 98% sulfuric acid

Summary: DATBA is prepared from trifluorotrinitrobenzene in a three step process beginning with the preparation of 5-fluoro-1,3-diamino-2,4,6-trinitrobenzene (during this first step, the by-product TATB will be produced, which can be saved). After which, the 5-fluoro-1,3-diamino-2,4,6-trinitrobenzene is then converted into 5-Cyano-1,3-diamino-2,4,6-trinitrobenzene by the reaction with cyanotrimethylsilane and nitromethane. The 5-Cyano-1,3-diamino-2,4,6-trinitrobenzene is then converted into 5-Carboxy-1,3-diamino-2,4,6-trinitrobenzene by the reaction with sulfuric acid. The reaction mixture is then treated with ice, and the desired product of 5-Carboxy-1,3-diamino-2,4,6-trinitrobenzene is filtered-off, washed with water, and then dried. Commercial & Industrial note: For related, or similar information, see Application No. 596,123, April 2, 1984, by The United States Navy, to Michael Chaykovsky, Columbia, MD, Horst G. Adolph, Silver Spring, MD. Part or parts of this laboratory process may be protected by international, and/or commercial/industrial processes. Before using this process to legally manufacture the mentioned explosive, with intent to sell, consult any protected commercial or industrial processes related to, similar to, or additional to, the process discussed in this procedure. This process may be used to legally prepare the mentioned explosive for laboratory, educational, or research purposes.

Hazards: Wear gloves when handling 98% sulfuric acid. 98% Sulfuric acid can cause severe skin burns. Wear gloves when handling trifluoroacetic acid. Acetonitrile is toxic so handle with care.

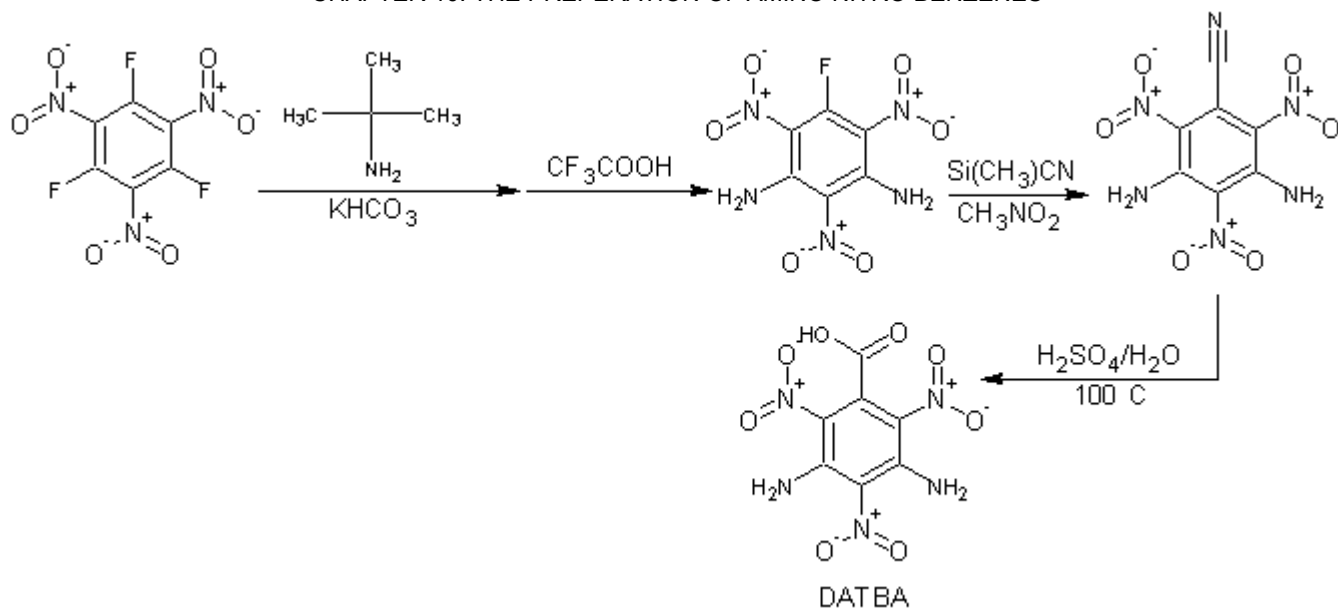

Reaction Equation

Procedure:

Step 1: Preparation of 5-fluoro-1,3-diamino-2,4,6-trinitrobenzene

Dissolve 11 grams of 2-amino-2-methylpropane into 3000 milliliters of methylene chloride. Then prepare a second mixture by adding 20 grams of 1,3,5-trifluoro-2,4,6-trinitrobenzene, and 30 grams of potassium hydrogen carbonate into 800 milliliters of methylene chloride while stirring the methylene chloride. Then cool this mixture to -30 Celsius using a dry ice/acetone bath. Then add drop wise, at a rate of about 10 milliliters per minute, the 2-amino-2-methylpropane/methylene chloride mixture to the 1,3,5-trifluoro-2,4,6-trinitrobenzene mixture while stirring the 1,3,5-trifluoro-2,4,6-trinitrobenzene mixture and maintaining its temperature at -30 Celsius. During the addition, keep the apparatus sealed from air. After addition, remove the dry ice/acetone bath, and allow the reaction mixture to come to room temperature. Then stir the reaction mixture for 15 hours. After 15 hours, filter the reaction mixture (to remove insoluble by-products), and then evaporate-off the methylene chloride by placing the filtered methylene chloride mixture into a distillation apparatus and distilling at 40 Celsius until dry solid remains. When dry solid remains, stop the distillation and allow the dry solids to cool to room temperature. After which, remove the dry solids from the distillation flask to yield 28.4 grams of dry solids. Then add 100 milliliters of trifluoroacetic acid to 200 milliliters of methylene chloride while stirring the methylene chloride. Then add the 28.4 grams of dry solids to this trifluoroacetic acid/methylene chloride mixture and stir the mixture for 20 hours. After 20 hours, filter-off the yellow precipitate. Then place 3200 milliliters of methylene chloride into a 4-liter flask and heat to 60 Celsius. After which, add the filtered-off yellow precipitate to the hot methylene chloride, and stir the mixture for ten minutes. After ten minutes, filter the hot methylene chloride mixture to collect the insoluble 1,3,5-triamino-4,5,6-trinitrobenzene (TATB) by-product (the by-product TATB will weigh 2.3 grams, and can be saved). After filtering-off the by-product TATB, evaporate the methylene chloride by placing the filtered methylene chloride mixture into a distillation apparatus, and distill-off the methylene chloride at 40 Celsius until the remaining liquid in the distillation flask has a total volume of 300 milliliters. When a volume of 300 milliliters is achieved, stop the distillation, and allow the remaining mixture in the distillation flask to cool to room temperature. Then filter this 300 milliliters of remaining liquid to collect the desired product of 5-fluoro-1,3-diamino-2,4,6-trinitrobenzene. Then wash the filtered-off product with 200 milliliters of water, and then vacuum dry or air dry. The result will be 13 grams of 5-fluoro-1,3-diamino-2,4,6-trinitrobenzene with a melting point of 219 Celsius.

Step 2: Preparation of 5-Cyano-1,3-diamino-2,4,6-trinitrobenzene

Prepare a mixture by adding 10.44 grams of 5-fluoro-1,3-diamino-2,4,6-trinitrobenzene (prepared in step 1), and 9.92 grams cyanotrimethylsilane into 200 milliliters of nitromethane. Afterwards, reflux the mixture at 100 Celsius for two hours. After refluxing the mixture for 2 hours, remove the heat source, and allow the mixture to cool to room temperature. Then filter the reaction mixture to remove any insoluble impurities. After which, recrystallize the crude product from the nitromethane, and then vacuum dry or air-dry the product. Then recrystallize the dry product from 200 milliliters of acetonitrile. After recrystallization, vacuum dry or air-dry the product. The yield of 5-cyano-1,3-diamino-2,4,6-trinitrobenzene will be 8.8 grams as orange-brown crystals with a melting point of 212 Celsius (with decomposes).

Step 3: Preparation of 5-Carboxy-1,3-diamino-2,4,6-trinitrobenzene (DATBA)

Prepare a mixture by adding 2.7 grams of 5-cyano-1,3-diamino-2,4,6-trinitrobenzene (prepared in step 2), and 60 milliliters of 98% sulfuric acid into 30 milliliters of water. Then heat the mixture to 100 Celsius for 90 minutes. After 90 minutes, remove the heat source and allow the mixture to cool to room temperature. Afterwards, pour the mixture into 500 milliliters of ice water. Then filter-off the precipitated product, wash with 200 milliliters of water 2 times, and then vacuum dry or air-dry. The yield will be 2.6 grams of crude 5-carboxy-1,3-diamino-2,4,6-trinitrobenzene. Then recrystallize this crude product from 300 milliliters of acetonitrile. After recrystallization, wash the product with 200 milliliters of cold water, and then vacuum dry or air-dry the product. The dry product will be in the form of yellow needles with a melting point of 240 Celsius (with decomposition).

Notes:

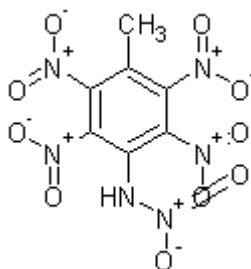
10-05. A-NPNT. 4-amino-N,2,3,5,6-pentanitrotoluene

A-NPNT

Uses: Main component of rocket and gun propellants, ingredient in initiating compositions to replace lead styphnate in blasting caps, fireworks, flares, and explosives compositions when mixed with TNT, RDX, or HMX.

Molecular weight: 316.142	Flammability: Tendency to flash
Detonating velocity: Similar to RDX	Toxicity: Moderate
Sensitivity: Moderate	Classification: Secondary explosive
Stability: Good	Overall value (as secondary explosive): Moderate

Procedure 10-05A: Preparation of A-NPNT

Materials:	1. 100 grams TNT
	2. 200 milliliters dioxane
	3. 46 grams hydrogen sulfide gas
	4. 282 milliliters 28 – 30% ammonia
	5. 1000 milliliters of 10% hydrochloric acid
	6. 12.4 grams potassium iodide
	7. 178 milliliters 98% sulfuric acid
	8. 15 grams paraformaldehyde
	9. 1300 milliliters methylene chloride
	10. 10 milliliters 90% nitric acid
	11. 300 milliliters of methanol
	12. 200 grams of anhydrous magnesium sulfate
	13. 1000 milliliters of chloroform

Summary: A-NPNT is prepared in a three step process starting with the well know high explosive, TNT. TNT is reduced to 4-amino-2,6-dinitrotoluene with hydrogen sulfide gas and ammonia solution. The reduction product is then converted to 4-

CHAPTER 10: THE PREPERATION OF AMINO NITRO BENZENES

amino-N-methyl-2,6-dinitrotoluene by treatment with sulfuric acid and paraformaldehyde. The resulting product is then converted to 4-amino-N,2,3,5,6-pentanitrotoluene by treatment with 98% sulfuric acid and 90% nitric acid. Commercial & Industrial note: For related, or similar information, see Application No. 456,672, January 10, 1983, by The United States Navy, to Ronald L. Atkins, Ridgecrest, CA, Richard A. Hollins, Ridgecrest, CA, William P. Norris, Ridgecrest, CA, Arnold T. Nielsen, Ridgecrest, CA, William S. Wilson, Greensborough, AU. Part or parts of this laboratory process may be protected by international, and/or commercial/industrial processes. Before using this process to legally manufacture the mentioned explosive, with intent to sell, consult any protected commercial or industrial processes related to, similar to, or additional to, the process discussed in this procedure. This process may be used to legally prepare the mentioned explosive for laboratory, educational, or research purposes.

Hazards: Wear gloves and use proper ventilation when handling 90% nitric acid. 90% nitric acid is a highly toxic and corrosive liquid, which evolves highly poisonous fumes of nitrogen oxides. Use great care. Wear gloves when handling 96% sulfuric, which can cause skin burns. Use proper ventilation when handling hydrogen sulfide gas. Hydrogen sulfide is a highly poisons gas, so exercise great care. Use proper ventilation when handling 28 – 30% ammonia solution.

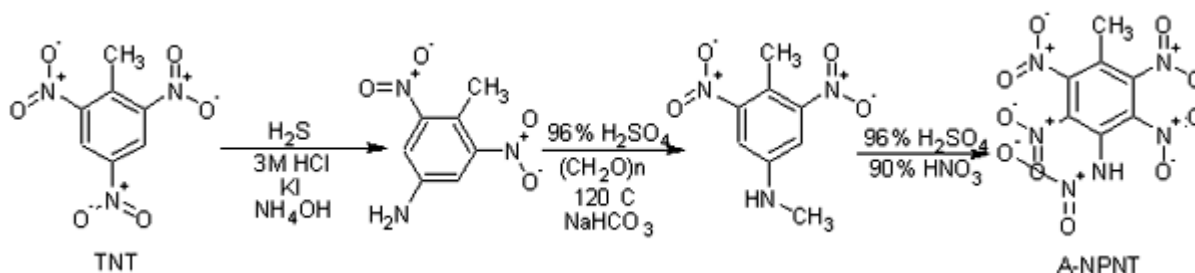

Procedure:

Step 1: Preparation of 4-amino-2,6-dinitrotoluene

Dissolve 100 grams of 2,4,6-trinitrotoluene into 200 milliliters of p-dioxane, and then place the mixture into a cold-water bath. Then stir the mixture, and add 2 milliliters of 28 – 30% ammonium solution. Then bubble 46 grams of hydrogen sulfide gas into the mixture over a 2-hour period while keeping the reaction temperature at 20 Celsius by means of the cold-water bath, and stir the reaction mixture continuously during the addition. After the addition of the hydrogen sulfide gas, filter off the precipitated sulfur, and then add the filtered reaction mixture to 1000 milliliters of ice water. After which, filter off the yellow precipitated solid, and then wash the solid with 400 milliliters of water. Then vacuum dry or air-dry the solid. The result is a mixture of the desired 4-amino-2,6-dinitrotoluene (61%), and the by-product, 4-hydroxylamino-2,6-dinitrotoluene (39%).

Add 20 grams of the dry solid mixture (obtained above) into 1000 milliliters of 10% hydrochloric acid while stirring the hydrochloric acid. Then add 6.2 grams of potassium iodide while stirring the 10% hydrochloric acid, and then reflux the mixture at 100 Celsius for 20 minutes. After 20 minutes, continue heating for an additional hour. After which, add another 6.2 grams of potassium iodide while stirring the mixture, and continue refluxing for 1 hour. After 1 hour, filter the mixture hot. Then allow the mixture to cool to room temperature, and then add 280 milliliters of 28 – 30% ammonia solution. After the addition of the 28 – 30% ammonia solution, filter-off the yellow precipitated product, wash with 400 milliliters of water, and then vacuum dry or air-dry. Then recrystallize the product from 300 milliliters of methanol, and then wash with 200 milliliters of water. Then vacuum dry or air-dry the product. The yield will be 8 grams of the desired 4-amino-2,6-dinitrotoluene, as yellow crystals with a melting point of 168 Celsius.

Step 2: Preparation of 4-amino-N-methyl-2,6-dinitrotoluene

Dissolve 8 grams of 4-amino-2,6-dinitrotoluene (prepared in step 1) into 50 milliliters of 98% sulfuric acid, and then heat the mixture to 120 Celsius while stirring. Then add 15 grams of paraformaldehyde in small portions, over a 2-hour period while stirring the 98% sulfuric acid mixture. Keep the mixture at 120 Celsius. After addition of the paraformaldehyde, heat the mixture at 120 Celsius for an additional hour while stirring. After which, remove the heat source, and allow the mixture to cool to room temperature. Then pour the mixture onto 400 grams of ice, which is contained in a beaker. After the ice has melted, add 500 milliliters of methylene chloride, and stir the mixture rapidly for ten minutes. Then remove the upper methylene chloride layer either by decanting it, or using a separatory funnel (drain-off the bottom acid layer first). Thereafter, add 100 grams of anhydrous magnesium sulfate (to absorb water) to the methylene chloride layer, and allow the mixture to stand for ten minutes. After ten minutes, filter-off the magnesium sulfate. Then evaporate-off the methylene chloride by placing the

CHAPTER 10: THE PREPERATION OF AMINO NITRO BENZENES

methylene chloride layer into a distillation apparatus, and distill the methylene chloride at 40 Celsius until dry solid remains. If using a rotary evaporator, evaporate-off the solvent under low vacuum. Afterwards, recrystallize the dry solid from 500 milliliters of chloroform. Afterwards, wash the product with 400 milliliters of water, and then vacuum dry or air-dry the product. The yield will be 3.4 grams of 4-amino-N-methyl-2,6-dinitrotoluene, as orange crystals with a melting point of 137 Celsius.

Step 3: Preparation of 4-amino-N,2,3,5,6-pentanitrotoluene

Dissolve 3 grams of 4-amino-N-methyl-2,6-dinitrotoluene (prepared in step 2) into 128 milliliters of 98% sulfuric acid while stirring the 98% sulfuric acid, and then cool the mixture in an ice bath. When the temperature of the mixture reaches about 0 Celsius, slowly add 9.6 milliliters of 90% nitric acid drop wise, over a 30 minute period while stirring the 98% sulfuric acid mixture, and keeping the mixture at 0 Celsius. After the addition of the 90% nitric acid, remove the ice bath, and allow the reaction mixture to warm to room temperature. After which, stir the reaction mixture at room temperature for 3.5 hours. After 3.5 hours, extract the reaction mixture with eight 80-milliliter portions of methylene chloride. During the extraction, the methylene chloride will be the upper layer each time. After extracting the reaction mixture 8 times, combine all portions of methylene chloride (if not already done so), and then add 100 grams of anhydrous magnesium sulfate (to absorb water). Allow the methylene chloride mixture to stand for ten minutes. After which, filter-off the magnesium sulfate, and then place the methylene chloride mixture into a distillation apparatus. Then distill-off the methylene chloride at 40 Celsius until dry solid remains (a rotary evaporator is preferred). When dry solid remains in the distillation flask, remove the heat source, and allow the dry solid to cool to room temperature. Afterwards, collect the dry solid, and then recrystallize from 500 milliliters of chloroform. Then wash the product with 200 milliliters of water, and then vacuum dry or air-dry the product. The yield will be 800 milligrams of 4-amino-N,2,3,5,6-pentanitrotoluene, as pale yellow crystals with a melting point of 140 Celsius.

Notes:

10-06. UDTNB. 5-ureido-1,3-diamino-2,4,6-trinitrobenzene

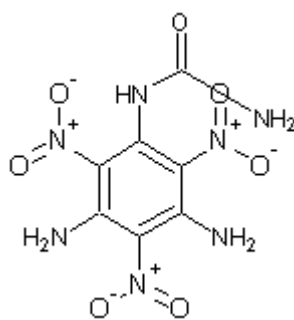

UDTNB

Uses: Substitute for A-NPNT, or as a stabilizer towards A-NPNT, in making military dynamites, substitute for TATB, and DATB, and in making explosives compositions.

Molecular weight: 301.173	Flammability: Burns with smoky flame
Detonating velocity: Similar to TATB	Toxicity: Moderate
Sensitivity: Low	Classification: Secondary explosive
Stability: Very good	Overall value (as secondary explosive): Moderate

Procedure 10-06A: Preparation of UDTNB

Materials:	1. 2400 milliliters of 30% fuming sulfuric acid
	2. 560 grams potassium nitrate
	3. 112 grams 1,3,5-trifluorobenzene
	4. 8620 milliliters methylene chloride
	5. 300 milliliters hexanes

CHAPTER 10: THE PREPERATION OF AMINO NITRO BENZENES

6.	40 grams charcoal
7.	40 grams anhydrous sodium sulfate
8.	11 grams 2-amino-2-methylpropane
9.	30 grams potassium hydrogen carbonate
10.	3200 milliliters 1,2-dichloroethane
11.	100 milliliters trifluoroacetic acid
12.	60 milliliters dimethylformamide (DMF)
13.	3.6 grams urea

Summary: UDTNB, 5-ureido-1,3-diamino-2,4,6-trinitrobenzene, is prepared in a three step process starting with trifluorobenzene. Trifluorobenzene is converted into 1,3,5-trifluoro-2,4,6-trinitrobenzene by treatment with potassium nitrate and fuming sulfuric acid. 1,3,5-trifluoro-2,4,6-trinitrobenzene is converted into 5-fluoro-1,3-diamino-2,4,6-trinitrobenzene by treatment with 2-amino-2-methyl propane, potassium hydrogen carbonate, and trifluoroacetic acid. Finally, 5-fluoro-1,3-diamino-2,4,6-trinitrobenzene is treated with urea and dimethylformamide to yield the high explosive, 5-ureido-1,3-diamino-2,4,6-trinitrobenzene. The high explosive TATB is a by-product, and can be saved. Commercial & Industrial Note: For related, or similar information, see Application No. 595,806, April 2, 1984, by The United States Navy, to Michael Chaykovsky, Columbia, MD, Horst G. Adolph, Silver Spring, MD. Part or parts of this laboratory process may be protected by international, and/or commercial/industrial processes. Before using this process to legally manufacture the mentioned explosive, with intent to sell, consult any protected commercial or industrial processes related to, similar to, or additional to, the process discussed in this procedure. This process may be used to legally prepare the mentioned explosive for laboratory, educational, or research purposes.

Hazards: Wear gloves and use proper ventilation when handling 30% fuming sulfuric acid, which is a highly corrosive and toxic liquid evolving poisonous choking fumes of sulfur trioxide. Wear gloves when handling corrosive trifluoroacetic acid, which can cause sever skin burns. Use proper ventilation when handling hexane, which is highly flammable and volatile.

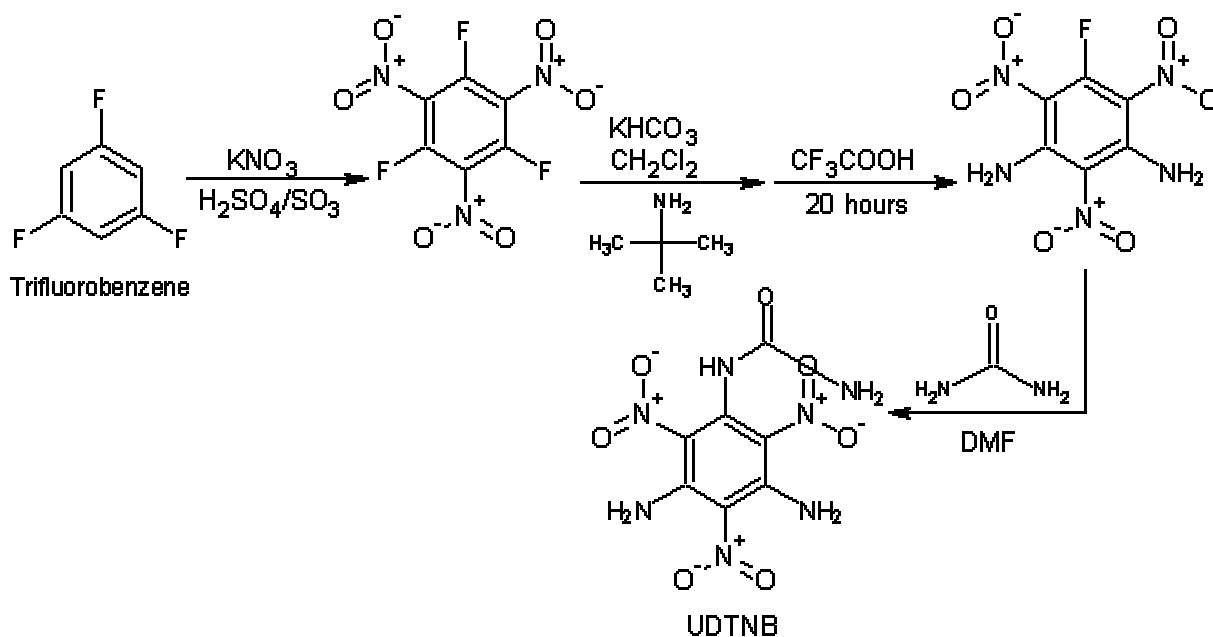

Reaction Equation

Procedure:

Step 1: Preparation of 1,3,5-trifluoro-2,4,6-trinitrobenzene

Place 2400 milliliters of 30% fuming sulfuric acid into a 6-liter 3-neck flask equipped with a stirrer and thermometer, and then cool the acid to 0 Celsius by means of an ice bath. Then, while maintaining the acid at 0 Celsius and stirring, slowly add 560 grams of potassium nitrate in small portions over a 2-hour period. After the addition of the potassium nitrate, remove the ice bath, and then place the reaction mixture into a hot water bath at 50 Celsius. Then slowly add 112 grams of 1,3,5-trifluorobenzene over a period of 2 hours while maintaining the temperature of the reaction mixture at 50 Celsius and stirring.

CHAPTER 10: THE PREPERATION OF AMINO NITRO BENZENES

After the addition, place the reaction mixture into a reflux apparatus, and reflux at 153 Celsius for 3 days. After 3 days, remove the heat source, and allow the reaction mixture to cool to room temperature. Then extract the reaction mixture with six 1200-milliliter portions of methylene chloride. The methylene chloride will be the upper layer. After the extraction is complete, combine all six portions of methylene chloride (if not already done so), and then place the combined portions into a distillation apparatus. Now, distill the methylene chloride at 40 Celsius until the total volume of the methylene chloride reaches 500 milliliters. After which, stop the distillation, and allow the methylene chloride mixture to cool to room temperature. Then add 40 grams of anhydrous sodium sulfate (to absorb water), and then stir the mixture for ten minutes. Afterwards, filter-off the sodium sulfate, and then add 300 milliliters of hexane to the filtered methylene chloride mixture while stirring the methylene chloride mixture. After the addition of the hexane, add 40 grams of charcoal, and then stir the mixture vigorously for ten minutes. After ten minutes, filter-off the charcoal, and then distill the methylene chloride/hexane mixture at 40 Celsius until no more liquid collects in the receiver flask (this means all the methylene chloride has distilled over). When this point is reached, remove the heat source, and allow the mixture to cool to room temperature. Afterwards, add 300 milliliters of more hexane, and then distill the mixture at 70 Celsius until dry solid remains (the distillation may need to be temporarily stopped in order to filter-off precipitated product). If using a rotary evaporator, evaporator-off the solvent under vacuum. When dry solid remains, remove the heat source, and allow the contents in the distillation flask to cool to room temperature. Then collect the dry product from the distillation flask, and then vacuum dry or air-dry any product that may have been filtered-off during the distillation process. Then combine all the dry product, and then wash with 400 milliliters of water. Thereafter, vacuum dry or air-dry the product. The result will be 121 grams of 1,3,5-trifluoro-2,4,6-trinitrobenzene with a melting point of 80 Celsius.

Step 2: Preparation of 5-fluoro-1,3-diamino-2,4,6-trinitrobenzene

Prepare a solution (solution A) by adding 11 grams of 2-amino-2-methylpropane to 3000 milliliters of methylene chloride. Prepare a second solution (solution B) by adding 20 grams of 3,5-trifluoro-2,4,6-trinitrobenzene (prepared in step 1), and 30 grams of potassium hydrogen carbonate into 800 milliliters of methylene chloride. Then cool this solution to -30 Celsius using a dry ice/acetone bath. Then, while stirring solution B and maintaining its temperature at -30 Celsius, add solution A at a rate of 5 milliliters a second. During the addition of solution A, keep the apparatus sealed from the air. After the addition of solution A, remove the dry ice/acetone bath, and then stir the reaction mixture for 15 hours at room temperature (keep the apparatus sealed from air). Afterwards, filter the reaction mixture (save the filtered-off solids and then vacuum dry or air-dry them), and then place the reaction mixture into a distillation apparatus and distill at 40 Celsius until dry solid remains (the distillation may need to be temporarily stopped in order to filter-off precipitated product). When dry solid remains, remove the heat source, and allow the contents in the distillation flask to cool to room temperature. Then collect the dry product from the distillation flask, and then vacuum dry or air-dry any product that may have been filtered-off during the distillation process. Then combine all the dry product, including the filtered-off solids obtained before the distillation process. Then prepare a solution by adding 100 milliliters of trifluoroacetic acid to 20 milliliters of methylene chloride, and then add the filtered-off dry product while stirring the trifluoroacetic acid/methylene chloride mixture. After adding the dry product, stir the mixture at room temperature for 20 hours. After which, filter off the yellow precipitate, and then vacuum dry or air-dry it. Then heat 3200 milliliters of 1,2-dichloroethane (methylene chloride can be used as a substitute) to 40 Celsius, and then add the dry yellow precipitate. Dissolve the yellow precipitate while stirring the hot mixture. Then stir the hot mixture for ten minutes, and then filter the mixture hot. Filtration of this mixture will give about 2 grams of the insoluble 1,3,5-triamino-4,5,6-trinitrobenzene by-product (this by-product can be saved). After filtering, place the hot liquid into a distillation apparatus and distill at 55 Celsius (if using methylene chloride distill at 40 Celsius) until the total volume of the liquid reaches 300 milliliters. When the volume reaches 300 milliliters, stop the distillation and allow the mixture to cool to room temperature. Then filter-off the precipitated product, wash with 400 milliliters of water, and then vacuum dry or air-dry the product. The yield will be 14 grams with a melting point of 219 Celsius.

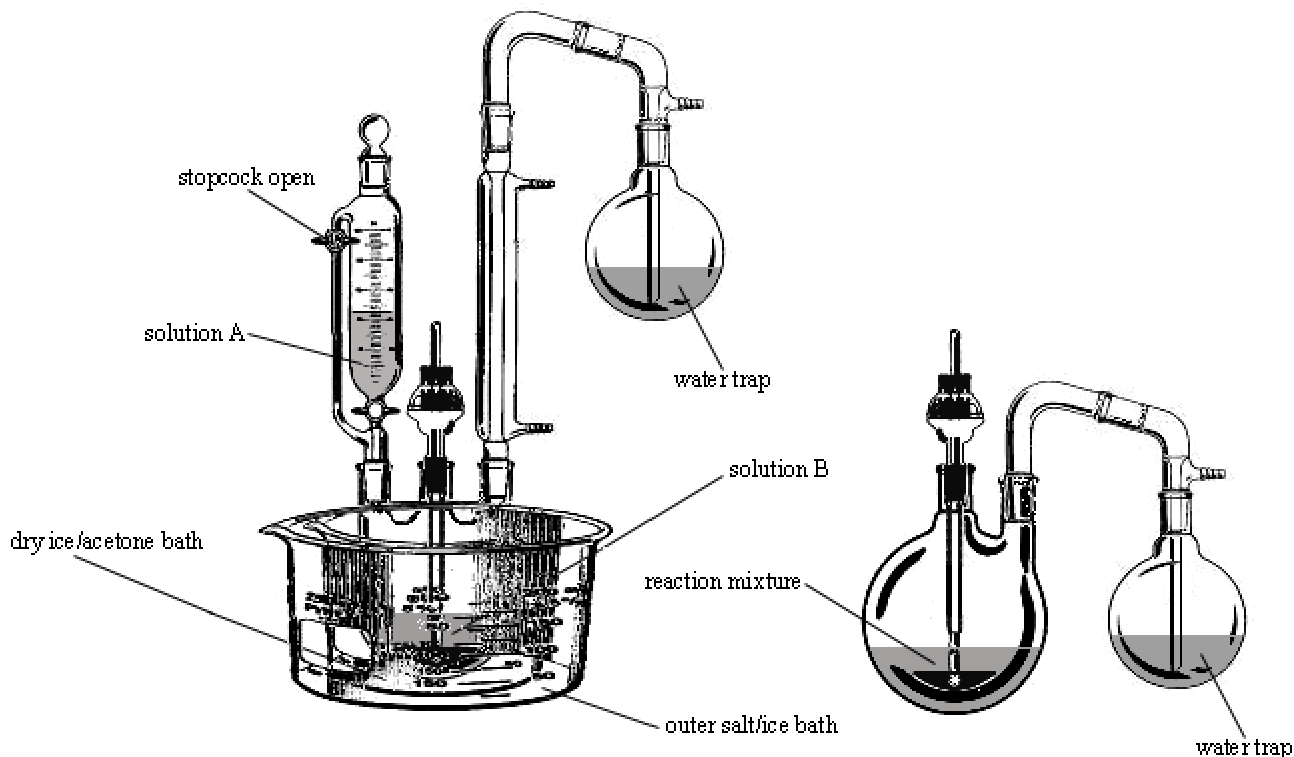

Figure 054. Apparatus for step 2. Left illustration: Set-up for keeping air out during the chemical reaction. Right illustration: set-up for keeping air out during the stirring period.

Step 3: Preparation of 5-ureido-1,3-diamino-2,4,6-trinitrobenzene

Prepare a solution by adding 3 grams of 5-fluoro-1,3-diamino-2,4,6-trinitrobenzene (prepared in step 2), and 3.6 grams of urea into 60 milliliters of dimethylformamide (DMF). Then heat this mixture at 90 Celsius for 1 hour while stirring the mixture (a yellow precipitate will form after about 5 minutes). After 1 hour, remove the heat source and allow the mixture to cool to room temperature. Thereafter, pour the entire reaction mixture into 300 milliliters of cold water, and then filter-off the precipitated product. Then mix the filtered-off precipitate with 200 milliliters dimethylformamide, and stir for 20 minutes. Finally, filter-off the product, wash with 200 milliliters of water, and then vacuum dry or air-dry the product. The result will be 3 grams of 5-ureido-1,3-diamino-2,4,6-trinitrobenzene with a melting point of 350 Celsius (with decomposition).

Notes:

10-07. DNPU. 2,4-dinitrophenylurea

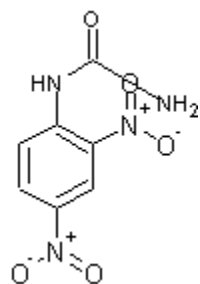

DNPU

Uses: Shows limited use in military dynamites when mixed with nitroglycerine, fireworks, flares, and explosives compositions when mixed with TATB, or DATB.

Molecular weight: 226.146	Flammability: Burns with smoky flame
Detonating velocity: Uncalculated	Toxicity: Moderate
Sensitivity: Low	Classification: Secondary explosive
Stability: Very good	Overall value (as secondary explosive): Low

Procedure 10-07A: Preparation of DNPU

Materials:	1. 91.2 grams phenylurea
	2. 300 milliliters methylene chloride
	3. 364 milliliters 98% sulfuric acid
	4. 63 milliliters 90% nitric acid
	5. 200 milliliters 5% sodium bicarbonate solution (<i>prepare by dissolving 10 grams of sodium bicarbonate into 190 milliliters of water</i>)

Summary: 2,4-dinitrophenylurea is prepared by treating phenylurea with 98% sulfuric acid, and then adding 90% nitric acid. The product is then obtained by evaporating the solvent, and then condensing the product by treating the reaction mixture with ice water. The product is then collected by filtration, washed, and then dried. Commercial & Industrial note: Part or parts of this laboratory process may be protected by international, and/or commercial/industrial processes. Before using this process to legally manufacture the mentioned explosive, with intent to sell, consult any protected commercial or industrial processes related to, similar to, or additional to, the process discussed in this procedure. This process may be used to legally prepare the mentioned explosive for laboratory, educational, or research purposes.

Hazards: Wear gloves and use proper ventilation when handling 90% nitric acid, which is a highly corrosive and poisonous liquid evolving poisonous fumes of nitrogen oxides. Wear gloves when handling 98% sulfuric acid, which is highly corrosive.

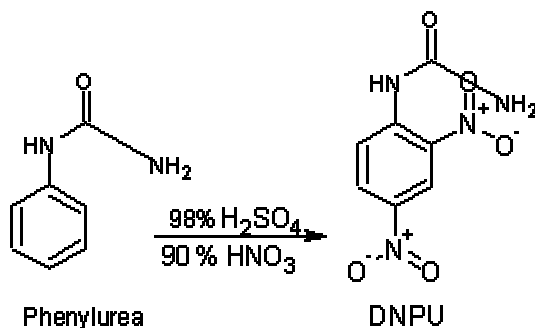

Reaction Equation

Procedure: Add 91.2 grams of phenylurea into 300 milliliters of methylene chloride, and then place the mixture into a flask equipped with a stirring bar, addition funnel, and reflux condenser. Then cool the mixture to -10 Celsius by means of an ice/salt bath, and stir the mixture rapidly. Then add 364 milliliters of 98% sulfuric acid over a period of 40 minutes while stirring the methylene chloride mixture, and keep its temperature at -10 Celsius. After the addition of the 98% sulfuric acid, slowly add 63 milliliters of 90% nitric acid over a 50-minute period while stirring the reaction mixture, and maintain its temperature at -10 Celsius. After the addition of the 90% nitric acid, remove the ice/salt bath, and allow the reaction mixture to warm to room temperature. Then, maintain this temperature for 1 hour while stirring. Afterwards, place the reaction mixture into a distillation apparatus, and then distil-off the methylene chloride at 40 Celsius until no more methylene chloride is collected in the receiver flask (the distillation may need to be temporarily stopped in order to filter-off precipitated product). When all the methylene chloride has been distilled-off, remove the heat source, and allow the remaining mixture in the distillation flask to cool to room temperature. Then vacuum dry or air-dry any product that may have been filtered-off during the distillation process. Then remove the mixture from the distillation flask, and add it to 1000 milliliters of cold water (make sure the temperature of the water does not rise above 10 Celsius. Sulfuric acid generates a lot of heat when dissolved in water). Thereafter, add any product that may have been filtered-off during the distillation process to the 1000 milliliters of cold water. Then stir the cold water for 20 minutes. After which, filter-off the precipitated product, wash with 500 milliliters of cold water, 200 milliliters of 5% sodium bicarbonate solution, and then with two 500 milliliter portions of water. Then vacuum dry or air-dry the product. The product will weigh 140 grams.

Notes:

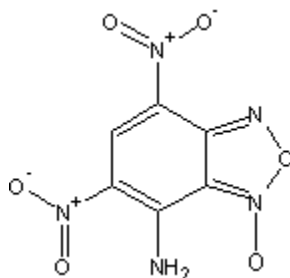
10-08. ADNBF. *7-amino-4,6-dinitrobenzofuroxan*

ADNBF

ADNBF forms white to yellowish crystals, which decompose when heated to 270 Celsius. It may be used in explosives compositions, but its primary use is in solid rocket propellants, where it exhibits exceptional combustion properties equal to, or superior to ammonium perchlorate. ADNBF can be alloyed with TNT, RDX, or other high-energy secondary explosives for use in military or commercial blasting compositions. ADNBF also shows interests in pyrotechnic compositions, and in primary explosive compositions for use in blasting caps.

Molecular weight: 241.119	Flammability: May deflagrate on ignition
Detonating velocity: Uncalculated (6500 estimated)	Toxicity: High
Sensitivity: Moderate	Classification: Secondary explosive
Stability: Good	Overall value (as secondary explosive): Moderate

Procedure 10-08A: Preparation of ADNBF

Materials:	1. 300 grams of tetraniline
	2. 1400 milliliters of glacial acetic acid
	3. 153 grams of sodium azide

Summary: ADNBF can be easily made by treating an acetic acid suspension of tetraniline with sodium azide, followed by heating the resulting mixture. The reaction mixture is then allowed to stand overnight, and the following day, the precipitated product is filtered-off, washed, and then dried. Commercial & Industrial note: For related, or similar information, see Application No. 701,582, May 14, 1991, by Rockwell International Corporation, to James F. Weber, Moorpark, CA. Part or parts of this laboratory process may be protected by international, and/or commercial/industrial processes. Before using this process to legally manufacture the mentioned explosive, with intent to sell, consult any protected commercial or industrial processes related to, similar to, or additional to, the process discussed in this procedure. This process may be used to legally prepare the mentioned explosive for laboratory, educational, or research purposes.

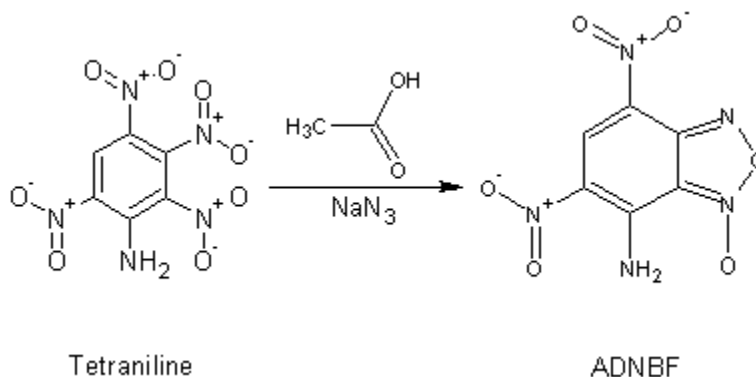
*Reaction Equation*

Hazards: Wear gloves when handling glacial acetic acid, which can cause mild skin burns and irritation. Glacial acetic acid is flammable, so extinguish all flames before using.

Procedure: Into a large 3-neck flask equipped with an addition funnel, thermometer, and stirrer, place 1400 milliliters of glacial acetic acid, followed by 300 grams of Tetraniine. Thereafter, prepare a sodium azide solution by dissolving 153 grams of sodium azide into 400 milliliters of water, and then place this sodium azide solution into the addition funnel, and then add drop-wise, this solution to the reaction mixture over a period sufficient enough to keep the reaction mixtures temperature around room temperature, while continuously stirring the reaction mixture. A cold-water bath may or may not be needed. After the addition, remove the cold-water bath, if one is used, and then gradually heat the reaction mixture to 80 Celsius, while stirring the reaction mixture. Continue to heat the reaction mixture for about 60 minutes. Note: During the heating process, a vigorous gas evolution will take place. Monitor this gas evolution, and ensure it does not become too violent; if it does, temporarily reduce the heat. After heating for 60 minutes, remove the heat source, and allow the reaction to cool to room temperature, and then allow it to stand over night. The next day, filter-off the precipitated product, wash with 1000 milliliters of water, and then vacuum dry or air-dry. The result will be about 250 grams of dry product. Note: For long time storage, store the product moistened with a water free inert solvent.

10-09. TNPU. *N,N'*-bis(2,4,6-trinitrophenyl)urea

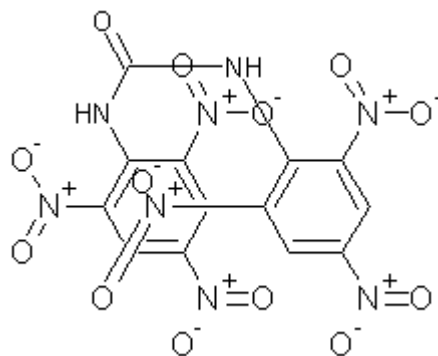

TNPU

TNPU is a military explosive commonly used in explosives compositions admixed with TNT, picric acid, or other low melting secondary explosives. It forms whitish to light pale to light yellowish crystals with a melting point of 207 Celsius (with decomposition starting). The crystals are insoluble in water, but somewhat soluble in acetic acid, alcohol, and chloroform, and soluble in acetone. TNPU has excellent thermal stability making it suitable for use in a variety of applications including missile warheads, artillery shells, and demolition charges.

Molecular weight: 482.233	Flammability: Burns with no violence
Detonating velocity: 7050	Toxicity: Mild
Sensitivity: Low	Classification: Secondary explosive
Stability: Good	Overall value (as secondary explosive): Moderate

Procedure 10-09A: Preparation of TNPU

Materials:	1. 156 milliliters of 98% sulfuric acid
	2. 82 grams of N,N'-diphenylurea
	3. 290 milliliters of 99% nitric acid
	4. 250 milliliters of a 5% sodium bicarbonate solution

Summary: TNPU is prepared in a two step process starting with the formation of a mixture of tetranitro and trinitro isomers of N,N'-diphenylurea. These isomers are prepared by reacting 99% nitric acid with N,N'-diphenylurea in the presence of concentrated sulfuric acid. The resulting reaction mixture is treated with ice water to precipitate the nitro isomers, which are then collected by filtration, washed, and then dried. The second step is merely an extra nitration process carried out at a higher temperature. The dry nitro isomers are treated with 99% nitric acid and concentrated sulfuric acid at 90 Celsius, and then the resulting TNPU is then separated by treating the reaction mixture with ice water. The precipitated crystals are then collected by filtration, washed, and then dried.

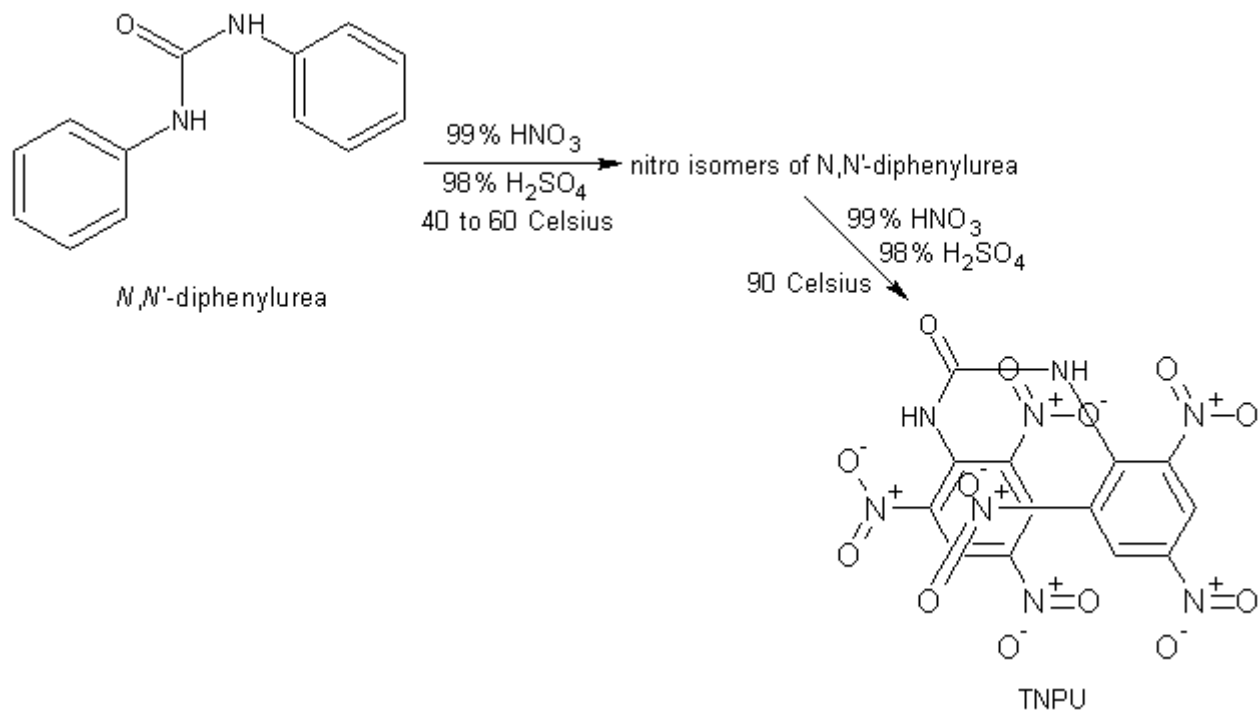

Hazards: Use maximum ventilation when handling 99% nitric acid, which is highly corrosive and evolves dangerous and toxic fumes of nitrogen oxides. Use great care. Handle concentrated sulfuric acid with care, as it is highly corrosive.

Procedure:

Step 1: Preparation of tetranitro and trinitro isomers of N,N'-diphenylurea

Into a suitable flask, add 135 milliliters of 98% sulfuric acid, followed by 82 grams of N,N'-diphenylurea. Thereafter, stir the mixture to dissolve most of the N,N'-diphenylurea. Afterwards, place 250 milliliters of 99% nitric acid into a clean reflux apparatus fitted with a motorized stirrer, and then gently reflux the nitric acid at 40 Celsius using a hot plate or oil bath. When the temperature of the nitric acid reaches 40 Celsius, slowly add drop-wise, the N,N'-diphenylurea/sulfuric acid mixture to the 99% nitric acid while rapidly stirring the nitric acid and maintaining its temperature around 40 Celsius. After the addition of the N,N'-diphenylurea/sulfuric acid mixture, reflux the entire reaction mixture at 65 Celsius for 2 hours with constant stirring. After 2 hours, remove the heat source, and allow the reaction mixture to cool to room temperature. Thereafter, drown the entire reaction mixture into 500 milliliters of ice water, and allow this entire mixture to stand at room temperature for 24 hours. Thereafter, filter-off the precipitated solid (composed of tetranitro, and trinitro isomers of N,N'-diphenylurea), and then vacuum dry or air dry this solid.

Step 2: Preparation of TNPU

CHAPTER 10: THE PREPERATION OF AMINO NITRO BENZENES

Into a clean reflux apparatus (equipped with motorized stirrer, and powder addition funnel), add 40 milliliters of 99% nitric acid, followed by carefully adding 21 milliliters of 98% sulfuric acid. Then heat this acid mixture to 90 Celsius while stirring. When the temperature of this acid mixture reaches 90 Celsius, slowly add in 22 grams of the dry solid obtained in step 1 in small pieces at a time, over a period of about 90 minutes, while constantly stirring the nitric acid/sulfuric acid solution and maintaining its temperature at 90 Celsius. After the addition of the solid product obtained in step 1, reduce the heat to 60 Celsius, and continue to reflux the entire reaction mixture for 1 hour with constant stirring. Afterwards, remove the heat source, and allow the reaction mixture to cool to room temperature. Then pour the entire reaction mixture into 500 milliliters of ice water, and then allow the entire mixture to stand for 12 hours. Thereafter, filter-off the precipitated solid product, wash with 500 milliliters of cold water, followed by 250 milliliters of a 5% sodium bicarbonate solution, and then 250 milliliters of cold water. Then vacuum dry or air-dry the solid product.

Notes:

CHAPTER 11: THE PREPARATION OF NITRO BENZENES

TNT, F-TNB, TCTNB, PICRYL CHLORIDE, TNBCI

11-01. TNT. 2,4,6-trinitrotoluene; trinitrotoluene

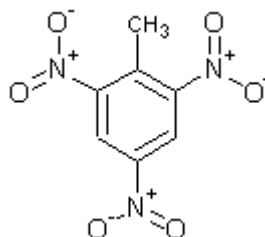

TNT

TNT is a white, slightly yellow, or yellowish crystalline solid with a melting point of 80 Celsius. It is insoluble in water, but soluble in acetone, and benzene. It is widely used in the explosives field either by itself, or alloyed with other explosives such as RDX, HMX, or almost any meltable explosive. TNT is also commonly used when mixed with ammonium nitrate for use in military dynamites. TNT is one of the highest volume produced high explosive in the world, and during WWII, so much TNT was made that its preparation was ranked higher by volume than aspirin (180,000+ tones per year). TNT is widely used in grenades, bombs, missiles, demolition charges, and almost every sort of explosive munition imaginable.

Molecular weight: 227.13	Flammability: Burns with smoky flame
Detonating velocity: 6930 (calculated)	Toxicity: Moderate
Sensitivity: Very low (requires nitramine explosive for initiation)	Classification: Secondary explosive
Stability: Very High	Overall value (as secondary explosive): Extremely High

Procedure 11-01A: Preparation of TNT

Materials:	1. 50 grams 99% nitric acid
	2. 858 grams of 30% fuming sulfuric acid
	3. 34 grams of toluene
	4. 108 grams of 70% sulfuric acid
	5. 1500 milliliters of a 5% sodium bicarbonate solution

Summary: TNT can be prepared by reacting toluene with fuming sulfuric acid and 99% nitric acid. Afterwards, the reaction mixture is filtered to recover the TNT crystals. The TNT crystals are then washed with water, and dried. The dried TNT is then purified by mixing it with 70% sulfuric acid. After which, the acidic mixture is then filtered to collect the TNT. The TNT is then washed, and then vacuum dried, or air-dried. Commercial & Industrial Note: Part or parts of this laboratory process may be protected by international, and/or commercial/industrial processes. Before using this process to legally manufacture the mentioned explosive, with intent to sell, consult any protected commercial or industrial processes related to, similar to, or additional to, the process discussed in this procedure. This process may be used to legally prepare the mentioned explosive for laboratory, educational, or research purposes.

Hazards: Warning! 99% Nitric acid is a highly poisonous and corrosive liquid, which evolves highly poisonous fumes of nitrogen oxides. Wear gloves and use proper ventilation when handling 99% nitric acid and 30% fuming sulfuric acid. 30% Fuming sulfuric acid is a highly toxic and corrosive liquid, which evolves toxic and corrosive fumes of sulfur trioxide.

CHAPTER 11: THE PREPARATION OF NITRO BENZENES

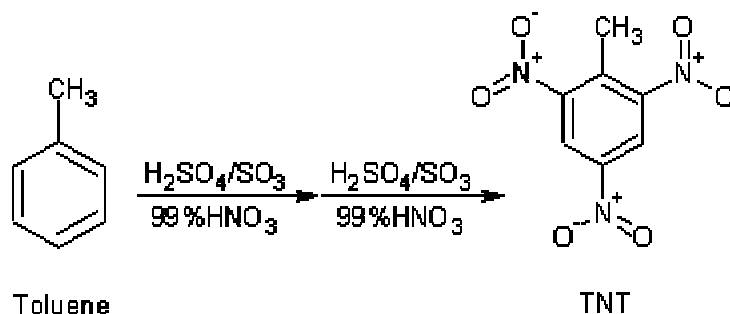
Reaction Equation

Procedure: Place 50 milliliters of 99% nitric acid into a flask, and then carefully add 280 grams of 30% fuming sulfuric acid. Next, place the flask containing the acids into an ice/salt bath and cool to -5 Celsius. When the acid mixture reaches a temperature of about -5 Celsius, slowly add drop-wise, 34 grams of toluene over a period of 100 minutes while rapidly stirring the acid mixture and maintaining its temperature at -5 Celsius. After the addition of the toluene, continue stirring the reaction mixture and maintaining its temperature at -5 Celsius for 30 additional minutes. After 30 minutes, remove the ice/salt bath and allow the reaction mixture to warm to room temperature. Then place the reaction mixture into an ice bath and cool to 0 Celsius. When the temperature of the reaction mixture reaches 0 Celsius, add 572 grams of 30% fuming sulfuric acid over a period of 1 hour while stirring the reaction mixture and maintaining its temperature at 0 Celsius. After the addition of the 30% fuming sulfuric acid, add 100 grams of 99% nitric acid over a period of 1 hour while stirring the reaction mixture and maintaining its temperature at 0 Celsius. After the addition of the 99% nitric acid, remove the ice bath and allow the reaction mixture to warm to room temperature. Then heat the reaction mixture to 70 Celsius for 1 hour. After 1 hour, heat the reaction mixture to 80 Celsius for 30 minutes, and then heat to 90 Celsius for 30 minutes. After heating at 90 Celsius for 30 minutes, pour the hot reaction mixture into a clean flask and allow the reaction mixture to cool to room temperature. After which, place the flask into an ice bath and cool the reaction mixture to 0 Celsius for 1 hour. After 1 hour, filter-off the TNT precipitate, and then place the filtered liquid back into the flask and cool it to -10 Celsius by means of a ice/salt bath. Then keep at -10 Celsius for 1 hour. After 1 hour, filter-off the precipitated TNT using the same filter as before. Then wash all the TNT precipitate with 1000 milliliters of cold water, and then vacuum dry or air dry. **Note:** The filtered liquid (after removal of the TNT by precipitation and filtration) can be recycled for another run of TNT production. To do so, simply forgo the sulfuric acid addition as specified in the procedure, and just add the nitric acid under the same manner as in the procedure. Finally, place 108 grams of 70% sulfuric acid into a beaker, and then add the dry filtered-off TNT product. Then stir the mixture to form a slurry. Continue to stir the slurry for 1 hour at room temperature, and then filter-off the TNT product. Afterwards, wash the TNT with 1500 milliliters of a 5% sodium bicarbonate solution, followed by four 500-milliliter portions of cold water, and then vacuum dry or air-dry the TNT product.

Notes:

Procedure 11-01B: Preparation of TNT

Materials:	1. 920 grams toluene
	2. 2700 grams 99% nitric acid
	3. 3000 grams premium unleaded gasoline
	4. 1600 grams of 70% sulfuric acid
	5. 1500 milliliters of a 5% sodium bicarbonate solution

Summary: TNT can be made by treating toluene with 99% nitric acid in the presence of premium-unleaded gasoline. After the reaction, the TNT is then recovered by recrystallization. The crystallized TNT is collected by filtration, washed, dried, and then purified with 70% sulfuric acid. **Commercial & Industrial Note:** Part or parts of this laboratory process may be protected by international, and/or commercial/industrial processes. Before using this process to legally manufacture the mentioned explosive, with intent to sell, consult any protected commercial or industrial processes related to, similar to, or additional to, the process discussed in this procedure. This process may be used to legally prepare the mentioned explosive for laboratory, educational, or research purposes.

CHAPTER 11: THE PREPARATION OF NITRO BENZENES

Hazards: Warning! Wear gloves and use proper ventilation when handling 99% nitric acid, which is a highly toxic and corrosive liquid evolving highly poisonous fumes of nitrogen oxides. Use great care. Extinguish all flames when handling premium unleaded gasoline, which is highly flammable and volatile.

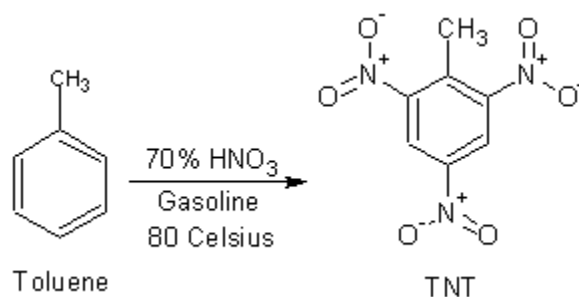

Reaction Equation

Procedure: Place 920 grams of toluene, 2700 grams of 99% nitric acid, and 3000 grams of premium-unleaded gasoline into a flask fitted with stirrer and reflux condenser. Then heat the mixture to about 80 Celsius and reflux for about three hours with constant stirring (do not let the temperature rise above 85 Celsius). In some cases the reaction may take less than three hours, or may take longer. Monitor the nitric acid layer (bottom layer) because the reaction will cease when it disappears. After about three hours, or when the bottom nitric acid layer disappears, shut off the heat and allow the reaction mixture to cool. Upon cooling, some of the TNT begins to precipitate. Instead of filtering off this precipitated TNT, add 3000 milliliters of hot water and stir the whole mixture for about 2 hours. After which, filter off any precipitated TNT, and then decant the upper organic layer. Then place this organic layer into a shallow pan with a high surface area, and allow the upper organic layer to evaporate to recrystallize the bulk of the TNT. When about 80% (by volume) of the upper organic layer has evaporated (heat may be used to speed up the evaporation, but this is not needed due to the volatility of the gasoline), collect the TNT by filtration using the same filter as before, and then wash all the collected TNT product with 2000 milliliters of water. Then dry the TNT in oven at 50 Celsius, or vacuum dry or air-dry the product. Then place 1600 grams of 70% sulfuric acid into a beaker and then add the dry TNT product, and then stir the mixture to form a slurry. Continue to stir the slurry for 2 hours at room temperature and then filter-off the TNT product. Then, wash the TNT with 1500 milliliters of a 5% sodium bicarbonate solution, followed by 2000 milliliters of cold water, and then vacuum dry or air-dry the TNT product.

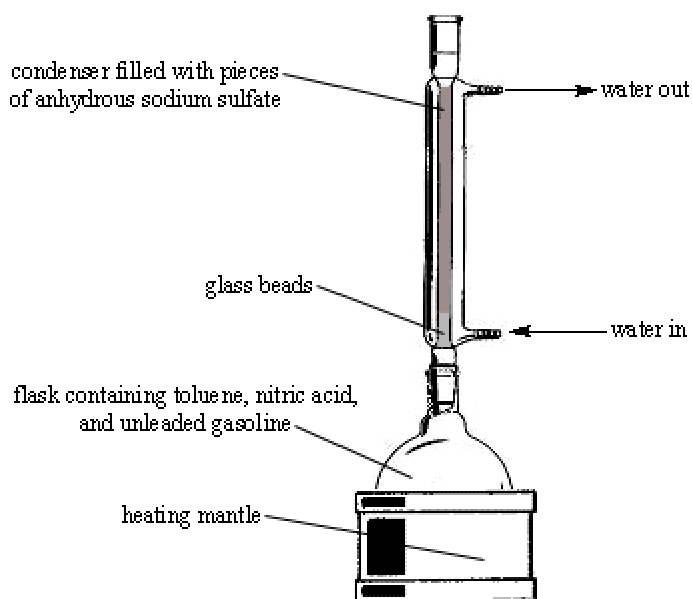

Figure 055. Apparatus for the preparation of TNT.

Notes:

Procedure 11-01C: Preparation of TNT

Materials:	1. 920 grams toluene
	2. 2700 grams 99% nitric acid
	3. 8000 grams methylene chloride
	4. 1600 grams of 70% sulfuric acid
	5. 8404 grams of 98% sulfuric acid
	6. 6000 milliliters of a 5% sodium bicarbonate solution

Summary: TNT can be made by treating toluene with 99% nitric acid in methylene chloride. After the reaction, the TNT is then recovered by recrystallization. The recrystallized TNT is collected by filtration, washed, dried, and then purified with 70% sulfuric acid.

Hazards: Warning! Wear gloves and use proper ventilation when handling 99% nitric acid, which is a highly toxic and corrosive liquid evolving highly poisonous fumes of nitrogen oxides. Use great care. Wear gloves when handling 98% sulfuric acid.

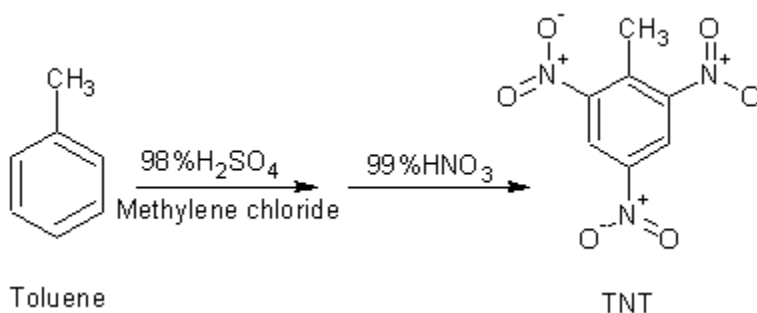
*Reaction Equation*

Procedure: Place 920 grams of toluene, 8404 grams of 98% sulfuric acid, and 8000 grams of methylene chloride into a flask fitted with a stirrer and reflux condenser, and then place the mixture into an ice bath while rapidly stirring the mixture. When the mixture reaches 0 Celsius, slowly add 2700 grams of 99% nitric acid over a period of 2 hours while stirring the mixture and maintaining its temperature at 0 Celsius. After the addition of the 99% nitric acid, remove the ice bath and allow the reaction mixture to warm to room temperature. After which, heat the reaction mixture to 70 Celsius for 2 hours while rapidly stirring the reaction mixture. After 2 hours, raise the temperature of the reaction mixture to 80 Celsius and hold this temperature for 2 hours while rapidly stirring the reaction mixture. Afterwards, remove the heat source and allow the reaction mixture to cool to room temperature. Then add 4000 milliliters of cold water and rapidly stir the reaction mixture for 20 minutes. After which, filter the entire reaction mixture to collect any precipitated TNT, and then decant the upper methylene chloride layer. Then place this methylene chloride layer into a distillation apparatus and distill-off the methylene chloride at 40 Celsius until dry solid remains. When dry solid remains, remove the heat source and allow the flask to cool to room temperature. Afterwards, collect the dry TNT product from the flask and then place onto the filter used earlier. Then wash all the collected TNT product with 1000 milliliters of water. After washing, vacuum dry or air-dry the TNT product. Then place 1600 grams of 70% sulfuric acid into a beaker, and then add the dry TNT product. Then stir the mixture to form a slurry. Continue to stir the slurry for 2 hours at room temperature, and then filter-off the TNT product. Finally, wash the TNT with 6000 milliliters of a 5% sodium bicarbonate solution, followed by 4000 milliliters of cold water, and then vacuum dry or air-dry the TNT product.

Notes:

Procedure 11-01D: Preparation of TNT

CHAPTER 11: THE PREPARATION OF NITRO BENZENES

Materials:	1. 920 grams toluene
	2. 4320 grams of potassium nitrate or 3640 grams of sodium nitrate
	3. 44,000 grams methylene chloride
	4. 1600 grams of 70% sulfuric acid
	5. 16784 grams of 98% sulfuric acid
	6. 10,000 milliliters of a 5% sodium bicarbonate solution

Summary: TNT can be made by reacting a 99% nitric acid/methylene chloride mixture with toluene in the presence of 98% sulfuric acid. The 99% nitric acid/methylene chloride mixture is prepared by extracting a mixture of potassium nitrate or sodium nitrate and sulfuric acid. The reaction mixture is then treated with water, and then filtered to collect any precipitated TNT. The upper methylene chloride layer is then decanted, and evaporated to yield dry solid of TNT. The TNT is then purified by mixing it with 70% sulfuric acid. The acidic mixture is then filtered to collect the TNT, which is then washed with water, and then dried.

Hazards: Wear gloves when handling 98% sulfuric acid and 70% nitric acid, which are both highly corrosive and toxic.

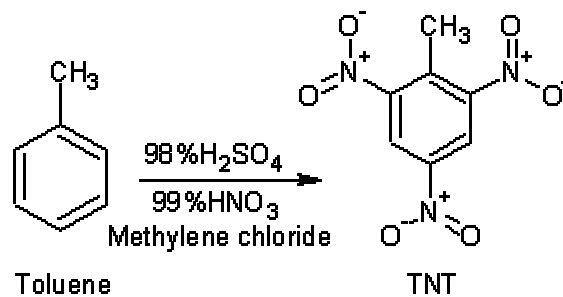

Reaction Equation

Procedure:

Step 1: Preparation of 99% nitric acid/methylene chloride solution

Place 8380 grams of 98% sulfuric acid into a beaker and then place the beaker in a ice bath and cool to 0 Celsius. When the sulfuric acid reaches a temperature of 0 Celsius, slowly add in portions, 4320 grams of potassium nitrate or 3640 grams of sodium nitrate over a period of 2 hours while stirring the 98% sulfuric acid and maintaining its temperature at 0 Celsius. After the addition of the potassium or sodium nitrate, slowly add over a period of one hour, 10,920 milliliters of cold water while continuously stirring the sulfuric acid mixture and maintaining its temperature at 0 Celsius (note: a precipitate may form before or after the addition of the water; if this is the case, never mind it). Afterwards, remove the ice bath and then extract the acid mixture with fourteen 3142-milliliter portions of methylene chloride. Then, combine all fourteen portions of methylene chloride (if not already done so), and then filter the mixture if any insoluble solids are visible.

Step 2: Preparation of TNT

Place the 99% nitric acid/methylene chloride mixture (prepared in step 1) into a beaker, and then add 8404 grams of 98% sulfuric acid. Then cool the mixture to 0 Celsius. When the mixture reaches 0 Celsius, slowly add 920 grams of toluene over a period of 2 hours while rapidly stirring the 98% sulfuric acid/99% nitric acid/methylene chloride mixture and maintaining its temperature at 0 Celsius. After the addition of the toluene, remove the ice bath and allow the reaction mixture to warm to room temperature. After which, heat the reaction mixture to 70 Celsius for 2 hours while rapidly stirring the reaction mixture. After 2 hours, raise the temperature of the reaction mixture to 80 Celsius and hold this temperature for 2 hours while rapidly stirring the reaction mixture. Afterwards, remove the heat source, and allow the reaction mixture to cool to room temperature. After which, add 8000 milliliters of cold water and rapidly stir the whole mixture for 30 minutes. Then, filter the reaction mixture to collect any precipitated TNT, and then decant the upper methylene chloride layer. Then pour this methylene chloride layer into a distillation apparatus and distill-off the methylene chloride at 40 Celsius until dry solid remains. When dry solid remains, remove the heat source and allow the flask to cool to room temperature. After which, collect the dry TNT product from the flask, and then place onto the filter used earlier. Then, wash all the collected TNT product with 2000 milliliters of water. After washing, vacuum dry or air-dry the TNT product. Then place 1600 grams of 70% sulfuric acid into a beaker, and then add the dry TNT product. Afterwards, stir the mixture to form a slurry. Continue to stir the slurry for 2 hours at room temperature, and then filter-off the TNT product. Then wash the TNT with 10,000 milliliters of a 5% sodium carbonate solution, followed by 6000 milliliters of cold water, and then vacuum dry or air-dry the TNT product.

Notes:

Procedure 11-01E: Preparation of TNT

Materials:	1. 920 grams toluene
	2. 3820 grams 70% nitric acid
	3. 8404 grams of 98% sulfuric acid
	4. 1600 grams of 70% sulfuric acid
	5. 1500 milliliters of a 5% sodium carbonate solution

Summary: TNT can be made by reacting toluene with a nitrating acid prepared by mixing 70% nitric acid with 98% sulfuric acid. The reaction mixture is then mixed with excess water, and the TNT precipitate is collected by filtration, washed, and then dried. The dry crude TNT is then purified by treatment with 70% sulfuric acid to form a slurry. The slurry is then filtered to recover the TNT, which is then washed with cold water, and then dried to yield high purity TNT.

Hazards: Same as procedure 11-01D.

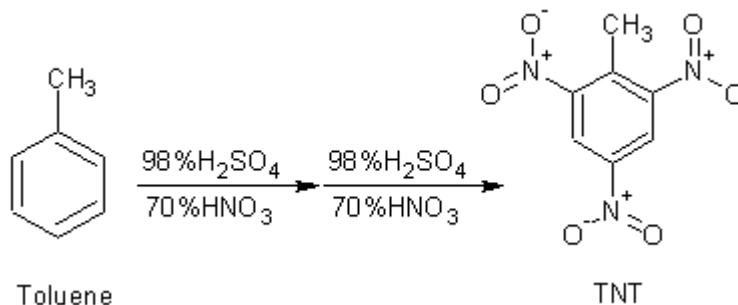

Reaction Equation

Procedure: Place 3820 grams of 70% nitric acid into a beaker, and then gradually add over a period of 2 hours, 8404 grams of 98% sulfuric acid. Then place the beaker into a cold-water bath and cool to 10 to 15 Celsius. When the acid mixture reaches a temperature of about 10 to 15 Celsius, pour 1910 milliliters of this acid mixture into a clean separate beaker, and then cool to 10 to 15 Celsius by means of a cold water bath. When the temperature of this 1910-milliliter portion of acid mixture reaches 10 to 15 Celsius, slowly add 920 grams of toluene over a period of 4 hours while rapidly stirring the acid mixture and maintaining its temperature at 10 to 15 Celsius. After the addition of the toluene, continue stirring the reaction mixture for an additional 2 hours while keeping the reaction temperature at 10 to 15 Celsius. After which, add the remaining acid mixture obtained at the start of the procedure, to the reaction mixture and then after the addition, raise the temperature of the reaction mixture to 70 Celsius, and hold this temperature while rapidly stirring the reaction mixture for 2 hours. After 2 hours, raise the temperature to 80 Celsius, and heat at 80 Celsius for 2 hours while rapidly stirring the reaction mixture. After heating the reaction mixture to 80 Celsius for 2 hours, remove the heat source, and allow the reaction mixture to cool to room temperature. Then add the entire reaction mixture to 5000 milliliters of cold water, and then filter-off the precipitated TNT product. After which, wash the TNT precipitate with 2000 milliliters of water, and then vacuum dry or air-dry the TNT precipitate. Then, place 1600 grams of 70% sulfuric acid into a beaker, and then add the dry TNT product. Afterwards, stir the mixture to form a slurry. Continue to stir the slurry for 2 hours at room temperature, and then filter-off the TNT product, wash with 1500 milliliters of a 5% sodium bicarbonate solution, followed by 2000 milliliters of cold water, and then vacuum dry or air-dry the TNT product.

Notes:

Place 200 grams of TNT into a beaker, and then heat to 90 Celsius. When the TNT melts, maintain the molten TNT at 90 Celsius while stirring, and then add in order, the following ingredients: 1) 1.3 grams of polybutadiene homopolymer liquid resin, marketed under the tradename Poly bd Liquid Resin R-45 A, by the ARCO Chemical Company; then 2) 1.6 grams of a mixture of dehydroabietyl alcohols, sold under the trademark Abitol by the Hercules Chemical Company; then 3) 400 milligrams of epichlorohydrin, marketed by the Shell Chemical Company as "Epon 828"; then 4) 1.6 grams of "Adiprene" L-100. After the addition of the ingredients, continue heating at 90 Celsius with stirring for 2 hours. After 2 hours, pour the molten mixture into any desirable mold, container, bomb casing, or warhead casing under pressure (the container should be able to withstand a temporary temperature of 90 Celsius), and then allow it to cure for several days. For demolitions use, remove the explosive from its mold or container after several days, and then wrap in paper, plastic, or cardboard. Commercial & Industrial Note: For related, or similar information, see Application No. 664,798, March 8, 1976, by The United States Army, to William H. Voigt, Jr., Stanhope, NJ, Lawrence W. Pell, St. Simon's Island, GA, and Jean P. Picard, Morristown, NJ. Part or parts of this laboratory process may be protected by international, and/or commercial/industrial processes. Before using this process to legally manufacture the mentioned explosive, with intent to sell, consult any protected commercial or industrial processes related to, similar to, or additional to, the process discussed in this procedure. This process may be used to legally prepare the mentioned explosive for laboratory, educational, or research purposes.

TNT 20/80 blasting explosive "composition A2"

Mix 200 grams of Estane 5702 into 3000 milliliters of methyl ethyl ketone, and then allow the mixture to stand overnight at room temperature. Afterwards, manually stir the mixture to dissolve the Estane 5702. After the Estane 5702 has dissolved, add 800 grams of TNT. During the addition of the TNT, stir the mixture rapidly until all the TNT is dissolved. After the TNT is dissolved, prepare a solution by dissolving 5 grams of STR-2 powder (marketed by the St. Regis Paper Co., of New York) into 15,000 milliliters of cold water. Then, add the TNT mixture while rapidly stirring the cold water. After the addition, continue stirring the cold-water mixture for 1 hour, and then filter-off the composition A2 precipitate. After which, wash the filtered-off precipitate with four 2-liter portions of cold water, and then dry the precipitate in an oven at 70 Celsius. The dry product mixture thus obtained will be in the form of uniform, free-flowing granules. The explosive composition can then be used directly as granules, or pressed into any desirable mold, container, bomb casing, or warhead casing under high pressure. For demolitions use, after pressing the explosive into any desirable mold or container, remove the explosive from the mold or container and then wrap in plastic, paper, or cardboard. The mold or container should be 1 – 2 inches wide by 5 – 11 inches long. For making military dynamite, simply press the explosive into a cardboard tube as illustrated in figure 056. Requires a blasting cap or detonator for initiation. Commercial & Industrial note: For related, or similar information, see Application No. 104,499, December 17, 1979, by The United States Army, to H. William Voigt, Jr., Wharton, NJ, and Bernard R. Banker, Mine Hill, NJ. Part or parts of this laboratory process may be protected by international, and/or commercial/industrial processes. Before using this process to legally manufacture the mentioned explosive, with intent to sell, consult any protected commercial or industrial processes related to, similar to, or additional to, the process discussed in this procedure. This process may be used to legally prepare the mentioned explosive for laboratory, educational, or research purposes.



Figure 056. Illustration of US military dynamite. See FM 43-0001-38 for additional information.

TNT-wax castable explosive

Step 1: Preparation of wax composition

Place 170 grams of ozokerite wax into a 500-milliliter beaker and then heat to 90 Celsius to melt the wax. After the wax has melted, add 2 grams of dry lecithin. Afterwards, raise the temperature to 110 Celsius. Then, rapidly stir the molten mixture at 110 Celsius for 90 minutes. After 90 minutes, cool the mixture to 90 Celsius. Then prepare a nitrocellulose mixture by mixing

CHAPTER 11: THE PREPARATION OF NITRO BENZENES

2 grams of methanol with 30 grams of nitrocellulose, and then add this mixture to the molten wax mixture. After the addition, continue stirring the molten mixture for 40 minutes at 90 Celsius. After which, raise the temperature to 110 Celsius and stir for 40 minutes. After 40 minutes, pour the molten mixture into a shallow pan and allow it to cool. After the wax mixture as solidified, break it up into tiny pieces.

Step 2: Preparation of Explosive Composition

Place 132 grams of TNT into a 300-milliliter beaker and then heat the beaker to 84 Celsius. Then place 36 grams of aluminum powder into a beaker and heat to 80 Celsius. When the TNT has melted, add 32 grams of the wax composition pieces (prepared in step 1) to the melted TNT, and stir rapidly until an emulsion forms. When the emulsion forms, add 36 grams of the heated aluminum powder, and then thoroughly mix the aluminum into the TNT/wax mixture. Afterwards, continue stirring the molten mixture at 84 Celsius for thirty minutes, and then pour the molten mixture into any desirable mold, container, bomb casing, or warhead casing and then cure for several days. For demolitions purposes, remove the mold or container and then wrap the explosive composition in paper, plastic, or cardboard. The mold or container should be 1 – 2 inches wide by 5 – 11 inches long. Requires a blasting cap or detonator for initiation. Commercial & Industrial note: For related, or similar information, see Application No. 925,960, November 3, 1986, by Stephen A. Aubert, Niceville, FL. Part or parts of this laboratory process may be protected by international, and/or commercial/industrial processes. Before using this process to legally manufacture the mentioned explosive, with intent to sell, consult any protected commercial or industrial processes related to, similar to, or additional to, the process discussed in this procedure. This process may be used to legally prepare the mentioned explosive for laboratory, educational, or research purposes.

“Hexotonol” RDX/TNT explosive

Place 50 liters of water into a large container, and then heat the water to 90 Celsius while stirring. When the water reaches 90 Celsius, add 8 kilograms of RDX and then add 1.2 grams of oxazolin wax, and then stir the mixture rapidly for 1 hour. After 1 hour, add 1000 grams of wax (designated Wax Composition 1), and continue heating and stirring for 1 hour. After which, reduce the temperature to 80 Celsius and then add 1600 grams of TNT while stirring the mixture rapidly for 1 hour. Thereafter, reduce the temperature to 70 Celsius. Then place 6.4 kilograms of TNT into a beaker and heat to 90 Celsius to melt it. When the TNT has melted, add 3 kilograms of aluminum powder, and thoroughly mix for 1 hour. Afterwards, pour the molten TNT mixture into the RDX/TNT/wax mixture and then stir the entire mixture for 1 hour. After 1 hour, filter-off the explosive granules, and then place the granules on a tray and allow them to dry for several days. To use the explosive, heat the dry granules in a beaker at 90 Celsius until molten. When the granules have melted, pour the molten explosive into any desirable mold, container, bomb casing or warhead casing, and allow solidifying. For demolition purposes, remove the solidified explosive from the container, and then wrap in plastic, paper, or cardboard. Instead of melting the granules, the freshly prepared explosive granules can be pressed under high pressure into any desirable mold, container, bomb casing, or warhead casing. For demolitions use, the mold or container should be 1 – 2 inches wide by 5 – 11 inches long. Requires a blasting cap or detonator for initiation. Commercial & Industrial Note: Part or parts of this laboratory process may be protected by international, and/or commercial/industrial processes. Before using this process to legally manufacture the mentioned explosive, with intent to sell, consult any protected commercial or industrial processes related to, similar to, or additional to, the process discussed in this procedure. This process may be used to legally prepare the mentioned explosive for laboratory, educational, or research purposes.

“Octol” TNT/Ammonium nitrate explosive

Into a large beaker, place 1200 grams of freshly prepared TNT, and then add 800 grams of dry ammonium nitrate granules (the granules should be about 1 to 2 millimeters in diameter). Thereafter, thoroughly blend the mixture for 1 hour at room temperature. Afterwards, add 5 liters of hot water, and then carefully heat the mixture to 50 Celsius, and then continue stirring for 2 hours. After heating and stirring at 50 Celsius for 2 hours, add 20 grams of standard candle wax, i.e., paraffin wax, and then continue heating at 50 Celsius while stirring for 1 hour. After which time, remove the heat source, and allow the mixture to cool to room temperature. Then place the whole mixture onto a large shallow pan, and allow it to dry. When a dry solid mixture remains, take the dry solid and pulverize it into a coarse powder. Then thoroughly blend this mixture for 1 hour to form a uniform solid mixture. Thereafter, add 50 grams of lubricating oil (the oil may be any motor oil, cooking oil, or petroleum oil), and then manually blend the whole mixture for 2 hours at room temperature. To use the explosive, simply pack it into any desirable mold, bomb casing, or warhead casing under high pressure. For use in shape charges, simply pack it into the desired warhead under high pressure. Note: Octol is well suited for shape charges due to the excessive amount of gas produced by the proper detonation of ammonium nitrate. Requires a blasting cap or detonator for initiation.

Examples of TNT explosive munitions

Fragmenting grenades are common explosive munitions used in warfare. There are many types and sizes of fragmenting grenades, but they all function in a similar manner. Grenades are activated in series of steps beginning with the obvious, the pulling of the safety pin. When the safety pin is released, nothing happens unless the pressure on the safety lever is released (the pressure on the safety lever is maintained by the throwers hand). When this happens, a spring-loaded striker pin rotates over, throwing the safety lever clear, and then striking a primer located on the top of the grenade. The primer ignites a delay element composed of black powder. The delay element can take anywhere from 2 seconds to 10 seconds to burn down to the detonator, depending on the type of grenade fuse. The detonator is nothing more than a simple blasting cap similar to figures 044 and 045. The following munitions include a standard grenade fuse (left illustration), and a standard military grenade (right illustration). In the left illustration, the grenade fuse represents a standard grenade fuse, and is not used in the grenade illustrated on the right. The grenade fuse in the left illustration is composed of a safety lever, striker pin, primer, and detonator. As described above, when the grenade is thrown, the striker pin rotates over, and strikes a primer. The primer initiates the delay element, composed of a standard black powder fuse. The black powder fuse burns down to the priming mixture, composed of the usual ingredients. The primer mixture initiates the booster charge, composed of lead azide. The lead azide in turn detonates the base charge of RDX. The base charge of RDX detonates the main charge, composed of TNT. In the right illustration, a cut-away view of a standard military grenade is disclosed. When the main charge of TNT detonates, it shatters the cast iron layer, and the steel body, producing fragments of various sizes. These fragments are thrown in many directions with lethal force. Most fragmentation grenades have a casualty radius of about 5 meters. This means that any exposed personnel within the 5-meter radius have a 90% chance of getting hit by fragmentation, and the killing percentage is about 60% within the 5 meters. Within 2 meters of the grenade, the killing percentage is about 90%. Beyond the 5 meter radius, the chance of any exposed personnel getting hit by lethal fragments is less than 30% up to 10 meters, and less than 10% up to 30 meters. Due to the physics of flying fragments, as it corresponds with the amount of explosive used, the strength of the explosive, and the thickness and type of fragmentation used, the flying fragments will not reach a distance of more than 50 meters, 98% of the time.

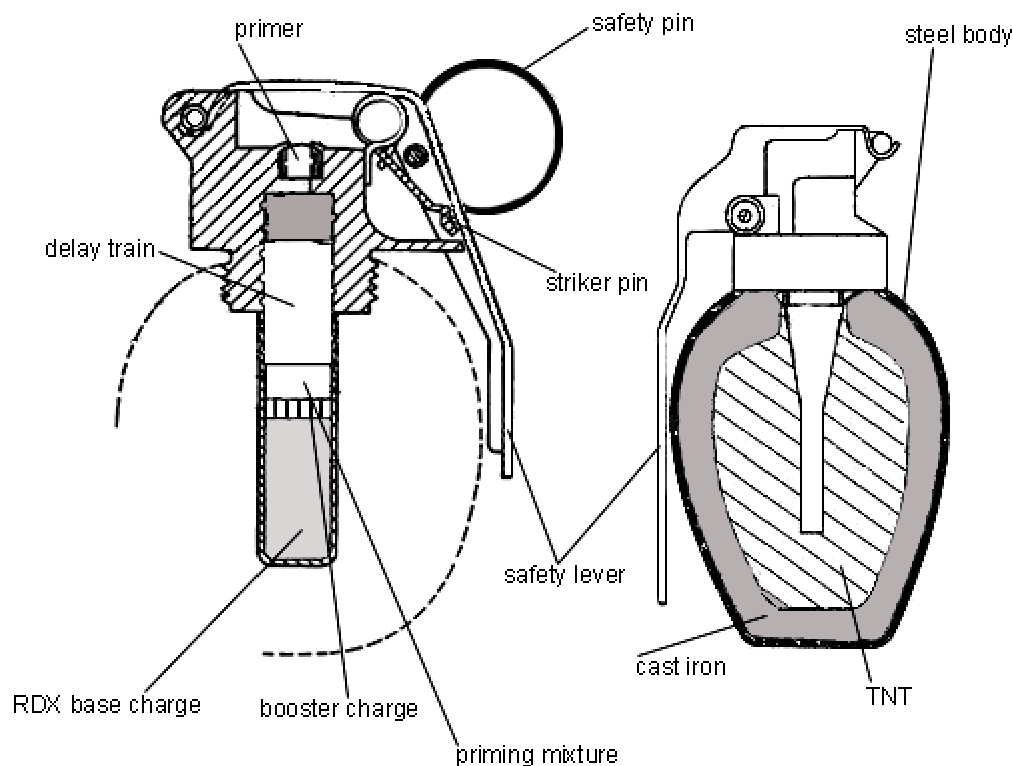
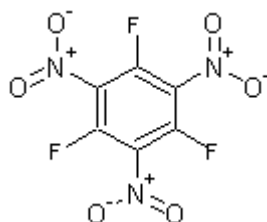

Figure 057. Left illustration: Grenade fuse. Right illustration: Standard military grenade.

11-02. F-TNB. *1,3,5-trifluoro-2,4,6-trinitrobenzene*



F-TNB

Use: Intermediate in the preparation of other high explosives.

Molecular weight: 267.076	Flammability: Burns with smoky flame
Detonating velocity: Uncalculated	Toxicity: Moderate
Sensitivity: Low	Classification: Secondary explosive
Stability: Very good	Overall value (as secondary explosive): High

Procedure 11-02A: Preparation of F-TNB

Materials:	1. 2400 milliliters 30% fuming sulfuric acid
	2. 560 grams potassium nitrate
	3. 112 grams 1,3,5-trifluorobenzene
	4. 2400 milliliters methylene chloride
	5. 600 milliliters hexanes
	6. 20 grams crushed charcoal
	7. 40 grams anhydrous sodium sulfate

Summary: In some nitrations, potassium nitrate can be used as the nitrating agent instead of nitric acid. The potassium nitrate is mixed with 30% fuming sulfuric acid, which ultimately forms nitric acid in solution. This nitric acid then nitrates trifluorobenzene, producing F-TNB. Commercial & Industrial note: For related, or similar information, see Application No. 937,281, August 28, 1978, by The United States Navy, to William M. Koppes, Adelphi, MD, Horst G. Adolph, Silver Spring, MD, and Michael E. Sitzmann, Adelphi, MD. Part or parts of this laboratory process may be protected by international, and/or commercial/industrial processes. Before using this process to legally manufacture the mentioned explosive, with intent to sell, consult any protected commercial or industrial processes related to, similar to, or additional to, the process discussed in this procedure. This process may be used to legally prepare the mentioned explosive for laboratory, educational, or research purposes.

Hazards: Wear gloves and use proper ventilation when handling 30% fuming sulfuric acid. 30% fuming sulfuric acid is a highly corrosive, fuming liquid evolving poisonous fumes of sulfur trioxide. Handle with great care. Hexane is a highly flammable, volatile liquid. Do not smoke when handling hexane.

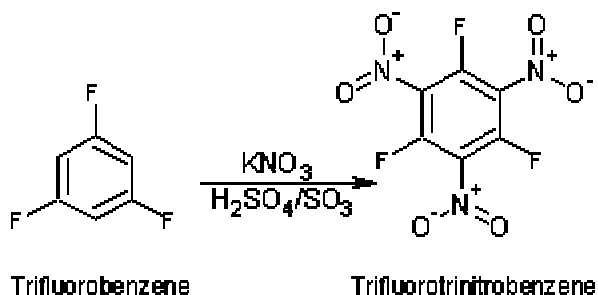

Reaction Equation

Procedure: Place 2400 milliliters of 30% fuming sulfuric acid into a 6-liter 3-neck flask equipped with a stirrer, condenser, and thermometer. Then cool to 0 Celsius using an ice bath. When the temperature of the 30% fuming sulfuric acid reaches 0 Celsius, slowly add, in small portions, 560 grams of potassium nitrate while keeping the temperature of the 30% fuming sulfuric acid below 50 Celsius and stirring. After the addition of the potassium nitrate, remove the flask from the ice bath and then heat the flask to 50 Celsius. Afterwards, slowly add 112 grams of 1,3,5-trifluorobenzene while maintaining the reaction

CHAPTER 11: THE PREPARATION OF NITRO BENZENES

temperature at 50 Celsius. After the addition of the 1,3,5-trifluorobenzene, reflux the reaction mixture at 153 Celsius for 72 hours. After refluxing for 72 hours, allow the reaction mixture to cool to room temperature, and then extract the reaction mixture with six 400-milliliter portions of methylene chloride. After the extraction process, combine all 400-milliliter portions, and then place into a distillation apparatus. Then distill at 40 Celsius until the total volume of the remaining methylene chloride in the distillation flask equals 500 milliliters. When this volume is achieved, remove the heat source, and then allow the remaining methylene chloride in the distillation flask to cool to room temperature. After which, add 40 grams of anhydrous sodium sulfate (to absorb water), and then shake the mixture for about 20 minutes. Thereafter, filter-off the sodium sulfate, and then heat the filtered mixture to about 50 Celsius. Then add 300 milliliters of hexane, and continue heating the mixture at 50 Celsius for ten minutes. After which, remove the heat source, but before the mixture cools, add 20 grams of crushed charcoal (to absorb impurities), and stir the whole mixture for ten minutes. After stirring for ten minutes, filter-off the charcoal. Then place the mixture into a distillation apparatus, and distill at 40 Celsius until no more methylene chloride is collected in the receiver flask. Afterwards, filter the remaining liquid in the distillation flask hot, and then add 300 milliliters of hexane. Then stir the mixture for ten minutes. After stirring for ten minutes, place the liquid into a shallow pan, and allow it to evaporate to yield dry solid. After the evaporation is complete, recover the dry crystals of F-TNB.

Notes:

11-03. TCTNB. *Trichlorotrinitrobenzene; 1,3,5-trichloro-2,4,6-trinitrobenzene*

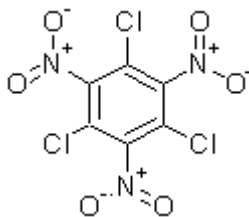

TCTNB

Use: Intermediate in the manufacture of other high explosives, and as an ingredient in demolition charges, and rocket propellants—increases thrust by providing chlorine, but increases smoke trails.

Molecular weight: 316.439	Flammability: Burns with smoky flame
Detonating velocity: Uncalculated	Toxicity: Moderate
Sensitivity: Low	Classification: Secondary explosive
Stability: Very good	Overall value (as secondary explosive): Moderate

Procedure 11-03A: Preparation of TCTNB

Materials:	1. 68 grams 1,3,5-trichlorobenzene
	2. 100 grams 70% nitric acid
	3. 110 grams 98% sulfuric acid

Summary: TCTNB is prepared by reacting trichlorobenzene with a nitrating acid mixture composed of nitric and sulfuric acids. The resulting product is then filtered, washed with water, dried, and then recrystallized from benzene. Commercial & Industrial note: Part or parts of this laboratory process may be protected by international, and/or commercial/industrial processes. Before using this process to legally manufacture the mentioned explosive, with intent to sell, consult any protected commercial or industrial processes related to, similar to, or additional to, the process discussed in this procedure. This process may be used to legally prepare the mentioned explosive for laboratory, educational, or research purposes.

Hazards: Wear gloves when handling 70% nitric acid and 98% sulfuric acid. 98% sulfuric acid can cause severe skin burns, and 70% nitric can cause tissue damage due to its strong oxidizing nature. Use care.

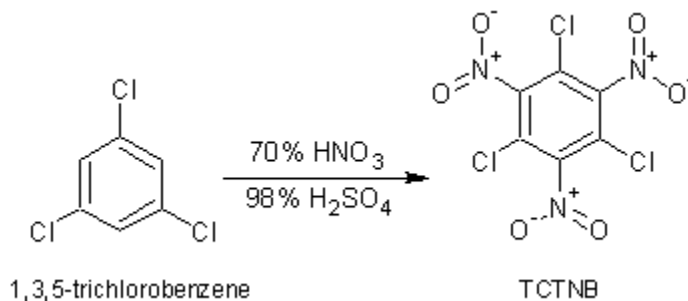
*Reaction Equation*

Procedure: Prepare a nitrating acid mixture by adding 110 grams of 98% sulfuric acid into 100 grams of 70% nitric acid (always add the sulfuric to the nitric, and never the reverse). Then cool the acid mixture to 20 Celsius using a cold-water bath, and stir. Then slowly add 1,3,5-trichlorobenzene, in small portions, over a period of 2 hours while stirring the acid mixture and keeping the acid mixture at 20 Celsius. After the addition of the trichlorobenzene, heat the reaction mixture to 40 Celsius for 2 hours with strong stirring. After 2 hours, cool the reaction mixture to room temperature, and then pour the entire reaction mixture into 1000 milliliters of cold water. Afterwards, filter-off the precipitated product, and wash with 1000 milliliters of cold water several times. After washing the product with water, vacuum dry or air-dry. Next, recrystallize the product from 400 grams of benzene, and then wash with 1000 milliliters of cold water, and then vacuum dry or air-dry the product. During the recrystallization process, do not evaporate all the benzene. The last of the remaining benzene during the recrystallization process will contain dissolved impurities, which are more soluble in benzene than TCTNB (in other words, remove only 85% of the benzene by volume during the recrystallization process. The remaining volume of 15% will contain mostly dissolved by-products, and can be recycled for the next recrystallization of TCTNB if desired.

Notes:

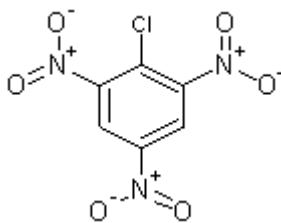
11-04. Picryl Chloride. 1-chloro-2,4,6-trinitrobenzene

Picryl chloride

Uses: Intermediate in the preparation of other high explosives, and in explosives charges with TNT, or TATB.

Molecular weight: 247.549	Flammability: Burns with smoky flame
Detonating velocity: Uncalculated	Toxicity: Moderate
Sensitivity: Low	Classification: Secondary explosive
Stability: Very good	Overall value (as secondary explosive): Moderate

Procedure 11-04A: Preparation of Picryl chloride

Materials:	1. 160 grams chlorobenzene
	2. 710 grams potassium nitrate
	3. 1600 milliliters 30% fuming sulfuric acid
	4. 200 milliliters acetone
	5. 600 milliliters methanol

Summary: Picryl chloride is prepared by treating chlorobenzene with potassium nitrate and fuming sulfuric acid. The picryl chloride is then precipitated, washed with water, and then dried. The picryl chloride is then purified by recrystallization from an acetone/methanol mixture. Commercial & Industrial Note: Part or parts of this laboratory process may be protected by international, and/or commercial/industrial processes. Before using this process to legally manufacture the mentioned explosive, with intent to sell, consult any protected commercial or industrial processes related to, similar to, or additional to, the process discussed in this procedure. This process may be used to legally prepare the mentioned explosive for laboratory, educational, or research purposes.

Hazards: Wear gloves and use proper ventilation when handling 30% fuming sulfuric acid, which is a highly toxic and corrosive liquid evolving toxic fumes of sulfur trioxide. Use great care. Wear gloves and use proper ventilation when handling chlorobenzene. Chlorobenzene is a highly irritating substance. Avoid skin contact and eye contact. Use proper ventilation and do not smoke when handling acetone and methanol. Acetone and methanol are highly volatile and flammable liquids.

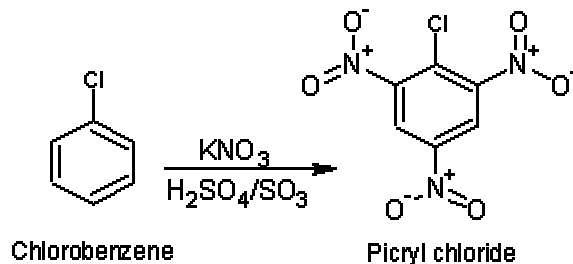

Reaction Equation

Procedure: Place 1600 milliliters of 30% fuming sulfuric acid into a 4-liter flask equipped with a stirrer, thermometer, and condenser. Then place the flask into a cold-water bath, and then slowly add 710 grams of potassium nitrate while stirring the fuming sulfuric acid and keeping its temperature below 60 Celsius. After the addition of the potassium nitrate, allow the solution to cool to about 30 Celsius (if necessary), and then slowly add 160 grams of chlorobenzene while stirring the reaction mixture, and keep its temperature below 50 Celsius. After the addition of the chlorobenzene, remove the cold-water bath, and then reflux the reaction mixture at 125 Celsius for 4 hours. After refluxing for 4 hours, remove the heat source, and allow the reaction mixture to cool to room temperature. After which, add the reaction mixture to 1000 grams of ice contained in a 3000 milliliter beaker. After the ice has melted, add 1000 milliliters of cold water, and stir the entire mixture for 20 minutes. Then filter-off the precipitated product, wash with two 500-milliliter portions of cold-water, and then vacuum dry or air-dry the product. After drying, dissolve the product in 200 milliliters of acetone, and after the entire product has dissolved, add 600 milliliters of methanol. Finally, recrystallize the product from this solvent mixture. After recrystallization, wash the product with two 200-milliliter portions of cold water, and then vacuum dry or air-dry the product.

Notes:

11-05. TNBCl. *Trinitrobenzylchloride*

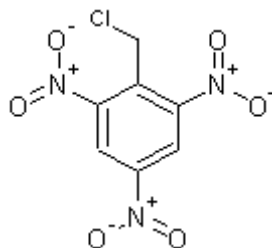

TNBCl

Uses: As an intermediate in the preparation of other high explosives, and in explosives compositions with TNT or RDX.

CHAPTER 11: THE PREPARATION OF NITRO BENZENES

Molecular weight: 261.576	Flammability: Burns with smoky flame
Detonating velocity: Uncalculated	Toxicity: Moderate
Sensitivity: Low	Classification: Secondary explosive
Stability: Very good	Overall value (as secondary explosive): Moderate

Procedure 11-05A: Preparation of TNBCl

Materials:	1. 20 grams TNT
	2. 200 milliliters 5% sodium hypochlorite (bleach) (<i>commercially available; clorox</i>)
	3. 200 milliliters tetrahydrofuran (THF)
	4. 100 milliliters methanol
	5. 20 milliliters 35 – 38% hydrochloric acid

Summary: TNBCl is easily prepared by quickly adding a TNT solution to a 5% sodium hypochlorite solution, and then quickly adding dilute hydrochloric acid to stop the reaction and eliminate side reactions. The solution is then allowed to stand for 1 hour, and then filtered to collect the product. The product is washed, and then dried. Commercial & Industrial Note: Part or parts of this laboratory process may be protected by international, and/or commercial/industrial processes. Before using this process to legally manufacture the mentioned explosive, with intent to sell, consult any protected commercial or industrial processes related to, similar to, or additional to, the process discussed in this procedure. This process may be used to legally prepare the mentioned explosive for laboratory, educational, or research purposes.

Hazards: Wear gloves and use proper ventilation when handling 35 – 38% hydrochloric acid, which is a highly corrosive and toxic liquid evolving toxic and corrosive fumes.

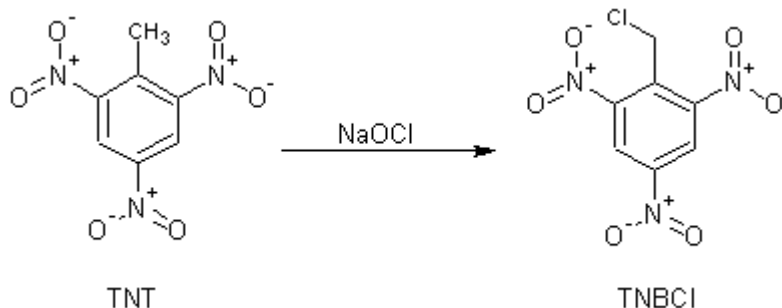
*Reaction Equation*

Procedure: Place 200 milliliters of THF and 100 milliliters of methanol into a flask, and then add 20 grams of TNT while stirring the THF/methanol mixture. Then cool the solution to 0 Celsius by means of an ice bath. Then place 200 milliliters of a 5% sodium hypochlorite solution into a large flask, and then cool to 0 Celsius by means of an ice bath. Now, prepare a dilute hydrochloric acid solution by adding 20 milliliters of 35 – 38% hydrochloric acid into 2000 milliliters of water. When the 5% sodium hypochlorite solution reaches 0 Celsius, quickly add all of the THF/methanol/TNT mixture while stirring the 5% sodium hypochlorite solution, and maintain its temperature below 15 Celsius. As soon as the THF/methanol/TNT mixture has been added to the 5% sodium hypochlorite solution, wait exactly 1 minute, and then stop the reaction by quickly adding the dilute hydrochloric acid solution while stirring the reaction mixture (waiting longer than 1 minute will cause a secondary side reaction). After the addition of the dilute hydrochloric acid solution, allow the reaction mixture to stand at 0 Celsius for about 2 hours while stirring. After 1 hour, filter-off the product, wash with six 200-milliliter portions of cold water, and then vacuum dry or air-dry the product. The result will be 20 grams of trinitrobenzylchloride with a melting point of 85 Celsius.

Notes:

CHAPTER 12: THE PREPARATION OF POLY NITRO BENZENES

HNB, HNS, TNTPB, PNT, HNBP, HEXADITON, TNN

12-01. Hexol. Hexanitrobibenzyl; 2,2', 4,4', 6,6'-hexanitrobibenzyl

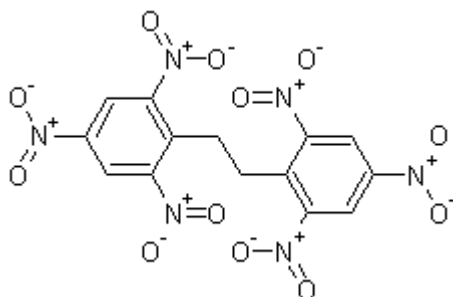

HNB

HNB is a light colored crystalline solid with a melting point of 218 Celsius. It has similar properties to HNS, and can be used as a substitute, or in combination with HNS for explosives compositions. HNB can be used by itself or alloyed with RDX for filling shells and bombs. HNB demonstrates outstanding resistance to shock, percussion, heat, and friction.

Molecular weight: 452.247	Flammability: Burns with smoky flame
Detonating velocity: 7800 (estimated)	Toxicity: Moderate
Sensitivity: Very low	Classification: Secondary explosive
Stability: Very good	Overall value (as secondary explosive): Moderate

Procedure 12-01A: Preparation of HNB

Materials:	1. 20 milliliters benzene
	2. 260 milliliters methanol
	3. 20 grams TNT
	4. 1 gram sodium hydroxide
	5. 70 milliliters 5% sodium hypochlorite solution

Summary: HNB is prepared by reacting TNT with sodium hypochlorite solution in the presence of methanol, and benzene. The reaction mixture is then filtered to remove the precipitated HNB, which is then washed with methanol, and dried. Commercial & Industrial note: For related, or similar information, see Application No. 079,128, January 27th, 1981, by The United States Army, to Everett E. Gilbert, Morristown, NJ. Part or parts of this laboratory process may be protected by international, and/or commercial/industrial processes. Before using this process to legally manufacture the mentioned explosive, with intent to sell, consult any protected commercial or industrial processes related to, similar to, or additional to, the process discussed in this procedure. This process may be used to legally prepare the mentioned explosive for laboratory, educational, or research purposes.

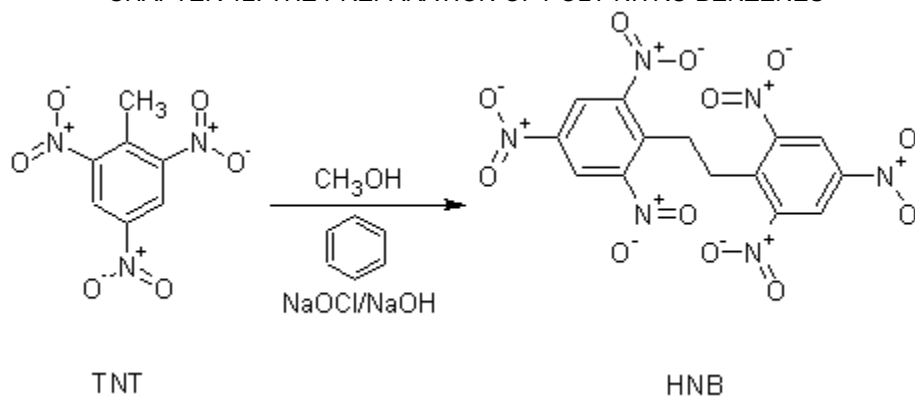
*Reaction Equation*

Hazards: Benzene is a known carcinogen; use proper ventilation and avoid inhalation of vapors.

Procedure: Prepare a solution by dissolving 20 milliliters of benzene into 160 milliliters of methanol. Then add 20 grams of TNT, and stir the mixture. Afterwards, gently heat the mixture to 40 Celsius to completely dissolve the TNT. While gently heating the mixture to 40 Celsius, prepare a solution by dissolving 1 gram of sodium hydroxide into 70 milliliters of 5% sodium hypochlorite solution. When the TNT mixture reaches 40 Celsius, gradually add drop wise, the sodium hypochlorite mixture while stirring the TNT mixture and maintaining its temperature at 40 Celsius. The addition of the sodium hypochlorite mixture should not take long. After the addition of the sodium hypochlorite mixture, stir the mixture at 40 Celsius for 1 hour. After which, remove the heat source and allow the reaction mixture to cool to room temperature. Afterwards, filter-off the precipitated product, wash with 100 milliliters of methanol, and then vacuum dry or air-dry the product. The result will be 15 grams of HNB in the form of light colored crystals.

Notes:

12-02. HNS. *Hexanitrostilbene*

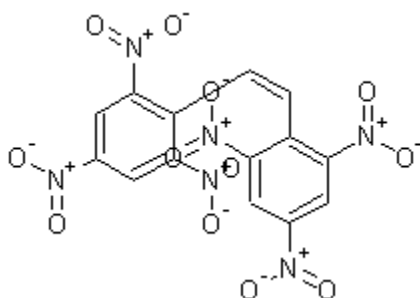

HNS

HNS forms white to tan to lightly yellow crystals with a melting point of 312 Celsius. It is a powerful explosive used in high performance explosive compositions for demolitions, warheads, and other charges. It demonstrates outstanding resistance to shock, percussion, heat, and friction. Because of its high melting point, it has excellent thermal stability, making it well suitable for intercontinental missile warheads or components, artillery shells, rockets, and high velocity explosives projectiles. HNS is also widely used in warheads for air-to-ground missiles, air-to-air missiles, and cruise missiles. As with all poly nitro explosives, HNS should not be detonated in very poor ventilated areas as poisonous fumes of nitrogen oxides are produced.

Molecular weight: 450.231	Flammability: Burns with smoky flame
Detonating velocity: 7800 (estimated) also 7300 (estimated)	Toxicity: Moderate
Sensitivity: Very low	Classification: Secondary explosive

Stability: Very good

Overall value (as secondary explosive): Very high

Procedure 12-02A: Preparation of HNS

Materials:	1. 15.6 grams trinitrobenzyl chloride
	2. 13.8 grams triethylbenzyl ammonium chloride
	3. 210 milliliters methylene chloride
	4. 2.4 grams sodium hydroxide
	5. 200 milliliters of methanol

Summary: HNS is prepared by treating the high explosive, trinitrobenzyl chloride, with sodium hydroxide in the presence of triethylbenzyl ammonium chloride. Commercial & Industrial note: For related, or similar information, see Application No. 966,674, December 5, 1978, by The United States Navy, to Isaac Angres, Gaithersburg, MD. Part or parts of this laboratory process may be protected by international, and/or commercial/industrial processes. Before using this process to legally manufacture the mentioned explosive, with intent to sell, consult any protected commercial or industrial processes related to, similar to, or additional to, the process discussed in this procedure. This process may be used to legally prepare the mentioned explosive for laboratory, educational, or research purposes.

Hazards: Wear gloves and use proper ventilation when carrying out this reaction.

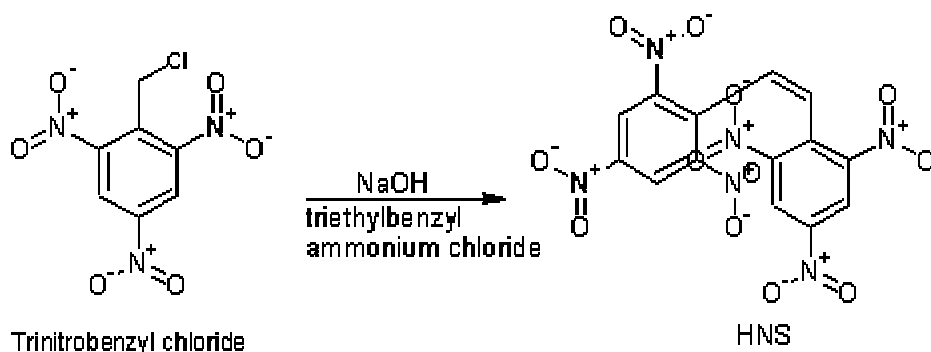

Reaction Equation

Procedure: Place 13.8 grams triethylbenzyl ammonium chloride, and 210 milliliters of methylene chloride into a 500-milliliter Erlenmeyer flask. Then begin stirring the mixture. After which, add 15.6 grams of trinitrobenzyl chloride while continuously stirring the reaction mixture. Afterwards, prepare a sodium hydroxide solution by dissolving 2.4 grams of sodium hydroxide into 10 milliliters of water, and then add this sodium hydroxide solution to the 500-milliliter Erlenmeyer flask with constant stirring (sodium hydroxide evolves great heat when dissolved in water so wait until the sodium hydroxide solution cools before adding it to the reaction mixture). After addition of the sodium hydroxide solution, stir the reaction mixture for 2 hours. After which, filter-off the precipitated product and then wash the product with four 50-milliliter portions of methanol several times each portion. Then dry the HNS in an oven at 100 Celsius. The HNS product will weigh about 10.8 grams.

Notes:

Procedure 12-02B: Preparation of HNS

Materials:	1. 10 grams TNT
	2. 600 milliliters of DMSO
	3. Dry oxygen gas (lecture bottle)
	4. 12.64 grams sodium benzoate
	5. 20 milliliters 10% hydrochloric acid
	6. 200 milliliters methanol

Summary: HNS is prepared by reacting TNT with sodium benzoate in the presence of DMSO (dimethylsulfoxide). The reaction is carried out in the presence of dry excess oxygen to ensure quality. After the reaction mixture has been stirred for some time, the mixture is treated with cold water to precipitate the crude HNS. The crude HNS is then washed with methanol and acetone to dissolve impurities. Commercial & Industrial Note: Part or parts of this laboratory process may be protected by international, and/or commercial/industrial processes. Before using this process to legally manufacture the mentioned explosive, with intent to sell, consult any protected commercial or industrial processes related to, similar to, or additional to, the process discussed in this procedure. This process may be used to legally prepare the mentioned explosive for laboratory, educational, or research purposes.

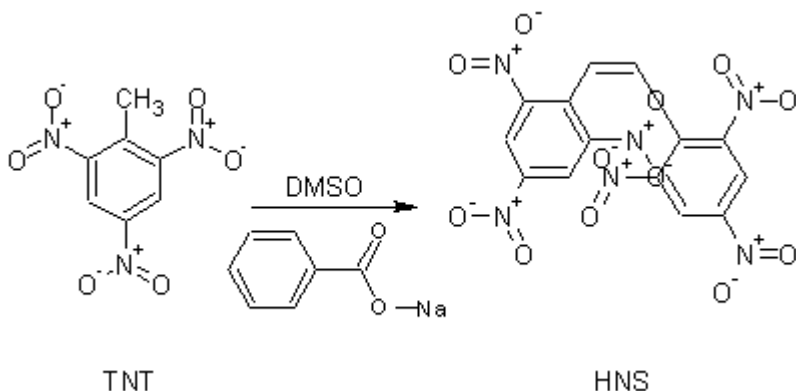

Reaction Equation

Hazards: Methanol, and acetone are highly flammable, extinguish all flames and do not smoke. Avoid inhalation of the vapors. Wear gloves when handling DMSO; can be absorbed by the skin.

Procedure: Dissolve 10 grams of TNT into 600 milliliters of DMSO, and then stir the mixture for 20 minutes; keep the flask sealed from air. During the 20-minute stirring period, pass dry oxygen into the flask just above the surface of the DMSO/TNT mixture. After 20 minutes, stop the oxygen flow, and open the flask to the air, and then add 12.64 grams of sodium benzoate in several large portions, and then seal the flask. After sealing the flask, pass dry oxygen into the flask just above the surface of the reaction mixture. Maintain the temperature of the reaction mixture at about room temperature (a water bath may or may not be needed), and continue the stirring of the reaction mixture, and continue the dry oxygen flow for 90 minutes. Note: after 90 minutes, the color of the reaction mixture will change from a purple color, to a red/brown color. Then add the entire reaction mixture into an acidic water solution prepared by dissolving 20 milliliters of 35% hydrochloric acid into 1980 milliliters of cold water, and allow the mixture to stand for about 1 hour. After 1 hour, filter-off the precipitated product, wash with 200 milliliters of cold water, 200 milliliters of methanol, 200 milliliters of acetone, and then vacuum dry or air-dry the product. The dry product will be high purity HNS. Note: The acetone-washing fraction can be evaporated to yield a small quantity of DPE (dipicryl ethane), and the methanol fraction can be evaporated to recover a small amount of unreacted TNT.

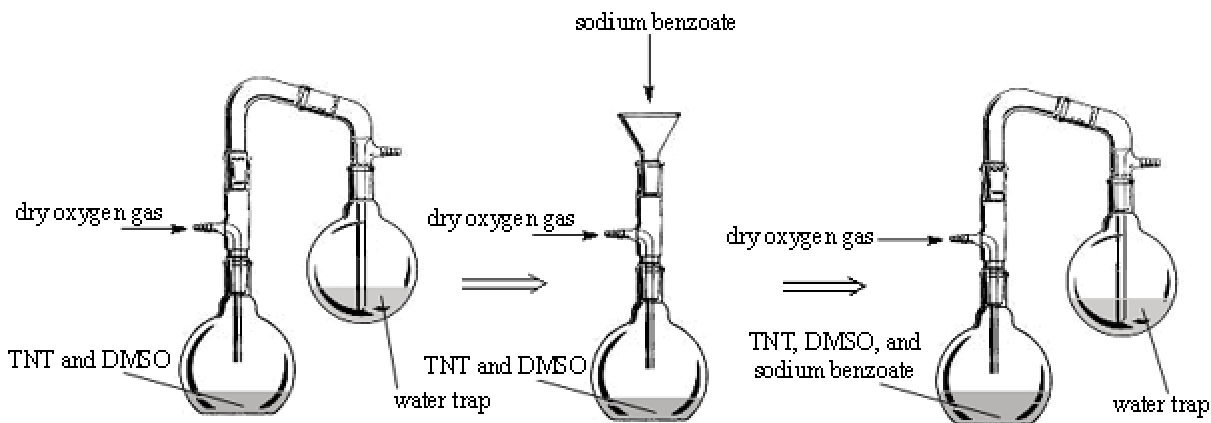
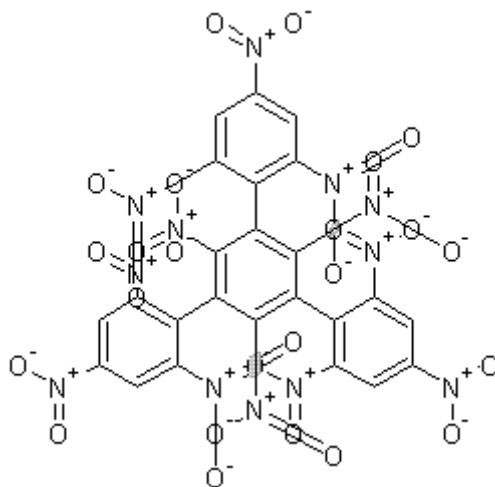

Figure 058. Oxygenating the flask during sodium benzoate addition.

Notes:

12-03. TNTPB. *1,3,5-trinitro-2,4,6-tripicrylbenzene*

TNTPB

Uses: TNTPB is a macro poly nitro explosive, which is used in thermally stable warheads, charges, and munitions. It can be used in high temperature resistant demolition charges for fighting oil well fires, for clearing tree lines, avalanche control, and for geological studies including seismic survey operations in volcanic or hot terrain environments. TNTPB is well suitable for use in missile warheads, artillery shells, and rockets. It can also be used in making plastic explosives and sheet explosives when alloyed with RDX, or HMX and then mixed with a suitable high-energy plasticizer.

Molecular weight: 846.371	Flammability: Burns with smoky flame
Detonating velocity: Similar to HNS also reported 8000	Toxicity: Moderate
Sensitivity: Very low	Classification: Secondary explosive
Stability: Very good	Overall value (as secondary explosive): Moderate

Procedure 12-03A: Preparation of TNTPB

Materials:	1. 200 grams copper powder
	2. 1000 milliliters 35 - 38% hydrochloric acid
	3. 1960 milliliters methanol
	4. 600 milliliters diethyl ether
	5. 1200 milliliters mesitylene
	6. 63.2 grams trichlorotrinitrobenzene
	7. 148.48 grams picrylchloride
	8. 40 grams diatomaceous earth
	9. 60 grams activated charcoal
	10. 540 milliliters of acetone

Summary: TNTPB is made by reacting the high explosives, picrylchloride and trichlorotrinitrobenzene, with mesitylene in the presence of activated copper. Commercial & Industrial note: For related, or similar information, see Application No. 237,610, August 25, 1988, by Jet Research Center, Inc., to Robert S. Riggs, Grand Prairie, TX. Part or parts of this laboratory process may be protected by international, and/or commercial/industrial processes. Before using this process to legally manufacture the mentioned explosive, with intent to sell, consult any protected commercial or industrial processes related to, similar to, or additional to, the process discussed in this procedure. This process may be used to legally prepare the mentioned explosive for laboratory, educational, or research purposes.

Hazards: Use proper ventilation and wear gloves when handling 35% hydrochloric acid. 35% Hydrochloric acid is highly fuming liquid with a choking odor. 35% Hydrochloric acid, and its vapors are highly corrosive. Handle with care.

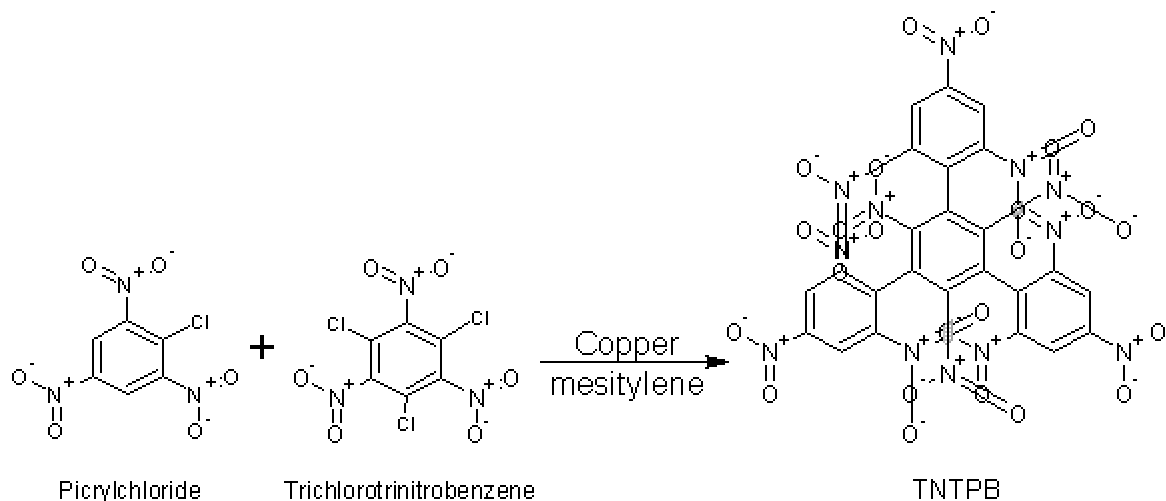

Reaction Equation

Procedure: First, 200 grams of copper powder has to be activated. To activate the copper powder, place it into 1000 milliliters of 35% hydrochloric acid and then heat the mixture to 50 Celsius, and stir the mixture rapidly for 1 hour. After which, filter-off the copper while the mixture is still hot, and then wash the activated copper three times with 600 milliliters of water, then one time with 600 milliliters of methanol, and then once with 600 milliliters of diethyl ether. Afterwards, vacuum dry or air-dry the activated copper. Then place 132 grams of this activated copper and 400 milliliters of mesitylene into a 2-liter 3-neck flask equipped with a condenser, dropping funnel, and thermometer. Then heat this mixture while stirring, to 160 Celsius. Then to the dropping funnel, add 800 milliliters of mesitylene, 63.2 grams of 1,3,5-trichloro-2,4,6-trinitrobenzene, and 148.48 grams of picrylchloride (shake the funnel to dissolve all solids). When the mixture in the 2-liter 3-neck flask reaches 160 Celsius, add approximately 40 milliliters of the contents from the dropping funnel, while stirring the mixture in the 2-liter 3-neck flask and keeping its temperature at 160 Celsius.

An induction period of 10 to 20 minutes is required before the reaction begins. The induction period is complete when the copper in the 2-liter 3-neck flask loses its sheen and becomes bronze colored and then chocolate colored (watch for these color changes closely). When the chocolate color appears, add the remainder of the contents in the dropping funnel over a period of 20 minutes while constantly stirring of the reaction mixture. After the addition of the contents in the dropping funnel, keep the reaction temperature at 160 Celsius for 20 minutes. After this 20 minutes, remove the heat source and allow the reaction mixture to cool to room temperature.

Filter the mixture to remove the inorganic by-products, and then place the filtered mixture into a steam distillation apparatus, and steam distill for several hours to remove the mesitylene solvent (more than two hours may be needed to completely remove the solvent). After most of the mesitylene has passed over into the receiver flask, remove the steam source and/or the heat source and then allow the remaining contents in the flask to cool to room temperature. After which, filter the mixture to collect the precipitated solids. Then, place the filtered-off solids into a reflux apparatus along with 1200 milliliters of methanol, and then reflux this mixture at 65 Celsius for a period of 30 minutes. After refluxing for 30 minutes, remove the heat source, and allow the mixture to cool to room temperature. After which, filter-off the insoluble solid product, wash with 100 milliliters of methanol, and then vacuum dry or air-dry the product. After drying, place the solid product into 300 milliliters of acetone, and then treat this solution with 60 grams of activated charcoal, 40 grams of diatomaceous earth, and then stir the mixture for 1 hour. After stirring for 1 hour, reflux the entire mixture at 50 Celsius for 30 minutes. After refluxing for 30 minutes, allow the mixture to cool, and then filter the suspension to remove the charcoal and the diatomaceous earth. After filtering, recrystallize the TNTPB from the acetone, and then wash the product with 200 milliliters of a mixed solvent (prepared by adding 140 milliliters of acetone to 60 milliliters of methanol). Then, vacuum dry or air-dry the product. The yield of TNTPB should be 39 grams.

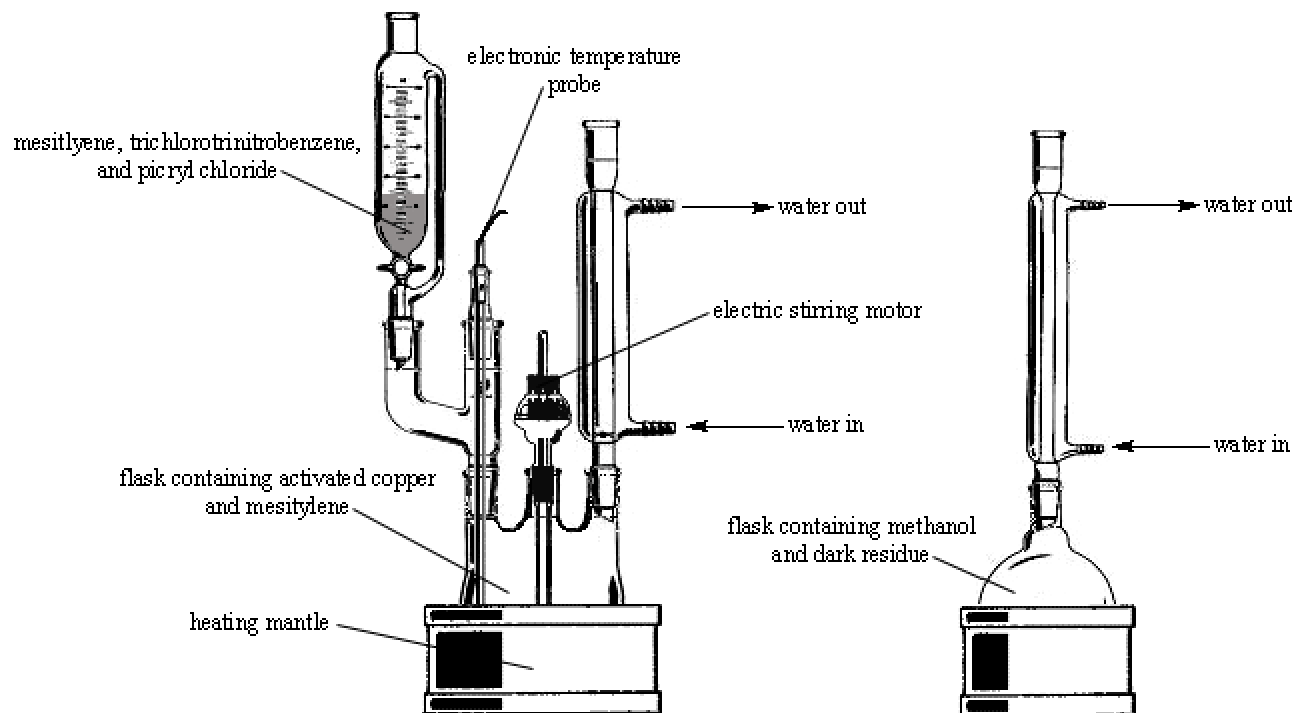
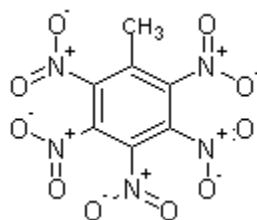

Figure 059. Apparatus for the preparation of TNTPB. Left illustration: Primary setup. Right illustration: Apparatus for refluxing methanol.

Notes:

12-04. PNT. 2,3,4,5,6-pentanitrotoluene



PNT

Uses: Can be used in priming compositions when mixed with lead styphnate or lead azide, explosives compositions with TNT, ammonium nitrate, RDX, HMX, or PETN, and in missile warheads in combination with HNS. PNT can also be used as a filler for rocket propellants as it increases thrust to weight ration.

Molecular weight: 317.126	Flammability: Burns with smoky flame but may flash
Detonating velocity: 7000 to 7400 (estimated)	Toxicity: Moderate
Sensitivity: Moderate	Classification: Secondary explosive
Stability: Very good	Overall value (as secondary explosive): Moderate

Procedure 12-04A: Preparation of PNT

Materials:	1. 60 grams TNT
	2. 1320 milliliters glacial acetic acid

CHAPTER 12: THE PREPARATION OF POLY NITRO BENZENES

3.	49.2 grams iron powder
4.	1000 milliliters 80% sulfuric acid
5.	25.6 grams 99% nitric acid
6.	1370 milliliters 98% sulfuric acid
7.	20 milliliters anisole
8.	7800 milliliters methylene chloride
9.	600 milliliters 30% fuming sulfuric acid
11.	300 grams anhydrous magnesium sulfate
12.	900 milliliters of chloroform

Summary: PNT is made in a five step process starting with the reduction of TNT to 2-amino-4,6-dinitrotoluene using iron powder. The resulting intermediate is then treated with sulfuric acid, and then nitrated. The 2-amino-N,3,4,5,6-pentanitrotoluene produced, is then converted into PNT by reaction with sulfuric acid, and fuming sulfuric acid. Commercial & Industrial note: For related, or similar information, see Application No. 456,672, January 10, 1983, by The United States Navy, to Ronald L. Atkins, Ridgecrest, CA, Richard A. Hollins, Ridgecrest, CA, William P. Norris, Ridgecrest, CA, Arnold T. Nielsen, Ridgecrest, CA, and William S. Wilson, Greensborough, AU. Part or parts of this laboratory process may be protected by international, and/or commercial/industrial processes. Before using this process to legally manufacture the mentioned explosive, with intent to sell, consult any protected commercial or industrial processes related to, similar to, or additional to, the process discussed in this procedure. This process may be used to legally prepare the mentioned explosive for laboratory, educational, or research purposes.

Hazards: Warning! Wear gloves and use proper ventilation when handling 99% nitric acid, and 30% fuming sulfuric acid. 99% Nitric acid is a highly toxic and corrosive liquid, which evolves poisonous fumes of nitrogen oxides. Use great care. 30% Fuming sulfuric acid is a highly corrosive and toxic liquid, which evolves toxic and choking fumes of sulfur trioxide. 30% Fuming sulfuric acid can cause severe skin burns so use great care. Wear gloves when handling corrosive acetic acid, and 98% sulfuric acid. Iron powder is highly flammable, so keep away from sparks and open flames.

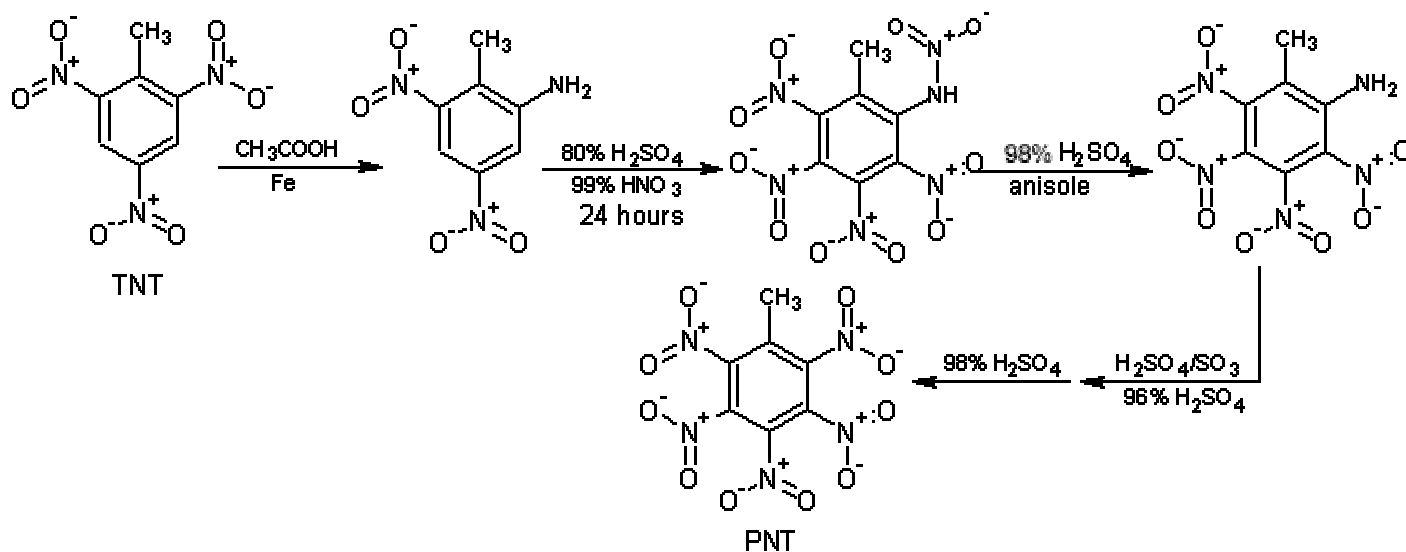

Reaction Equation

Procedure:

Step 1: Preparation of 2-amino-4,6-dinitrotoluene

Dissolve 60 grams of TNT into 1320 milliliters of glacial acetic acid while stirring the glacial acetic acid. After the TNT has dissolved, stir the mixture rapidly, and then slowly add 49.2 grams of iron powder (500 mesh) in small portions over a period of two hours. After two hours, add water to the reaction mixture until its total volume is 3000 milliliters. Afterwards, filter-off the bright yellow precipitated product, and then wash with 400 milliliters of water 3 times. Then vacuum dry or air-dry the product. The result will be 23 grams of 2-amino-4,6-dinitrotoluene.

Step 2: Preparation of 2-amino-3,4,5,6-tetranitrotoluene

Dissolve 20 grams of 2-amino-4,6-dinitrotoluene (prepared in step 1) into 1000 milliliters of 80% sulfuric acid at room temperature. Then slowly add 25.6 grams of 99% nitric acid, drop wise, while stirring the sulfuric acid mixture. After the addition, stir the reaction mixture for 24 hours at room temperature. After 24 hours, filter-off the yellow crystalline precipitate, and then air dry. Afterwards, add the dry filtered precipitate to 1000 milliliters of 98% sulfuric acid while stirring the 98% sulfuric acid, and then add 20 milliliters of anisole. Then stir the mixture for 1 hour at room temperature. After 1 hour, extract the mixture with ten 750-milliliter portions of methylene chloride. After extraction, combine the extraction portions (if not already done so), and then add 300 grams of anhydrous magnesium sulfate (to absorb water). Then stir the mixture for 20 minutes. After 20 minutes, filter-off the magnesium sulfate. After filtration, recover the methylene chloride by distillation at 40 Celsius until dry solid remains (the distillation may need to be temporarily stopped in order to filter-off precipitated product). After the distillation, remove the heat source and allow the contents in the distillation flask to cool to room temperature. After which, recover the dry product from the distillation flask. Then vacuum dry or air-dry any product that may have been filtered-off during the distillation process, and after drying, combine with the dry product collected from the distillation flask. Then recrystallize all the dry product from 300 milliliters of methylene chloride, and then wash with 400 milliliters of water. Thereafter, vacuum dry or air-dry the product. The yield will be 14 grams of dry 2-amino-3,4,5,6-tetranitrotoluene in the form of yellow crystals with a melting point of 183 Celsius.

Step 3: Preparation of pentanitrotoluene

Prepare an acid mixture by adding 30 milliliters of 98% sulfuric acid into 90 milliliters of 30% fuming sulfuric acid. Thereafter, add and dissolve 14 grams of 2-amino-3,4,5,6-tetranitrotoluene (prepared in step 2) while stirring the acid mixture. Then slowly add 7 milliliters of 98% sulfuric acid, drop wise, over a period of 40 minutes while stirring the reaction mixture. After the addition of the 98% sulfuric acid, stir the reaction mixture overnight at room temperature. Afterwards, extract the reaction mixture with six 150-milliliter portions of chloroform. The chloroform will be the upper layer. After the extraction process, combine all three portions of chloroform (if not already done so), and then remove the chloroform by distillation at 65 Celsius until dry solid remains (the distillation may need to be temporarily stopped in order to filter-off precipitated product). After the chloroform has been removed, remove the heat source and allow the contents in the distillation flask to cool to room temperature. Then collect the dry product from the distillation flask, and then vacuum dry or air-dry any product that may have been filtered-off during the distillation process. Then combine all the dry product, wash with 400 milliliters of water, and then vacuum dry or air-dry. The result will be 13 grams of pentanitrotoluene, as yellow crystals with a melting point of 224 Celsius.

Notes:

12-05. HNBP. *Hexanitrobiphenyl*

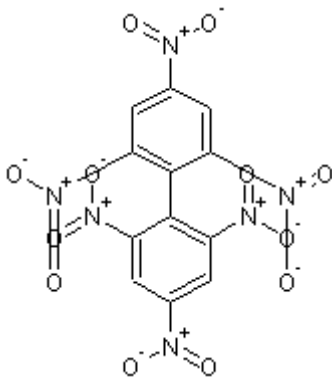

HNBP

Uses: Substitute for HNS or in combination with HNS for thermally stable charges, warheads, shells, and many types of munitions—has excellent resistance to shock, percussion, heat, and friction.

Molecular weight: 424.193	Flammability: Burns with smoky flame
Detonating velocity: Similar to HNS	Toxicity: Moderate
Sensitivity: Very low	Classification: Secondary explosive

Stability: Very good

Overall value (as secondary explosive): Moderate

Procedure 12-05A: Preparation of HNBP

Materials:	1. 20 grams picryl chloride
	2. 400 milliliters ethylene dichloride
	3. 8.8 grams copper powder
	4. 100 milliliters acetone

Summary: HNBP is prepared by reacting picryl chloride with copper powder. The resulting product is then precipitated, filtered, washed, and then dried. The crude product is then recrystallized from acetone to yield pure HNBP. **Commercial & Industrial Note:** Part or parts of this laboratory process may be protected by international, and/or commercial/industrial processes. Before using this process to legally manufacture the mentioned explosive, with intent to sell, consult any protected commercial or industrial processes related to, similar to, or additional to, the process discussed in this procedure. This process may be used to legally prepare the mentioned explosive for laboratory, educational, or research purposes.

Hazards: Use proper ventilation when handling acetone. Acetone is a highly flammable and volatile liquid, so do not smoke and extinguish any open flames.

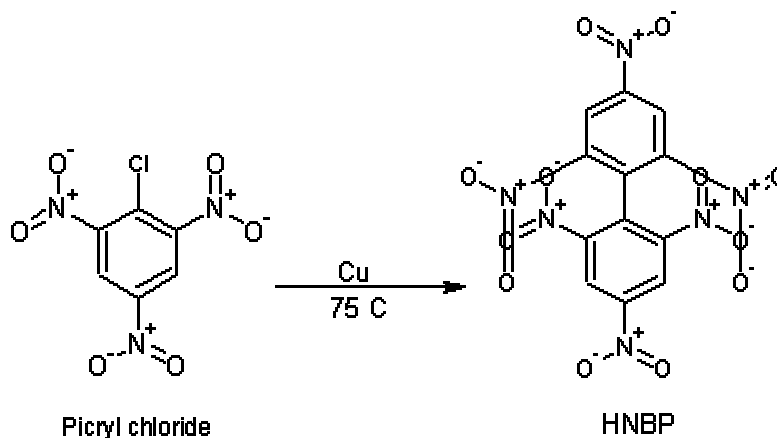
*Reaction Equation*

Procedure: Add 20 grams of picryl chloride and 400 milliliters of ethylene dichloride to a 1-liter flask equipped with a stirrer, thermometer, and condenser. Then stir the mixture to fully dissolve the picryl chloride. Afterwards, heat the mixture to 75 Celsius. When the temperature of the mixture reaches 75 Celsius, slowly add in small portions, 8.8 grams of copper powder while rapidly stirring the picryl chloride mixture. After the addition of the copper powder, reflux the reaction mixture at 84 Celsius for two hours. After which, remove the heat source, and allow the mixture to cool to room temperature. Then filter-off the precipitated product, wash with 400 milliliters of water, and then vacuum dry or air-dry the product. Then recrystallize the product from 100 milliliters of acetone, and then wash with 400 milliliters of water. Then vacuum dry or air-dry the product.

Notes:

12-06. Hexaditon. 2,2',4,4',6,6'-hexanitrodiphenylmethane

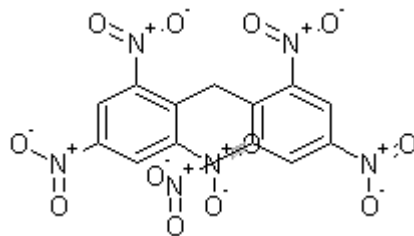

Hexaditon

Hexaditon (also called hexaditan) forms fine, pale yellow, to almost colorless needles with a melting point of 230 Celsius. It is soluble in acetone, acetonitrile, dimethylsulfoxide, and tetrahydrofuran. It is insoluble in alcohol, chloroform, and ether. Hexaditon can be used as a substitute for HNS, or in combination with HNS for use in thermally stable charges, warheads, shells, and many types of munitions. Hexaditon can also be alloyed with many other secondary explosives forming thermally, heat, shock, percussion, and friction resistant charges.

Molecular weight: 438.220	Flammability: Burns with smoky flame
Detonating velocity: Similar to HNS	Toxicity: Moderate
Sensitivity: Very low	Classification: Secondary explosive
Stability: Very good	Overall value (as secondary explosive): High

Procedure 12-06A: Preparation of Hexaditon

Materials:	1. 9 grams TNT
	2. 100 milliliters of tetrahydrofuran (THF)
	3. 20 milliliters 11.2% potassium hydroxide/methanol solution
	4. 5 grams picryl chloride
	5. 50 milliliters dimethylsulfoxide (DMSO)
	6. 50 milliliters 35 - 38% hydrochloric acid
	7. 350 milliliters methanol
	8. 70 milliliters acetonitrile

Summary: Hexaditan is prepared by first, reacting TNT with a methanol solution containing 11.2% potassium hydroxide by weight. The resulting intermediate is then treated with a picryl chloride solution, and with a dilute hydrochloric acid solution. The precipitated product is filtered, washed, and then dissolved into acetonitrile. The acetonitrile solution is then treated with hot methanol to precipitate the product. The product is washed, and then dried. Commercial & Industrial note: For related, or similar information, see Application No. 871,220, June 25, 1969, by The United States Navy, to Kathryn G. Shipp, Silver Spring, MD, Lloyd A. Kaplan, Silver Spring, MD. Part or parts of this laboratory process may be protected by international, and/or commercial/industrial processes. Before using this process to legally manufacture the mentioned explosive, with intent to sell, consult any protected commercial or industrial processes related to, similar to, or additional to, the process discussed in this procedure. This process may be used to legally prepare the mentioned explosive for laboratory, educational, or research purposes.

Hazards: Use proper ventilation and extinguish any open flames when handling tetrahydrofuran, which is a highly volatile and flammable liquid. Wear gloves and use proper ventilation when handling DMSO. DMSO can be absorbed through the skin causing potential tissue irritation. Wear gloves and use proper ventilation when handling 35 – 38% hydrochloric acid, which is a highly toxic and corrosive liquid evolving choking and corrosive fumes.

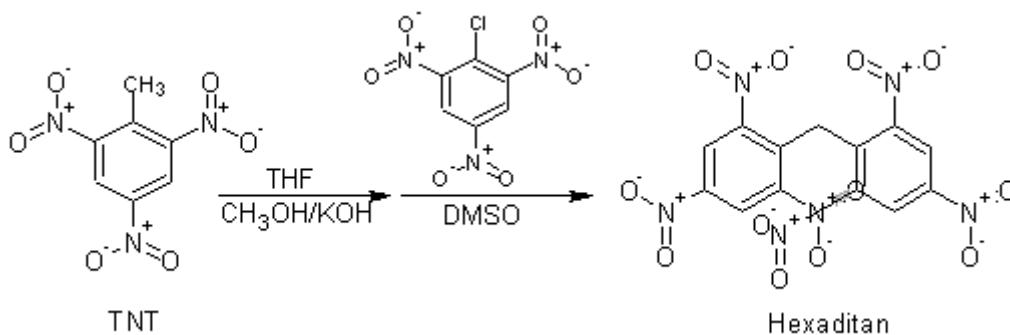

Reaction Equation

Procedure: Prepare a solution (solution A) by adding 9 grams of TNT into 100 milliliters of THF at room temperature. Prepare a second solution (solution B) by adding 5 grams of picryl chloride into 50 milliliters of DMSO at room temperature. Prepare a third solution (solution C) by adding 50 milliliters of 35 – 38% hydrochloric acid into 1500 milliliters of water at room temperature. Now rapidly add solution A to 20 milliliters of a 11.2% potassium hydroxide in methanol solution while rapidly stirring the potassium hydroxide solution. Upon addition, there is an immediate formation of a dark reddish-brown solid. Then immediately after the addition of solution A, rapidly add solution B while stirring the reaction mixture. Upon addition, a deep blue color rapidly develops, and then darkens almost to a black color. After the addition of solution B, stir the reaction mixture for 1 hour. Afterwards, rapidly add solution C while stirring the reaction mixture. An orange-yellow precipitate forms which gradually precipitates. After the addition of solution C, place the reaction mixture into a cold-water bath, and stir the reaction mixture for 1 hour. After which, filter-off the precipitated product, wash with 400 milliliters of cold water, and then vacuum dry or air-dry. Then mix the dry precipitated product with 150 milliliters of methanol, and blend the mixture for 2 minutes. Then filter-off the insoluble product, and then mix the filtered-off product with the same 150 milliliter portion of methanol. Thereafter, blend for 2 minutes followed by re-filtering to obtain the insoluble product. Then wash the filtered-off product with 100 milliliters of methanol, and then dry the product in an oven at 80 Celsius for 1 hour or until dry. Afterwards, dissolve the dry product into 70 milliliters of acetonitrile. Then filter the mixture to remove insoluble impurities. Now, place 100 milliliters of methanol into a flask, and heat to 40 Celsius. Then add this hot methanol to the filtered acetonitrile mixture (the product will precipitate). Afterwards, cool the mixture to room temperature, and then filter-off the precipitated product. Then wash the product with 400 milliliters of cold-water, and then vacuum dry, air-dry, or dry the product in an oven at 80 Celsius until dry.

Notes:

12-07. TNN. Nitronaphthalene; 1,3,6,8-tetranitronaphthalene

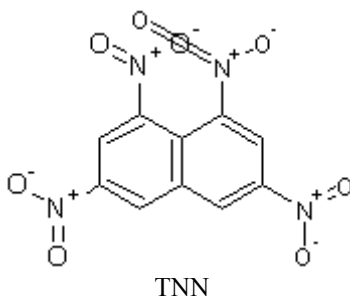

TNN is actually a mixture of the above compound (1,3,6,7-tetranitronaphthalene—70%) but also 1,4,5,8-tetranitronaphthalene (25%), and 1,2,5,6-tetranitronaphthalene (5%).

CHAPTER 12: THE PREPARATION OF POLY NITRO BENZENES

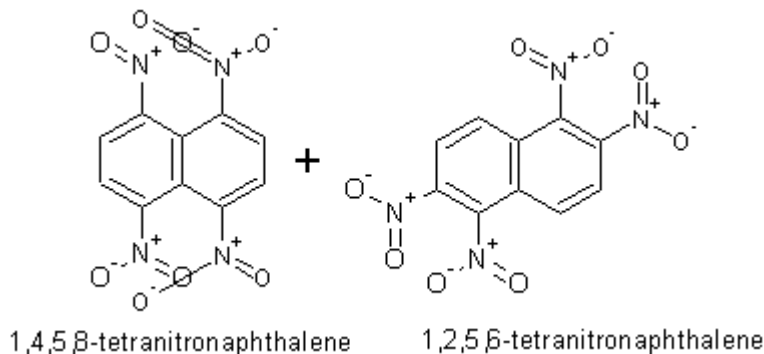

TNN, which is actually a mixture of 3 isomers (as described above), is a yellowish to light yellowish solid with a melting point ranging from 190 to 215 Celsius (depending on purity). The solid is very stable, and can be melted and alloyed with many other secondary explosives to form thermally stable explosives compositions with a high resistance to shock, friction, heat, and percussion. TNN is freely soluble in chloroform, ether, and carbon disulfide, and is moderately soluble in alcohol, but insoluble in water. TNN is not used in military explosives to an amount that would warrant extreme importance for its existence; however, TNN is rather inexpensive to make, and is readily available during times of war. It can be used for filling shells, bombs, and warheads, and has satisfactory power.

Molecular weight: 308.161	Flammability: Burns with smoky flame
Detonating velocity: Slightly above TNT—7050	Toxicity: Moderate
Sensitivity: Very low	Classification: Secondary explosive
Stability: Very good	Overall value (as secondary explosive): Moderate

Procedure 12-07A: Preparation of TNN

Materials:	1. 185 milliliters of 70% nitric acid
	2. 1750 milliliters of 98% sulfuric acid
	3. 450 grams of naphthalene
	4. 650 grams of 98% sulfuric acid
	5. 340 grams of potassium nitrate or 286 grams of sodium nitrate
	6. 1600 milliliters of 99% nitric acid
	7. 1500 milliliters of a 5% sodium carbonate solution
	8. 500 milliliters of 95% ethyl alcohol
	9. 1500 milliliters of chloroform

Summary: TNN is prepared in a three-step process starting with the formation of the mono isomers of naphthalene. These mono isomers are easily prepared by nitrating naphthalene with 70% nitric acid in the presence of sulfuric acid. The resulting mono isomers are then collected by drowning the reaction mixture into cold water. After these mono isomers have been collected and dried, they are converted into the di and tri nitro isomers by nitration utilizing potassium or sodium nitrate in the presence of excess sulfuric acid. The resulting di and tri nitro isomers are then readily collected by treatment of the reaction mixture with cold water, followed by filtration, washing, and then drying. The final step involves the nitration of the dry di and tri nitro isomers with 99% nitric acid in the presence of concentrated sulfuric acid as usual. The reaction is quite simple, and once completed, the TNN and other tetra nitro isomers are collected by drowning the reaction mixture into cold water, followed by filtration, washing, and drying. The resulting dried TNN product is then recrystallized from a ethyl alcohol/chloroform solvent mixture.

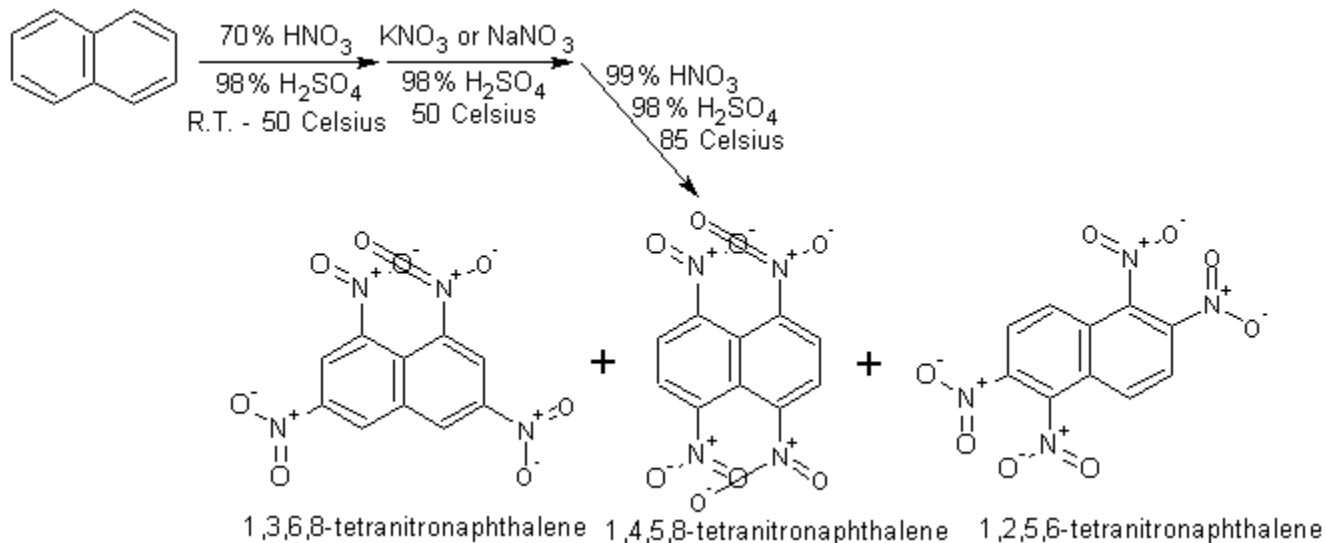
*Reaction Equation*

Hazards: Use caution when handling 70% nitric acid, which is very corrosive, and stains the skin yellow. Use great care and caution when handling 99% nitric acid, which is highly corrosive, and evolves toxic fumes of nitrogen oxides—use maximum ventilation at all times. Use care when handling 98% sulfuric acid, which is very corrosive and chars many different substances. Extinguish all flames before using 95% ethyl alcohol, which is flammable.

Procedure:**Step 1: Preparation of mono nitro isomers of naphthalene**

Into a suitable flask equipped with motorized stirrer, thermometer and powder funnel, add 185 milliliters of 70% nitric acid, followed by carefully adding 350 milliliters of 98% sulfuric acid. Thereafter, place this flask into a water bath at room temperature, and then slowly add in small portions, 450 grams of dry powdered naphthalene over a period of 6 hours while rapidly stirring the acid mixture and maintaining its temperature below 30 Celsius. After the addition of the naphthalene, remove the powder funnel and replace it with a condenser and then reflux the entire reaction mixture for 2 hours at 60 Celsius with constant stirring. After refluxing for 2 hours, remove the heat source, and allow the reaction mixture to cool to room temperature. Thereafter, drown the entire reaction mixture into 1000 milliliters of ice water, and then filter-off the precipitated crystals. Then wash these crystals with three 250-milliliter portions of cold water, and then vacuum dry or air-dry the crystals. The dry solid product will be a mixture of para, ortho, and meta isomers.

Step 2: Preparation of di and tri nitro isomers of naphthalene

Into a suitable clean flask equipped with motorized stirrer, thermometer and powder funnel, place 100 milliliters of ice cold water, and then slowly and carefully add in 650 grams of 98% sulfuric acid over a period of about 2 hours, and then allow the entire mixture to stand until it has cooled to room temperature (adding sulfuric acid to water evolves great heat, so perform with caution). When the acid mixture has cooled to room temperature, add in the dry solid product obtained in step 1. Then heat this mixture to 50 Celsius. When the temperature of the mixture reaches 50 Celsius, gently add in, in small portions, 340 grams of potassium nitrate or 286 grams of sodium nitrate over a period of 3 hours while rapidly stirring the reaction mixture and maintaining its temperature below 55 Celsius. After the addition of the potassium or sodium nitrate, continue to heat the reaction mixture at 50 Celsius for 1 additional hour with constant stirring. Thereafter, remove the heat source, and allow the reaction mixture to cool to room temperature. Then drown the entire reaction mixture into 1500 milliliters of ice-cold water, and then stir this mixture using a magnetic stirrer or other stirring means, for 12 hours. After 12 hours, filter-off the precipitated product, wash with three 500-milliliter portions of ice cold water, and then vacuum dry or air-dry the solid product.

Step 3: Preparation of TNN

Note: This procedure uses an excessive amount of 99% nitric acid to properly carryout the reaction. This excessive amount of acid can be recovered by treating the reaction mixture (after complete removal of the product) with methylene chloride to recover the nitric acid. Prior to this action, a small amount of sulfuric acid should be added to the reaction mixture. Afterwards,

CHAPTER 12: THE PREPARATION OF POLY NITRO BENZENES

the reaction mixture should be extracted with several volumes of methylene chloride. These combined volumes can then be carefully distilled to recover the nitric acid of 99% purity (see nitric acid, 90% and 99% respectively).

Into a suitable flask equipped with motorized stirrer, thermometer, and powder funnel, place 1600 milliliters of 99% nitric acid, and then carefully add 1400 milliliters of 98% sulfuric acid. Then place this acid mixture into a cold-water bath and chill to 10 Celsius. Thereafter, slowly add in small portions, the dry solid product obtained in step 2 over a period of 2 hours while rapidly stirring the acid mixture and maintaining its temperature below 15 Celsius. After the addition of the dry solid product obtained in step 2, replace the powder funnel with a condenser, and then reflux the reaction mixture at 85 Celsius for 4 hours while rapidly stirring. After refluxing for 4 hours, remove the heat source, and allow the reaction mixture to cool to room temperature. Afterwards, drown the entire reaction mixture into 3000 milliliters of ice water, and then allow this mixture to stand for several hours. Then filter-off the precipitated product, wash with three 500 milliliter portions of a 5% sodium bicarbonate solution, followed by three 500 milliliters portions of ice cold water, and then vacuum dry or air dry the product. Then dissolve this dry product into 2000 milliliters of a solvent mixture prepared by adding 500 milliliters of 95% ethyl alcohol to 1500 milliliters of chloroform. Then recrystallize the dissolved product from this solvent mixture, and after the recrystallization process, vacuum dry or air-dry the solid product.

Notes:

CHAPTER 13: THE PREPERATION OF NITRATE ESTERS

EDT, NITROCELLULOSE, ETN, PEN, PETN, NQ, NITRO STARCH, EGDN, METRIOL, NITROPROPYLENE

13-01. EDT. *N,N'*-di-(2-ethanol)ethylenediamine tetranitrate

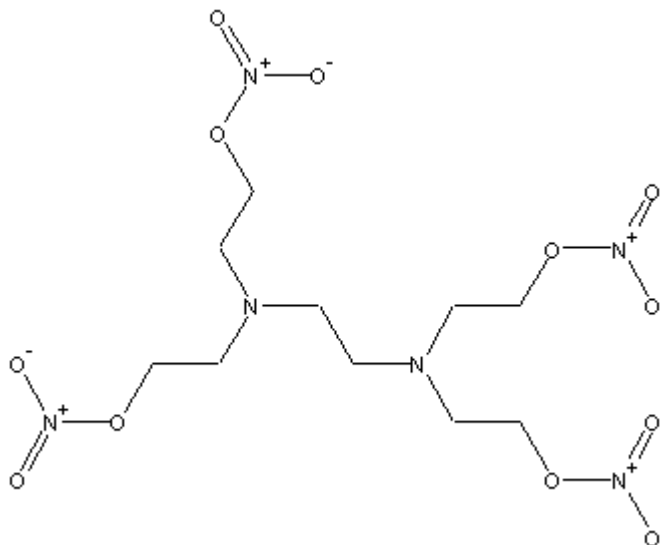

EDT

EDT forms white crystals with a melting point of 170 Celsius (with decomposition beginning). EDT has similar properties as other nitrate esters, and can be used as such in nitroglycerine free dynamites, high performance gun propellants, rocket propellants, and explosives compositions.

Molecular weight: 416.3	Flammability: May flash when strongly ignited
Detonating velocity: Similar to PETN	Toxicity: Moderate
Sensitivity: Low	Classification: Secondary explosive
Stability: Very good	Overall value (as secondary explosive): Moderate

Procedure 13-01A: Preparation of EDT

Materials:	1. 500 milliliters 99% nitric acid
	2. 98.6 grams <i>N,N'</i> -diethanoethylenediamine
	3. 2000 milliliters 95% ethanol

Summary: EDT is easily prepared by the reaction of *N,N'*-diethanoethylenediamine with 99% nitric acid. After the reaction, the mixture is poured onto ice, and the crude product is thus obtained by the addition of 95% ethanol. The precipitated product is then filtered-off, washed, and dried. Purification is accomplished by recrystallization from a dilute ethanol water solution. Commercial & Industrial note: For related, or similar information, see Serial No. 570,805, December 30th, 1944, by The United States Navy, to Alfred T. Bloomquist, and Fred T. Fiedorek, both of Ithaca, NY. Part or parts of this laboratory process may be protected by international, and/or commercial/industrial processes. Before using this process to legally manufacture the mentioned explosive, with intent to sell, consult any protected commercial or industrial processes related to, similar to, or additional to, the process discussed in this procedure. This process may be used to legally prepare the mentioned explosive for laboratory, educational, or research purposes.

CHAPTER 13: THE PREPERATION OF NITRATE ESTERS

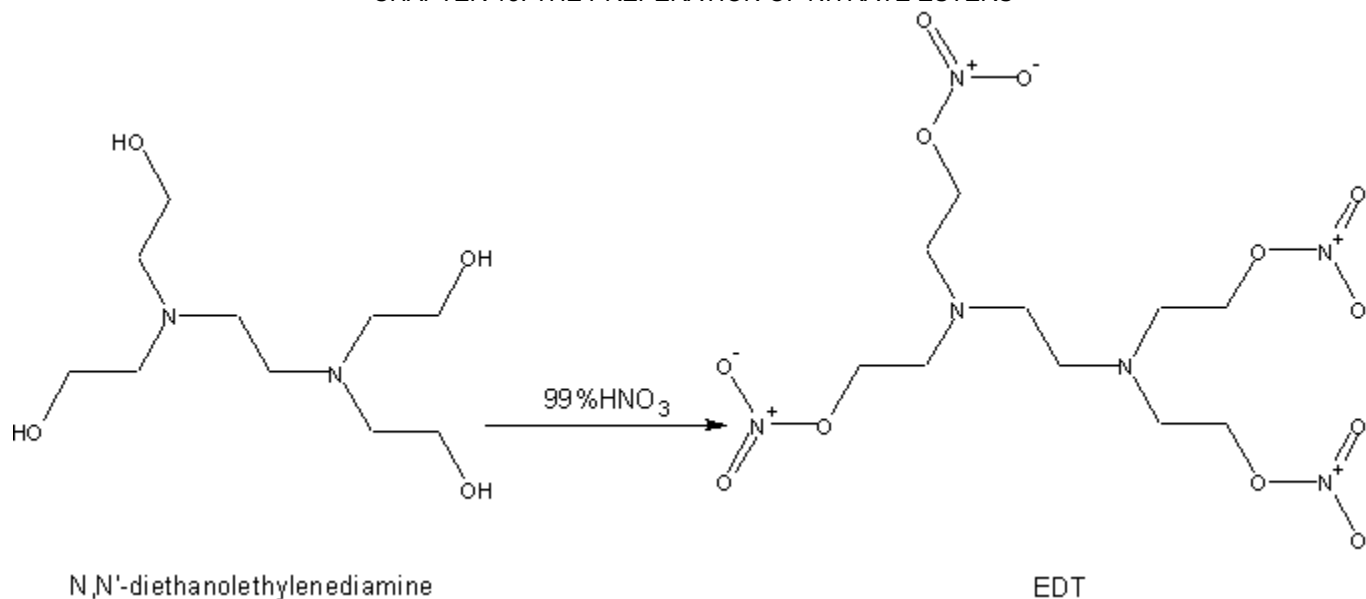

Reaction Equation

Hazards: Wear gloves and use proper ventilation when handling 99% nitric acid. Use great care, and avoid inhalation of the vapors. 99% nitric acid is highly corrosive and evolves poisonous fumes of nitrogen oxides. Extinguish all flames before using 95% ethanol, and avoid inhalation of vapors.

Procedure: Note: This procedure uses an excessive amount of 99% nitric acid to properly carryout the reaction. This excessive amount of acid can be recovered by treating the reaction mixture (after complete removal of the product) with methylene chloride to recover the nitric acid. Prior to this action, a small amount of sulfuric acid should be added to the reaction mixture. Afterwards, the reaction mixture should be extracted with several volumes of methylene chloride. These combined volumes can then be carefully distilled to recover the nitric acid of 99% purity (see nitric acid, 90% and 99% respectively).

Into a 2000-milliliter flask equipped with a thermometer and motorized stirrer, add 500 milliliters of 99% nitric acid. Then chill this nitric acid to 10 Celsius by means of an ice bath. Thereafter, gradually add 98.6 grams of N,N'-diethanolethylenediamine over a sufficient period as to maintain the nitric acid at a temperature below 15 Celsius. During the addition, rapidly stir the nitric acid. After the addition, heat the reaction mixture to about 35 Celsius with stirring. Then, heat at 35 Celsius for 30 minutes with stirring. Thereafter, pour the entire reaction over 1500 grams of crushed ice. After much of the ice has melted, pour in 1000 milliliters of 95% ethanol while stirring the ice mixture. Thereafter, filter-off the precipitated product, and then wash with four 100-milliliter portions of 95% ethanol, using the same two washing portions several times, and then vacuum dry or air-dry the product. Then recrystallize the product from a solvent mixture prepared by dissolving 200 grams of 95% ethanol into 800 grams of water, and then wash the collected crystals with four 100-milliliter portions of 95% ethanol, and then vacuum dry or air dry the product. Note: the ratio of water to the ethanol may have to be adjusted to facilitate proper dissolving of the crude product; depending on the purity of the crude product. The result will be about 162 grams of the product.

Notes:

Procedure 13-01B: Preparation of EDT

Materials:	1. 100 grams ethylenediamine
	2. 294 grams ethylene oxide
	3. 40 grams phosphorus pentoxide
	4. 2758 grams of 99% nitric acid
	5. 10% ammonia solution
	6. 1800 milliliters diethyl ether

CHAPTER 13: THE PREPERATION OF NITRATE ESTERS

Summary: N-Tetranitrate can be prepared first, by preparing an intermediate, tetra-N,N,N,N-(2-hydroxyethyl)ethylenediamine, by reacting ethylenediamine with ethylene oxide. The intermediate is then collected by evaporation of the water, and then treated with 99% nitric acid. After the reaction, the reaction mixture is extracted with diethyl ether. The diethyl ether is then removed by evaporation to yield the product. Commercial & Industrial note: For related, or similar information, see Serial No. 787,834, October 18th, 1960, by The Chattanooga Medicine Company, to John C. Krantz, Jr., Ruxton, MD, Raymond M. Burgison, Catonsville, MD. Part or parts of this laboratory process may be protected by international, and/or commercial/industrial processes. Before using this process to legally manufacture the mentioned explosive, with intent to sell, consult any protected commercial or industrial processes related to, similar to, or additional to, the process discussed in this procedure. This process may be used to legally prepare the mentioned explosive for laboratory, educational, or research purposes.

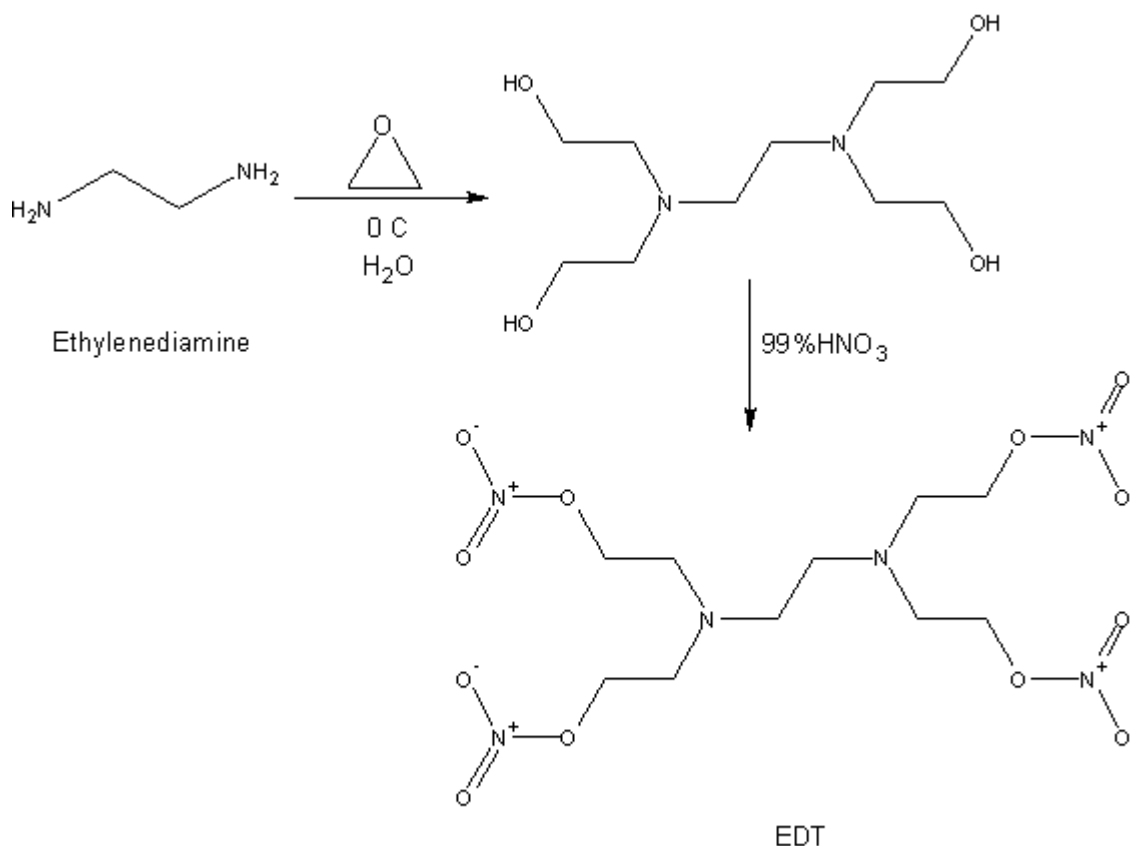

Reaction Equation

Hazards: Use great care when handling 99% nitric acid. 99% nitric acid is highly volatile, and evolves highly poisonous fumes of nitrogen oxides. Wear gloves, proper lab clothing, and use maximum ventilation. Diethyl ether is highly flammable, and forms explosive peroxides with air. Perform the peroxide test before using. Avoid inhalation of diethyl ether vapors.

Procedure:

Step 1: Preparation of tetra-N,N,N,N-(2-hydroxyethyl)ethylenediamine

Into a suitable flask, add 300 milliliters of water, and then 100 grams of ethylenediamine. Then place this mixture into an ice bath and cool to 0 Celsius. When the temperature reaches 0 Celsius, slowly add 294 grams of ethylene oxide at a rate sufficient to maintain the reaction mixtures temperature at 0 Celsius. During the addition of the ethylene oxide, rapidly stir the reaction mixture. After the addition of the ethylene oxide, remove the ice bath, and allow the reaction mixture to warm to room temperature. Thereafter, place the reaction mixture into a rotary evaporator, and evaporate-off the water under high vacuum (do not use heat; over 30 Celsius decomposition of the product will result). Note: if a rotary evaporator is not available, place the reaction mixture into a shallow pan, and then blow air over it; this process could take days. When most of the water has been removed, remove the viscous liquid from the rotary evaporator, and place into a shallow pan. If using a shallow pan, once the

CHAPTER 13: THE PREPERATION OF NITRATE ESTERS

water has evaporated, place the remaining viscous liquid into a clean shallow pan. Then sprinkle about 40 grams of phosphorus pentoxide over the viscous liquid, and then place an airtight lid onto the shallow pan. Allow the product to stand in this way for 24 hours. After which, filter-off any insoluble materials, and then keep the filtered viscous liquid for step 2.

Step 2: Preparation of EDT

Note: This procedure uses an excessive amount of 99% nitric acid to properly carryout the reaction. This excessive amount of acid can be recovered by treating the reaction mixture (after complete removal of the product) with methylene chloride to recover the nitric acid. Prior to this action, a small amount of sulfuric acid should be added to the reaction mixture. Afterwards, the reaction mixture should be extracted with several volumes of methylene chloride. These combined volumes can then be carefully distilled to recover the nitric acid of 99% purity (see nitric acid, 90% and 99% respectively).

Into a suitable flask, add 2758 milliliters of 99% nitric acid, and then chill this acid to -10 Celsius by means of an ice/salt bath. Then slowly add the viscous product obtained in step 1, at a rate sufficient to keep the reaction temperature below 0 Celsius. During the addition, rapidly stir the nitric acid. After the addition, continue stirring rapidly and keep the reaction mixture cooled to 0 Celsius for 1 hour. After 1 hour, place 20 kilograms of ice into a large glass or plastic container, and then add the reaction mixture Note: a blue solution will result. After which, before the ice melts, slowly add a 10% ammonia water solution until a white gum, or thick oil separates. When a white gum, or thick oil separates, stop the addition of the ammonia solution, and then allow all of the ice to melt. Then, before the mixture begins to warm, extract the entire mixture with six 300-milliliter portions of diethyl ether (note: because of the large volume of ice added, the extraction should be carried in the following manner: Instead of using a seperatory funnel, simply mix each diethyl ether portion with the entire reaction mixture, then rapidly blend for ten minutes, then after blending, allow the mixture to settle for a few minutes, and then carefully decant the upper diethyl ether layer, each time. After the extraction process, combine all diethyl ether portions (if not already done so), and then add 100 grams of anhydrous sodium sulfate to absorb moisture. After which, filter-off the sodium sulfate, and then place the diethyl ether mixture into a rotary evaporator and evaporate under reduced pressure. When all the ether has been removed, stop the evaporation process, and then remove the product. Then place the product onto a vacuum filter, and vacuum dry for several hours.

Notes:

13-02. Nitrocellulose. *Nitrated cellulose; Gun cotton; cellulose trinitrate*

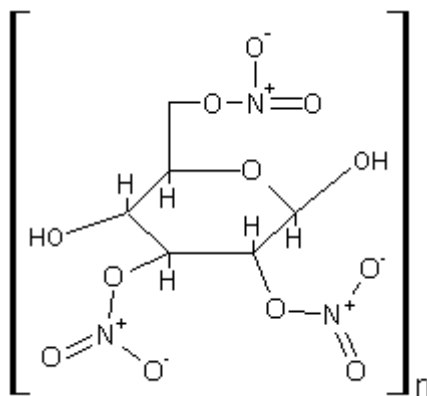

Nitrocellulose

Nitrocellulose forms a pulpy, cotton-like mass, white granules, flakes, or powder with a nitrogen content of 10 to 14%. Explosives grade nitrocellulose usually contains 12 to 14% nitrogen, and propellant grade nitrocellulose can contain 11 to 14% nitrogen content. It is soluble in acetone, but insoluble in water. Nitrocellulose is highly flammable, and even wetted nitrocellulose can burn. It is an excellent propellant, and is used extensively in military smokeless gunpowders—especially

CHAPTER 13: THE PREPERATION OF NITRATE ESTERS

when mixed with nitroglycerine. Nitrocellulose is widely used in rocket propellants, gun propellants, and blasting compositions—the later when mixed with ammonium nitrate, sodium nitrate, or saltpeter. Nitrocellulose is available in many different forms with varying nitrogen contents, and can be made by nitrating wood, wood pulp, cotton, cellulosic waste, newspaper, and may different cellulose containing entities—numerous modifications and processes for its preparation exist. Pure nitrocellulose should be stored wetted with 10% water or alcohol for prolonged storage.

Molecular weight: Not calculated (as high as 100,000)	Flammability: Highly flammable (deflagrates)
Detonating velocity: 7300	Toxicity: Low
Sensitivity: Easily ignited	Classification: Secondary explosive
Stability: Very good	Overall value (as secondary explosive): Extremely high

Procedure 13-02A: Preparation of high nitrogen content (13 to 14%) Nitrocellulose

Materials:	1. 608 grams of phosphorus pentoxide
	2. 3000 milliliters of methylene chloride
	3. 920 grams of 99% nitric acid
	4. 324 grams of cotton balls
	5. 600 milliliters 10% baking soda solution

Summary: High nitrogen nitrocellulose is prepared by reacting cotton balls with nitrogen pentoxide. The latter being made by dehydrating 99% nitric acid with phosphorus pentoxide. The nitrogen pentoxide reacts directly with the cellulose in the cotton linters forming nitrocellulose. After the reaction, the reaction mixture is poured into 1500 milliliters of cold-water. The nitrocellulose product is then collected by filtration. After filtration, the product is washed, and then vacuum dried or air-dried. Note: Numerous modifications to this procedure exist. Commercial & Industrial Note: Part or parts of this laboratory process may be protected by international, and/or commercial/industrial processes. Before using this process to legally manufacture the mentioned explosive, with intent to sell, consult any protected commercial or industrial processes related to, similar to, or additional to, the process discussed in this procedure. This process may be used to legally prepare the mentioned explosive for laboratory, educational, or research purposes.

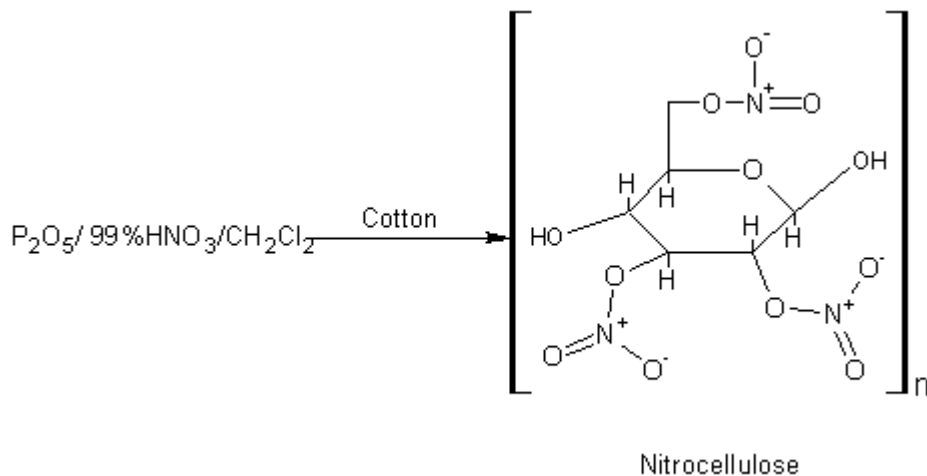

Reaction Equation

Hazards: Warning! Wear gloves and use proper ventilation when handling 99% nitric acid. 99% Nitric acid is a highly poisonous and corrosive liquid, which evolves highly poisonous fumes of nitrogen oxides. Use great care. Do not handle phosphorus pentoxide with bare hands because it can absorb moisture forming phosphoric acid, which causes skin burns. Caution! Nitrocellulose is a highly flammable solid.

Procedure: Place 608 grams of phosphorus pentoxide into a suitable flask, and then add 2000 milliliters of methylene chloride. Then add 920 grams of 99% nitric acid. After which, cool this mixture to -5 Celsius by the means of a salt/ice bath. Now, place 1000 milliliters of methylene chloride into a suitable beaker, and then add 324 grams of cotton balls. Then vigorously stir the mixture for 1 hour and then cool the mixture to -5 Celsius by means of a salt/ice bath. Afterwards, at a moderately fast rate, add the cooled methylene chloride/cotton balls mixture to the 99% nitric acid mixture while stirring the 99% nitric acid mixture. During the addition, the reaction temperature will increase to about 25 – 30 Celsius. After the addition, stir the reaction mixture for 1 hour and maintain the temperature below 30 Celsius. After 1 hour, pour the entire reaction mixture into 3000 milliliters of ice-cold water, and stir the ice-cold water for 1 hour. After which, filter-off the insoluble nitrocellulose mass, wash with four

CHAPTER 13: THE PREPERATION OF NITRATE ESTERS

500-milliliter portions of ice cold water, four 150 milliliter portions of 10% baking soda solution, and then four 500 milliliter portions of cold water. Thereafter, vacuum dry or air-dry the nitrocellulose.

Notes:

Procedure 13-02B: Preparation of high nitrogen content (13%) Nitrocellulose

Materials:	1. 314 grams 99% nitric acid
	2. 62 grams 98% sulfuric acid
	3. 200 grams of wood pulp (paper making grade)
	4. 600 milliliters of 10% baking soda solution
	5. 200 grams of 15% sodium hydroxide solution
	6. 100 milliliters carbon disulfide

Summary: High nitrogen content nitrocellulose may be prepared by nitrating wood cellulose with a mixed acid containing 81% nitric acid, 16% sulfuric acid, and 3% water. The wood cellulose is obtained by extracting wood pulp with sodium hydroxide and carbon disulfide. The nitrated product is then collected by filtration, washed, and dried. Note: Numerous modifications to this procedure exist. Commercial & Industrial note: For related, or similar information, see Serial No. 463,830, June 25th, 1930, by Ernest Tschudin, Reinach, Switzerland. Part or parts of this laboratory process may be protected by international, and/or commercial/industrial processes. Before using this process to legally manufacture the mentioned explosive, with intent to sell, consult any protected commercial or industrial processes related to, similar to, or additional to, the process discussed in this procedure. This process may be used to legally prepare the mentioned explosive for laboratory, educational, or research purposes.

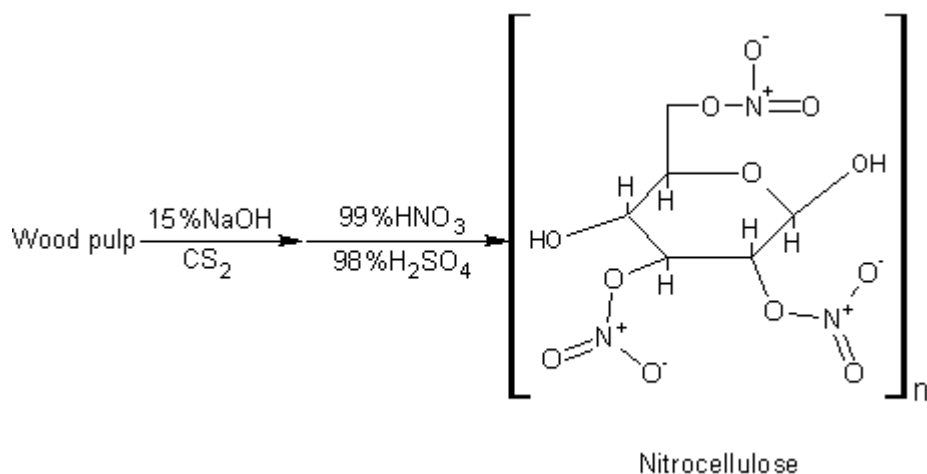

Reaction Equation

Hazards: Warning! Wear gloves and use proper ventilation when handling 99% nitric acid. 99% Nitric acid is a highly poisonous and corrosive liquid, which evolves highly poisonous fumes of nitrogen oxides. Use great care. Use proper ventilation when handling carbon disulfide, and avoid skin absorption or inhalation. Carbon disulfide is very toxic. Caution! Nitrocellulose is a highly flammable solid.

Procedure: Into a beaker, place 200 grams of wood pulp (paper making grade), and then add 140 milliliters of water. Thereafter, add 200 grams of 15% sodium hydroxide, and then heat the mixture for 1 hour at 80 to 100 Celsius. After the heating period, remove the heat source, allow the mixture to cool to room temperature, and then add 100 milliliters of carbon disulfide. Thereafter, stir the resulting gelatinous mass for 1 hour, and then filter-off the mass, wash with several hundred millimeters of warm water, and then dry by pressing it upon a block (to extrude as much of the liquid content as possible, and then air-dry the cellulosic material for several days. Thereafter, place the cellulosic material into a grinding machine, and grind into a fine particle size. After which, place 314 grams of 99% nitric acid into a beaker, and then slowly add 62 grams of 98% sulfuric acid. Afterwards, slowly add 12 grams of water. Then heat this acid mixture to 40 Celsius with constant stirring. Then,

CHAPTER 13: THE PREPERATION OF NITRATE ESTERS

add in portions, the dry cellulosic material obtained earlier over a period of about 30 minutes. After the addition, rapidly stir the reaction mixture at 40 Celsius for 1 hour. Thereafter, remove the heat source, and allow the reaction mixture to cool to room temperature. Then, add the reaction mixture into 1000 milliliters of ice water, and then stir for ten minutes. After which, filter-off the insoluble product, wash with 500 milliliters of cold water, then with four 150-milliliter portions of 10% baking soda solution, and then 500 milliliters of water. After the washing, vacuum dry or air-dry the product.

Notes:

Procedure 13-02C: Preparation of average nitrogen content (12%) Nitrocellulose

Materials:	1. 192 grams 60% nitric acid
	2. 274 grams 98% sulfuric acid
	3. 50 grams of “cellophane”
	4. 50 grams of cotton
	5. 600 milliliters of 10% baking soda solution

Summary: Average nitrogen content nitrocellulose may be prepared by treating cellophane and cotton with a nitrating acid composed of the usual ingredients. The cellophane and cotton are stirred and heated in the acid for about 45 minutes, where upon the mixture is drowned into ice water, and the insoluble mass filtered-off, washed, and then dried. Note: Numerous modifications to this procedure exist. Commercial & Industrial note: For related, or similar information, see Serial No. 5,583, February 8th, 1935, by Hercules Powder Company, to Mahlon G. Milliken, Wilmington, DEL. Part or parts of this laboratory process may be protected by international, and/or commercial/industrial processes. Before using this process to legally manufacture the mentioned explosive, with intent to sell, consult any protected commercial or industrial processes related to, similar to, or additional to, the process discussed in this procedure. This process may be used to legally prepare the mentioned explosive for laboratory, educational, or research purposes.

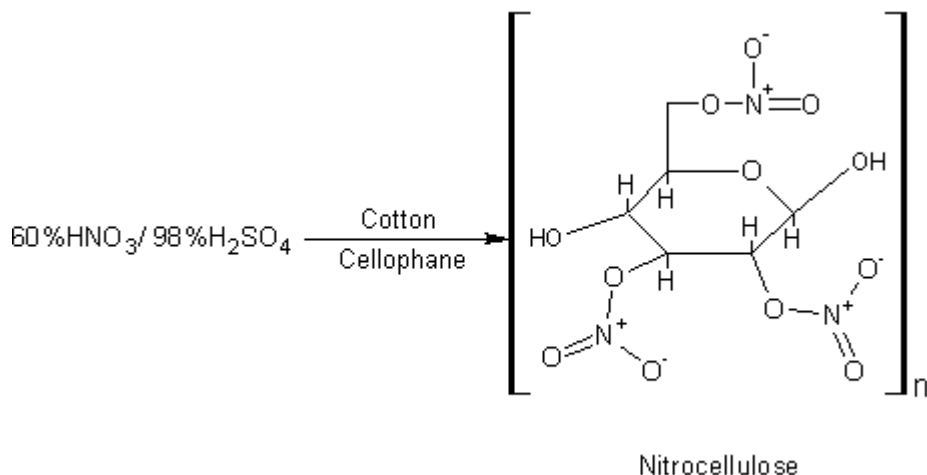

Reaction Equation

Hazards: Wear gloves when handling 60% nitric acid, and 98% sulfuric acid. Extinguish all flames before using cotton, which is highly flammable, and a fire hazard, especially when laboratory chemicals are present. Caution! Nitrocellulose is highly flammable.

Procedure: Into a beaker, place 192 grams of 60% nitric acid, and then carefully add 274 grams of 98% sulfuric acid. Thereafter, heat the acid mixture to about 50 Celsius. When the temperature reaches about 50 Celsius, rapidly add 100 grams of a cellulose mixture, prepared by mixing 50 grams of cellophane pieces (cut into pieces by hand), with 50 grams of ground-up cotton. After the addition, stir the acid mixture rapidly for 90 minutes at 50 Celsius. After heating and stirring for 90 minutes, remove the heat source, and cool the reaction mixture to room temperature. Then drown the reaction mixture into 3000 milliliters of ice water, and then stir the mixture for ten minutes. After which, filter-off the insoluble product, wash with

CHAPTER 13: THE PREPERATION OF NITRATE ESTERS

500 milliliters of cold water, four 150-milliliter portions of 10% baking soda solution, followed by 500 milliliters of water. Then, vacuum dry or air-dry the product. Note: The filter cake may contain some impurities.

Notes:

Procedure 13-02D: Preparation of average nitrogen content (11 to 12%) Nitrocellulose (stabilized form)

Materials:	1. 10 kilograms 98% sulfuric acid
	2. 4 kilograms 70% nitric acid
	3. 2 kilograms standard cotton (commercial bleached cotton)
	4. 2000 milliliters of 10% baking soda solution

Summary: Average content stabilized nitrocellulose is first prepared by treating cotton with 98% sulfuric acid. The action of cotton with 98% sulfuric acid causes a disintegration of the cotton to result. This disintegration must be controlled in order to keep the cotton from under going carbonization. To do this, the sulfuric acid must be cooled to 0 Celsius at all times. By disintegrating the cotton with sulfuric acid at low temperature, a fine activated pulpy-mass is obtained. This activated cellulose mass is readily nitrated with 70% nitric acid at low temperature forming a stabilized form of nitrocellulose. The nitrocellulose is then recovered by drowning the reaction mixture into water, followed by filtering-off the insoluble mass, washing, and then drying. Note: Numerous modifications to this procedure exist. Commercial & Industrial Note: Part or parts of this laboratory process may be protected by international, and/or commercial/industrial processes. Before using this process to legally manufacture the mentioned explosive, with intent to sell, consult any protected commercial or industrial processes related to, similar to, or additional to, the process discussed in this procedure. This process may be used to legally prepare the mentioned explosive for laboratory, educational, or research purposes.

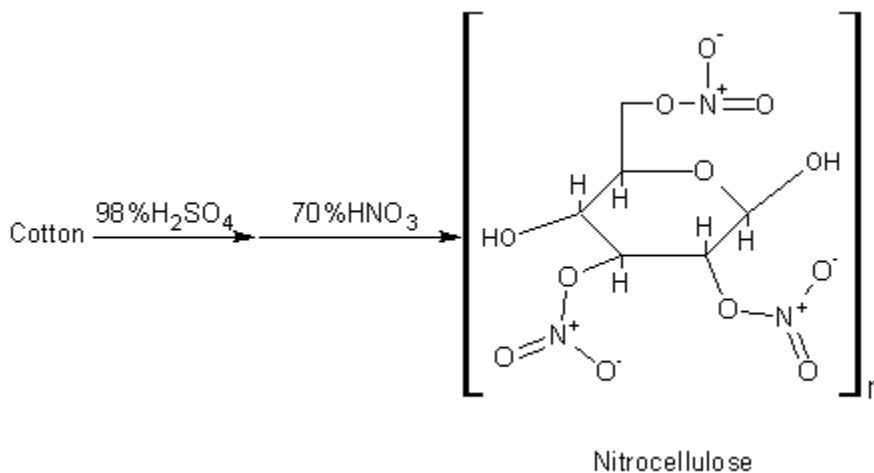

Reaction Equation

Hazards: Wear gloves when handling 70% nitric acid, and 98% sulfuric acid. 98% sulfuric can cause sever burns on prolonged exposure, and can react with clothing. 70% Nitric acid causes yellow staining of skin.

Procedure: Into a beaker, place 10 kilograms of 98% sulfuric acid, and then place this acid mixture into a ice bath and chill to 0 celsius. Thereafter, slowly add in portions, 2 kilograms of standard cotton at a rate sufficient to keep the sulfuric acid at 0 Celsius at all times. During the addition, rapidly stir the sulfuric acid. Note: allowing the temperature to rise may result in carbonization of the cotton. After the addition, continue to stir until a pulpy-mass is obtained. When it is, gradually pour in 4 kilograms of 70% nitric acid at a rate sufficient to keep the reaction mixtures temperature at 0 Celsius. During the nitric acid addition, rapidly stir the reaction mixture. After the addition of the nitric acid, continue to stir at 0 Celsius for 3 hours. After 3 hours, remove the ice bath, and allow the reaction mixture to warm to room temperature. Thereafter, Add 10 liters of cold water to the reaction mixture, and then stir for ten minutes. Then filter-off the precipitated mass, wash with two 500-milliliter portions of cold water, then four 500-milliliter portions of 10% baking soda solution, and then with two 500-milliliter portions of warm water. Afterwards, vacuum dry or air-dry the product.

Notes:

Procedure 13-02E: Preparation of average nitrogen content (11 to 12%) Nitrocellulose

Materials:	1. 3000 grams 98% sulfuric acid
	2. 2840 grams of newspaper (non-recycled newspaper)
	3. 2 kilograms 70% nitric acid
	4. 2000 milliliters of 10% baking soda solution

Summary: Average nitrogen content nitrocellulose is prepared from newspaper, by first treating the moistened newspaper with sulfuric acid at low temperature. The resulting mixture is then stirred for a short period of time, and then filtered-off, washed and dried. Thereafter, the dry cellulosic material is nitrated with mixed nitric and sulfuric acids at 40 Celsius. The resulting reaction mixture is then drowned into ice water, and the insoluble mass is then filtered-off, washed, and dried. Note: Numerous modifications to this procedure exist. Commercial & Industrial Note: Part or parts of this laboratory process may be protected by international, and/or commercial/industrial processes. Before using this process to legally manufacture the mentioned explosive, with intent to sell, consult any protected commercial or industrial processes related to, similar to, or additional to, the process discussed in this procedure. This process may be used to legally prepare the mentioned explosive for laboratory, educational, or research purposes.

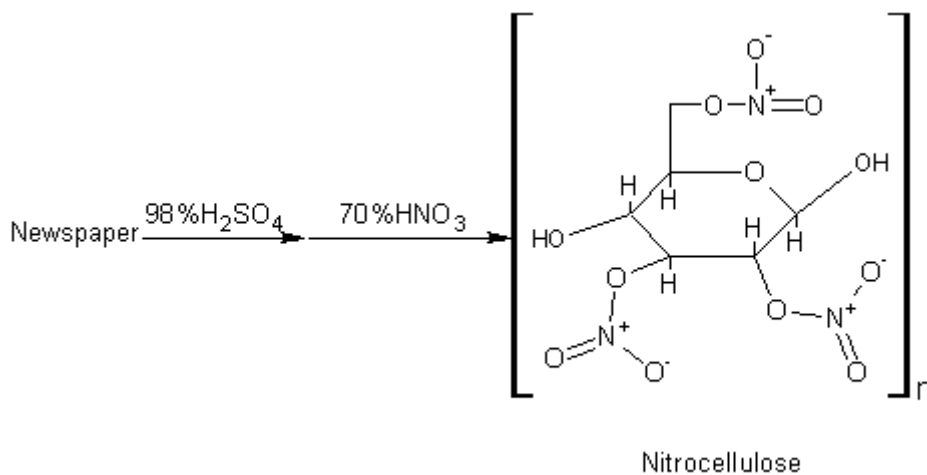
*Reaction Equation*

Hazards: Wear gloves when handling 70% nitric acid, and 98% sulfuric acid. 98% sulfuric can cause severe burns on prolonged exposure, and can react with clothing. 70% Nitric acid causes yellow staining of skin.

Procedure: Into a beaker, place 2 kilograms of 98% sulfuric acid, and then place this acid mixture into a ice bath and chill to 0 Celsius. Thereafter, place 2840 grams of newspaper into a separate beaker, and then moisten the newspaper by the addition of a small amount of water. Note: add just enough water to moisten the paper, but not to the point where the newspaper becomes fragile, and easily torn. Then, add this moistened newspaper, in portions, to the sulfuric acid at such a rate to keep the sulfuric acid at 0 Celsius at all times. During the addition, rapidly stir the sulfuric acid. After the addition, rapidly stir the acid mixture at 0 Celsius for about 1 hour. Then, filter-off the pulpy cellulose mass, wash with 1000 milliliters of warm water, and then dry by pressing the cellulosic mass to exclude as much of the liquids as possible. Thereafter, allow the cellulosic mass to dry at room temperature for several days. Thereafter, place the dry cellulosic material into a grinding machine, and grind into a fine particle size. After which, place 2 kilograms of 70% nitric acid into a beaker, and then carefully add 1000 grams of 98% sulfuric acid. Then heat this acid mixture to 40 Celsius with constant stirring. Thereafter, add in portions, the dry cellulosic material obtained earlier over a period of about 30 minutes. After the addition, rapidly stir the reaction mixture at 40 Celsius for 2 hours. Thereafter, remove the heat source, and allow the reaction mixture to cool to room temperature. Then add the reaction mixture to 10-liters of ice, and then stir the mixture for ten minutes. After which, filter-off the insoluble product, wash with 500 milliliters of cold water, then with four 500-milliliter portions of 10% baking soda solution, and then 1000 milliliters of water. After the washing, vacuum dry or air-dry the product

Notes:

Procedure 13-02F: Preparation of low nitrogen content (11%) Nitrocellulose

Materials:	1. 314 grams 99% nitric acid
	2. 140 grams 98% sulfuric acid
	3. 106 grams of wood cellulose (94% dry bases)
	4. 600 milliliters of 10% baking soda solution

Summary: Low nitrogen content nitrocellulose may be prepared by reacting wood cellulose with a nitrating acid composed of primarily nitric acid. The reaction mixture is treated for 1 hour at 40 Celsius with rapid stirring. Thereafter, the heat is removed, and the reaction mixture drowned into ice water. The resulting insoluble mass is filtered-off, washed, and then dried. Note: Numerous modifications to this procedure exist. Commercial & Industrial note: For related, or similar information, see Serial No. 9,123, March 2nd, 1935, by E.I. Dupont de Nemours & company, to Roderick K. Eskew, Portland, Maine. Part or parts of this laboratory process may be protected by international, and/or commercial/industrial processes. Before using this process to legally manufacture the mentioned explosive, with intent to sell, consult any protected commercial or industrial processes related to, similar to, or additional to, the process discussed in this procedure. This process may be used to legally prepare the mentioned explosive for laboratory, educational, or research purposes.

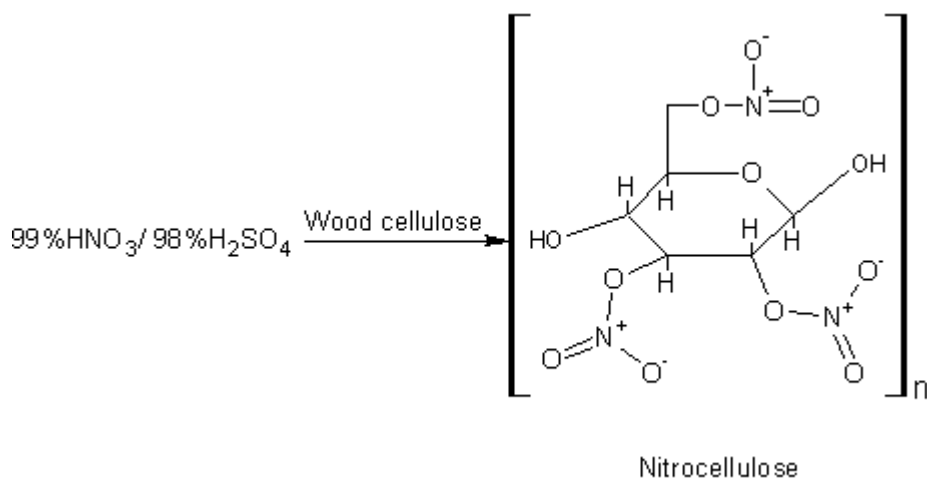
*Reaction Equation*

Hazards: Warning! Wear gloves and use proper ventilation when handling 99% nitric acid. 99% Nitric acid is a highly poisonous and corrosive liquid, which evolves highly poisonous fumes of nitrogen oxides. Use great care. Caution! Nitrocellulose is a highly flammable solid.

Procedure: Into a beaker, place 314 grams of 99% nitric acid, and then 140 grams of 98% sulfuric acid. Thereafter, slowly add 64 grams of water. Then heat this nitrating acid mixture to about 40 Celsius with rapid stirring, and then add 106 grams of wood cellulose (94% dry bases; obtained from alkali lye extraction using a boiling 20% sodium hydroxide solution upon wood chips). After the addition, rapidly stir the acid mixture at 40 Celsius for 1 hour, and then cool the reaction mixture to room temperature. Then drown the reaction mixture into 1500 milliliters of ice water, and then stir the mixture for ten minutes. Then, filter-off the insoluble product, wash with 1000 milliliters of cold water, four 150-milliliter portions of 10% baking soda solution, followed by 1000 milliliters of water. Then, vacuum dry or air-dry the product. Note: The filter cake may contain some impurities.

Notes:

Nitrocellulose high performance gun propellant (military grade gunpowder; double based)

Place 178 grams of water into a 1600-milliliter beaker and then heat to 50 Celsius. Then add 60 grams of nitrocellulose (13 to 14% nitrogen content), followed by 354 grams of ethyl acetate, and then 125.6 grams of nitroglycerine. Shortly thereafter, add 1.2 grams of diethyldiphenylurea while stirring the contents of the beaker. After the addition of the ingredients, continue stirring at 50 Celsius for 30 minutes. After 30 minutes, add 14 grams of potassium nitrate and 13.2 grams of 4,4'-diphenylmethane diisocyanate, and then continue stirring the mixture at 50 Celsius for 30 minutes. After which, add a glue solution prepared by mixing 6.6 grams of standard glue with 370 milliliters of water, and then after the addition of the glue solution, rapidly stir the mixture at 50 Celsius for 40 minutes. Then, place the entire mixture into a shallow pan with a high surface area and allow it to evaporate until the smell of ethyl acetate is gone. When the smell of ethyl acetate is gone, place the remaining contents of the pan into 2000 milliliters of water, and then heat the mixture with stirring at 50 Celsius for 2 hours. After 2 hours, place the entire mixture into a centrifugal machine and spin at high RPM to separate the water from the solids. Now, remove the solids from the centrifugal machine by pouring off the water, and then vacuum dry the solids. Afterwards, place the dry solids into a plastic bag and then add 100 milligrams of graphite, and shake the bag thoroughly to coat the solids with the graphite. Then remove the coated solids from the plastic bag, and place the solids onto a tray and then dry in an oven at 60 Celsius for 1 day. The resulting granular propellant will have a flat, circular plate-like shape, or flat oval plate-like shape. Commercial & Industrial note: For related, or similar information, see Application No. 964,040, November 27, 1978, by Nippon Oil and Fats Co., Ltd., to Kazuhiro Inoue, Aichi, JP, and Fumio Matsui, Handa, JP. Part or parts of this laboratory process may be protected by international, and/or commercial/industrial processes. Before using this process to legally manufacture the mentioned explosive, with intent to sell, consult any protected commercial or industrial processes related to, similar to, or additional to, the process discussed in this procedure. This process may be used to legally prepare the mentioned explosive for laboratory, educational, or research purposes.

Nitrocellulose high performance gun propellant (military grade gunpowder; double based)

Into a mixing blender, equipped with a plastic mixing blade, preferably a Teflon blade, place 126 grams of 13 to 14% nitrogen content nitrocellulose, and 2 grams of potassium sulfate. Immediately thereafter, begin moderate blending for 20 minutes. Thereafter, carefully add 34 grams of NENA, and then 34 grams of DIANP. During the addition, moderately blend the mixture (low speed). After the addition, moderately blend the mixture for 10 minutes. Then add 3 grams of diethyldiphenylurea, and then moderately blend the mixture for 10 minutes. After stirring for 10 minutes, add 120 grams of a solvent mixture prepared by mixing 48 grams of diethyl ether with 72 grams of 95% ethanol. After the addition of the solvent mixture, increase the blending speed to rapid, and then continue to blend for 3 hours at room temperature. After mixing for 3 hours, remove the "dough" like material from the mixing blender. What you do next is up to you; for example, the material may be charged into a standard extruding machine with multiple holes (1 to 2mm each hole), and then extruded under pressure into strands of average length (5 to 10 cm each strand). After which, the strands can be cut into small pieces (granules) 1 to 2 mm thick each piece. The cut pieces are then cured on shallow pans for several days prior to use. The resulting granules can then be charged into any desirable cartridge case. Instead of extruding the dough, you can place it onto a pan and allow it to cure for several days. Thereafter, place the dried mass into a roller machine, then add 1000 grams of steel balls, and then tumble the contents to form granules or powder of any desired size. Note: the rotation speed of the roller machine, the size of the steel balls, and the time of rotating are dependent on the size of the desired granules, or powder. After the roller action, the granules or powder can be separated into their distinct sizes by using different sized sieves (mesh). Commercial & Industrial Note: Part or parts of this laboratory process may be protected by international, and/or commercial/industrial processes. Before using this process to legally manufacture the mentioned explosive, with intent to sell, consult any protected commercial or industrial processes related to, similar to, or additional to, the process discussed in this procedure. This process may be used to legally prepare the mentioned explosive for laboratory, educational, or research purposes.

Nitrocellulose "smokeless powder"

Into a mixing blender, add 200 grams of 11 to 14% nitrogen content nitrocellulose, and then add 82 milliliters of cold water, and then rapidly blend the mixture. Thereafter, add a solvent mixture prepared by mixing 210 grams of diethyl ether with 90 milliliters of 95% ethanol. During the addition, rapidly blend the mixture, and then thereafter, blend the mixture rapidly for ten minutes. Then, add 30 grams of potassium nitrate, and then 3 grams of diphenylamine. Then rapidly blend the mixture for 1 hour at room temperature. After blending for 1 hour, pour in 1000 milliliters of cold water, and then blend at a slow speed for about 10 minutes. After which, filter-off any insoluble grains, and then place these grains into an extruding machine, or place them onto a shallow pan and allow them to cure for several days. If using an extruding machine, the holes should be of typical diameter. After the extrusion process, cut the strands into typical sized granules, and then cure them for several days at room temperature. If the grains after filtration, were cured for several days, they may be separated into their various sizes by using

CHAPTER 13: THE PREPERATION OF NITRATE ESTERS

different sizes of mesh sieves (after the roll milling process). Commercial & Industrial note: Part or parts of this laboratory process may be protected by international, and/or commercial/industrial processes. Before using this process to legally manufacture the mentioned explosive, with intent to sell, consult any protected commercial or industrial processes related to, similar to, or additional to, the process discussed in this procedure. This process may be used to legally prepare the mentioned explosive for laboratory, educational, or research purposes.

Nitrocellulose blasting powder

Into a suitable blender, add 52 grams of freshly prepared, filtered-off, wet nitrocellulose, and then add 6 grams of glycerin, followed by 1 gram of oleic acid (olive oil may be used). Then begin blending of the ingredients at a moderate speed. Shortly thereafter, gradually add in 152 grams of ammonium nitrate, while stirring the mixture moderately. After adding the ammonium nitrate, increase the mixing speed to fast, and then blend for 1 hour to form a uniform blended mixture. After which, stop the blending, and then place the doughy mixture onto a shallow tray, and then dry in an oven at 50 celsius until the water has been removed. Thereafter, remove the dry mixture, and then simply pack it into a waxed coated cardboard tube, and then fold over both ends, and seal the folded ends with molten wax. The cardboard tube in practice should be about 2 inches wide, by 6 inches long. A blasting cap or detonator is required for initiation. Commercial & Industrial note: Part or parts of this laboratory process may be protected by international, and/or commercial/industrial processes. Before using this process to legally manufacture the mentioned explosive, with intent to sell, consult any protected commercial or industrial processes related to, similar to, or additional to, the process discussed in this procedure. This process may be used to legally prepare the mentioned explosive for laboratory, educational, or research purposes.

Nitrocellulose blasting powder (suitable for making anti-personnel bursting munitions)

Into a crucible, add 160 grams of dry powdered nitrocellulose, 200 grams of potassium nitrate, and then 40 grams of powdered sulfur. Thereafter, vigorously blend the mixture for several hours to obtain a uniform mixture. After the blending period, press it into any desirable container under high pressure. The containers may be made of steel/iron, aluminum, lead, glass, tin, or copper. For best results, a thick walled steel tube, 1 inch wide by 3 inches long, sealed at both ends with steel end caps works (remember a blasting cap hole must be drilled into one of the end caps prior to use; the blasting cap hole, after insertion of the blasting cap, may be sealed with grease). This will produce a casualty radius of about 5 meters. Larger steel tubes may be used, but larger devices are not recommended for anti-personnel use, because large devices tend to blow upwards, decreasing the effectiveness of shrapnel. For demolitions use, simply pack the dried well-mixed explosive into a cardboard tube 2 inches wide by 6 inches long, and then seal both ends in the usual manner. Requires a blasting cap or detonator for initiation. Commercial & Industrial note: Part or parts of this laboratory process may be protected by international, and/or commercial/industrial processes. Before using this process to legally manufacture the mentioned explosive, with intent to sell, consult any protected commercial or industrial processes related to, similar to, or additional to, the process discussed in this procedure. This process may be used to legally prepare the mentioned explosive for laboratory, educational, or research purposes.

13-03. ETN. *Erythritol tetranitrate*

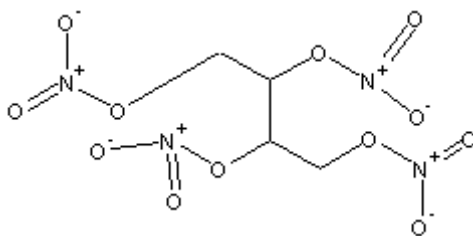

ETN

ETN forms colorless or white crystals, leaflets, or powder with a melting point of 61 Celsius. It is soluble in alcohol, ether, and glycerol, but insoluble in water. ETN explodes on strong percussion, but still requires a primary explosive for proper initiation when used in explosives compositions. ETN is used as a substitute for PETN in blasting cords, for use in explosives compositions, and nitroglycerine free dynamites when mixed with TNT, nitrocellulose, or ammonium nitrate.

Molecular weight: 302.108	Flammability: May flash when strongly ignited
Detonating velocity: Similar to PETN	Toxicity: Moderate
Sensitivity: Moderate	Classification: Secondary explosive
Stability: Good	Overall value (as secondary explosive): Moderate

Procedure 13-03A: Preparation of ETN

Materials:	1. 110 grams 98% sulfuric acid
	2. 20 grams of erythritol
	3. 140 grams of 90% nitric acid
	4. 200 milliliters of 10% sodium carbonate solution
	5. 1000 milliliters of 95% ethanol

Summary: ETN is prepared by dissolving erythritol into 98% sulfuric acid, followed by treatment with 90% nitric acid. The reaction mixture is stirred for a short time afterwards, and then allowed to stand. The whole reaction mixture is then mixed with cold water, which causes precipitation of the ETN. The ETN is then dissolved into warm 95% ethanol, and then after filtration (to remove impurities), the ethanol mixture is treated with an excess of cold water. The addition of the cold water causes the ETN to precipitate. The ETN is then washed, and then dried. Commercial & Industrial note: For related, or similar information, see Serial No. 184,180, November 20th, 1928, by E.I. Dupont de Nemours & Company, to Frank H. Bergeim, Woodbury, NJ. Part or parts of this laboratory process may be protected by international, and/or commercial/industrial processes. Before using this process to legally manufacture the mentioned explosive, with intent to sell, consult any protected commercial or industrial processes related to, similar to, or additional to, the process discussed in this procedure. This process may be used to legally prepare the mentioned explosive for laboratory, educational, or research purposes.

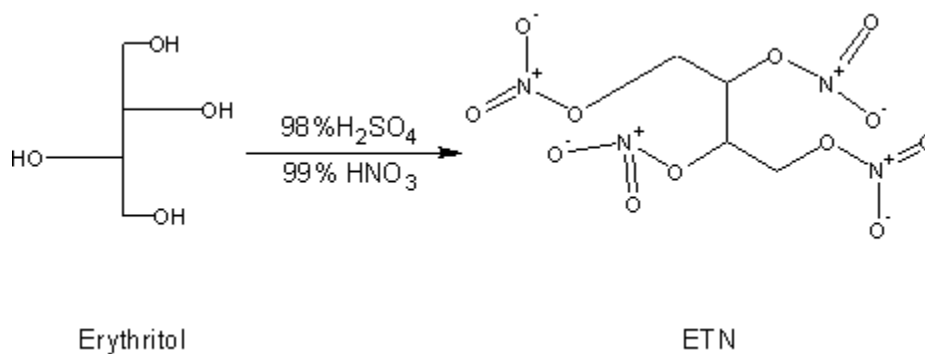
*Reaction Equation*

Hazards: Use caution when handling 90% nitric acid. 90% nitric acid is highly toxic, and emits highly poisonous fumes of nitrogen oxides; use caution. Wear gloves when handling 98% sulfuric acid.

Procedure: Add 110 grams of 98% sulfuric acid into a suitable flask, and then place the flask into an ice water bath. When the acid is cooled to about 10 Celsius, gradually add 20 grams of erythritol over a period sufficient enough to keep the acid at a temperature below 40 Celsius. Note: If the temperature rises above 40 Celsius, carbonization of the erythritol will begin. During the addition, rapidly stir the sulfuric acid. After the addition of the erythritol, place 140 grams of 90% nitric acid into a clean flask, and then cool this flask in a hot water bath at about 30 Celsius. After which, add the sulfuric acid/erythritol mixture over a period suitable to keep the nitric acid at a temperature below 60 Celsius. During the addition, rapidly stir the nitric acid. After the addition, rapidly stir the reaction mixture for 1 hour. After stirring for about 1 hour, stop stirring, and then allow the reaction mixture to stand for 30 minutes. Then, pour the entire reaction mixture into 1000 milliliters of ice water. Thereafter, filter-off the precipitated product, wash with several hundred milliliters of cold water, 200 milliliters of 10% sodium carbonate solution, and then several hundred milliliters of warm water. After washing, vacuum dry or air-dry the product. Then add and dissolve the product into 1000 milliliters of warm 95% ethanol. After which, filter-off any insoluble impurities, and then add 1000 milliliters of ice-cold water, and stir the mixture for ten minutes. After which, filter-off the predicated product, wash with several hundred milliliters of cold water, and then vacuum dry or air-dry the product. The result will be high purity ETN.

Notes:

13-04. PEN. *Pentaerythritol trinitrate*

CHAPTER 13: THE PREPERATION OF NITRATE ESTERS

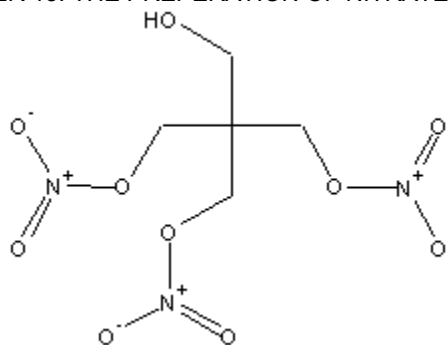

PEN

Uses: Addictive with PETN in explosives compositions, ingredient in high performance rocket propellants with nitrocellulose, or RDX, and in plastic explosives when mixed with RDX, TNT, HMX, PETN, followed by treatment with a high energy plasticizer.

Molecular weight: 271.138	Flammability: May flash when strongly ignited
Detonating velocity: Similar to PETN	Toxicity: Moderate
Sensitivity: Moderate	Classification: Secondary explosive
Stability: Very good	Overall value (as secondary explosive): Moderate

Procedure 13-04A: Preparation of PEN (PETN is also formed)

Materials:	1. 1360 grams pentaerythritol
	2. 4380 grams 99% nitric acid
	3. 4420 grams 93% sulfuric acid
	4. 16,360 grams methylene chloride
	5. 48 grams urea
	6. 80 grams of baking soda
	7. 860 grams diethyl ether

Summary: PEN is prepared by reacting pentaerythritol with 99% nitric acid in the presence of urea, methylene chloride, and sulfuric acid. After the reaction, the mixture is separated into two layers. The upper layer contains the PEN, along with some PETN. The bottom acid layer is then extracted with additional methylene chloride, and all methylene chloride layers are then combined, and then evaporated. The resulting mother liquor is then treated with diethyl ether, evaporated, and the PEN collected by filtration, washed, and dried. Note: PETN is a useful by-product in this procedure. Commercial & Industrial note: For related, or similar information, see Serial No. 644,957, October 29th, 1968, by Rhom & Haas Company, to Henry A. Rolewicz, Charles D. Grimes, Jr., and Kenyon Stevenson, Jr., both of Huntsville Alabama. Part or parts of this laboratory process may be protected by international, and/or commercial/industrial processes. Before using this process to legally manufacture the mentioned explosive, with intent to sell, consult any protected commercial or industrial processes related to, similar to, or additional to, the process discussed in this procedure. This process may be used to legally prepare the mentioned explosive for laboratory, educational, or research purposes.

CHAPTER 13: THE PREPERATION OF NITRATE ESTERS

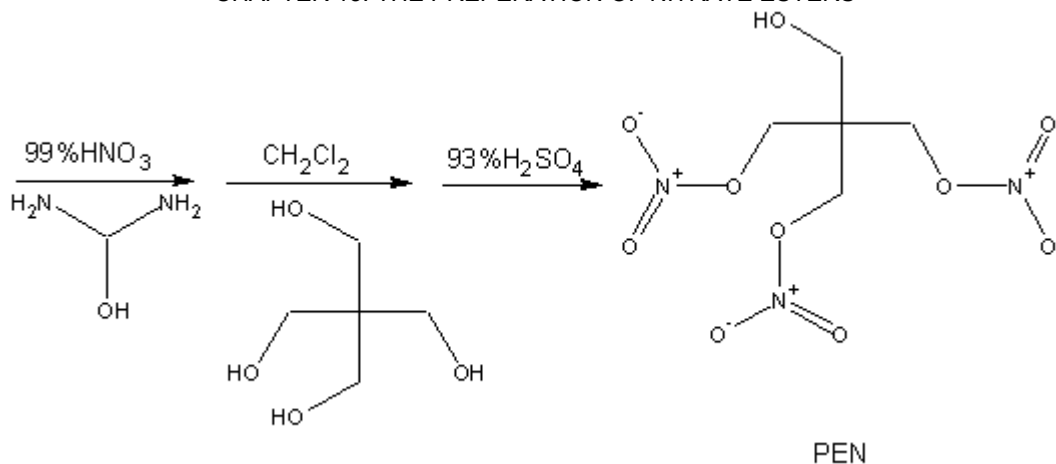
Reaction Equation

Hazards: Use extreme caution when handling 99% nitric acid. 99% Nitric acid is highly volatile, and emits highly poisonous fumes of nitrogen oxides. Wear gloves, proper lab clothing, and use maximum ventilation when handling. Wear gloves and proper clothing when handling 93% sulfuric acid. Diethyl ether is highly flammable and forms explosive peroxides when exposed to air. Perform the peroxide test before using, and use maximum ventilation when handling; diethyl ether is a narcotic in high concentrations, avoid inhalation.

Procedure: Into a large flask, equipped with a mechanical stirrer, place 1600 grams of water, and then 4380 grams of 99% nitric acid. Then moderately rapidly pass dry air into this acid mixture for 6 minutes to expel any nitrogen oxides. Afterwards, add 32 grams of urea in one portion, and then moderately rapidly pass air through the acid mixture once more for about 2 minutes. Then rapidly add 9080 grams of methylene chloride into the acid mixture, and then cool the entire mixture to about 0 Celsius using an ice bath. When the acid mixture reaches about 0 Celsius, carefully add 1360 grams of pentaerythritol in several portions while keeping the acid mixture at 0 Celsius and stirring rapidly. After the addition, stir at 0 Celsius for about 20 minutes. Thereafter, add 4420 grams of 93% sulfuric acid over a period of 1 hour while stirring the reaction mixture and keeping its temperature at 0 Celsius. After the sulfuric acid addition, continue to stir the reaction mixture at 0 Celsius with stirring for 1 hour. After 1 hour, stop stirring, and allow two layers to form. After which, decant the upper organic layer and set aside for later use. Then place the flask containing the bottom acid layer back into the ice bath, and then add 16 grams of urea to the bottom acid layer and then continue stirring while keeping the temperature around 0 Celsius. After which, add 7280 grams of methylene chloride to the bottom acid layer, and then continue to stir at 0 Celsius for 1 hour. After 1 hour, stop the stirring and allow two layers to form. Then decant the upper organic layer, and add it to the first decanted organic layer. Then add 10.6 liters of water to the bottom acid layer. Note: After the addition of the water, PETN will separate out and a small amount of methylene chloride will also separate as a layer. Decant this small upper organic layer of methylene chloride, and add it to the other two decanted organic layers. Then, filter-off the PETN precipitate, wash with plenty of warm water, and then vacuum dry or air-dry the product. Then wash the three layers of decanted methylene chloride with 20 liters of cold water, and then add 80 grams of baking soda to the methylene chloride. Afterwards, stir the mixture for ten minutes, and then filter-off the baking soda. After which, place the methylene chloride into a distillation apparatus, and then distill the methylene chloride at 40 Celsius until 1/5th of the total volume of the methylene chloride mixture remains. Then remove the heat source, and then place the remaining methylene chloride mixture into a suitable flask, and then add 860 grams of diethyl ether. After which cover the flask and place it into a refrigerator cooled at 10 Celsius for three hours. After 3 hours, remove the flask from the refrigerator, and then filter-off any precipitated PETN. Note: wash the PETN with plenty of warm water, and vacuum dry or air-dry. Finally, place the filtered liquid into a distillation apparatus and distill at about 40 Celsius until dry solid remains (a rotary evaporator with reduced pressure works faster and better). When dry solid remains, remove the PEN from the flask, wash with plenty of warm water, and then vacuum dry air dry the product. The result will be about 1600 grams of PEN. Note: about 800 grams of PETN will be recovered as well.

Notes:

Procedure 13-04B: Preparation of PEN (PETN is also formed)

CHAPTER 13: THE PREPERATION OF NITRATE ESTERS

Materials:	1. 48 grams pentaerythritol
	2. 136 milliliters 90% nitric acid
	3. 114 milliliters 98% sulfuric acid
	4. 2 liters methylene chloride
	5. 2 grams urea
	6. 200 milliliters 10% baking soda solution

Summary: PEN can be made in a modified manner by treating 90% nitric acid with pentaerythritol in the presence of urea, sulfuric acid, and methylene chloride. After the reaction, the upper methylene chloride layer is decanted, and the bottom acid layer is added into water to precipitate PETN by-product. The upper methylene chloride layer is then evaporated to a small volume, and an additional crop of PETN precipitates. After filtering-off this crop of PETN, the remaining methylene chloride is evaporated to dryness. The dry solid remaining is the desired product. Commercial & Industrial note: For related, or similar information, see Serial No. 644,957, October 29th, 1968, by Rhom & Haas Company, to Henry A. Rolewicz, Charles D. Grimes, Jr., and Kenyon Stevenson, Jr., both of Huntsville Alabama. Part or parts of this laboratory process may be protected by international, and/or commercial/industrial processes. Before using this process to legally manufacture the mentioned explosive, with intent to sell, consult any protected commercial or industrial processes related to, similar to, or additional to, the process discussed in this procedure. This process may be used to legally prepare the mentioned explosive for laboratory, educational, or research purposes.

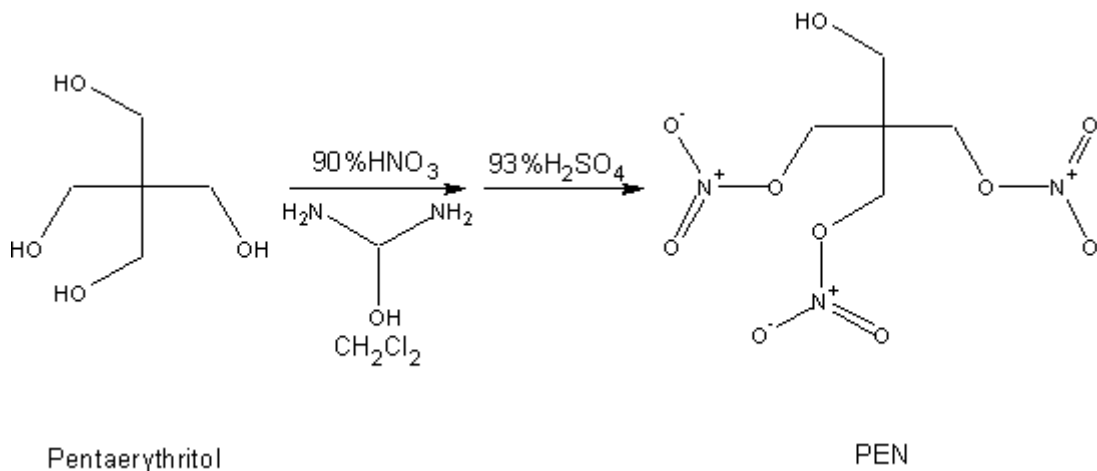
Reaction Equation

Hazards: Use extreme caution when handling 90% nitric acid. 90% Nitric acid is highly volatile, and emits highly poisonous fumes of nitrogen oxides. Wear gloves, proper lab clothing, and use maximum ventilation when handling. Wear gloves and proper clothing when handling 98% sulfuric acid.

Procedure: Into a suitable flask fitted with a mechanical stirrer, add 136 milliliters of 90% nitric acid. After which, bubble dry air through this acid mixture for 30 minutes (to remove gaseous impurities). Then prepare a small solution by dissolving 2 grams of urea into 4 milliliters of water, and then add this urea solution to the nitric acid with stirring. Then continue bubbling dry air into the acid mixture for an additional 30 minutes. Then add 2 liters of methylene chloride and then chill the entire mixture to 0 Celsius using an ice bath. After which, add 48 grams of pentaerythritol while maintaining the temperature of the reaction mixture at 0 Celsius, and stirring. After the pentaerythritol has dissolved, add 114 milliliters of 98% sulfuric acid. Note: during the addition of the sulfuric acid, a slight exothermic reaction occurs. Maintain the reaction temperature at 0 Celsius during the addition, while stirring the reaction mixture. After the sulfuric acid addition, bubble dry air through the reaction mixture, and stir the reaction mixture rapidly for 1½ hours at 0 Celsius. Afterwards, decant the upper organic layer, and set aside for later use. Then add the bottom acid layer into 600 milliliters of ice water while stirring. Then filter-off the precipitated PETN, wash with water, and then dry. The result of this precipitate will be about 11 grams of PETN. Then wash the upper methylene chloride organic layer with 300 milliliters of ice water, then with 200 milliliters of 10% baking soda solution, and finally with 200 milliliters of ice water. Afterwards, add 100 grams of anhydrous magnesium sulfate, and stir the mixture for ten minutes. Then filter-off the magnesium sulfate, and place the methylene chloride organic layer into a distillation apparatus and distil at 40 Celsius until the methylene chloride layer is only 160 milliliters in volume. After which, remove the heat source, and then filter the solution hot. The filtered-off solid will be another crop of PETN by-product. Wash this PETN by-product with plenty of water, and then vacuum dry or air-dry the PETN. Then place the remaining methylene chloride back

into the distillation apparatus, and distill-off the remaining solvent until dry solid remains (a rotary evaporator works best). Then remove the heat source, then remove the dry solid, wash with plenty of cold water, and then vacuum dry or air-dry the solid. The result will be 73.6 grams of PEN.

Notes:

13-05. PETN. *Pentaerythritol tetranitrate; 2,2-Bis[(nitrooxy)-methyl]-1,3-propanediol dinitrate*

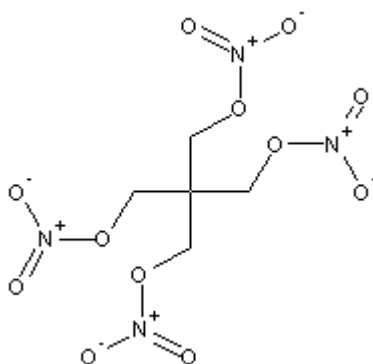

PETN

PETN forms white crystals with a melting point of 140 Celsius. It is soluble in acetone, but insoluble in water. It is only slightly soluble in alcohol or ether. PETN is more sensitive than most secondary explosives, and can detonate more readily upon percussion—however it still requires a primary explosive for initiation under most conditions. PETN is an important military explosive and is used quite frequently in detonating cords, primer cords, demolition charges, and in some cases, rocket propellants.

Molecular weight: 316.135	Flammability: May flash when ignited
Detonating velocity: 8260	Toxicity: Moderate
Sensitivity: Moderate	Classification: Secondary explosive
Stability: Good	Overall value (as secondary explosive): Extremely high

Procedure 13-05A: Preparation of PETN

Materials:	1. 100 grams pentaerythritol
	2. 90 grams 90% nitric acid
	3. 500 milliliters of acetone
	4. 500 milliliters of 95% ethanol

Summary: PETN is prepared by reacting pentaerythritol with fuming nitric acid, followed by drowning the reaction mixture in water to precipitate the PETN. The PETN is then collected by filtration, washed, and then dried. Commercial & Industrial note: For related, or similar information, see Serial No. 332,266, September 1st, 1942, by Trojan Powder company, to Joseph A. Wyler Allentown, PA. Part or parts of this laboratory process may be protected by international, and/or commercial/industrial processes. Before using this process to legally manufacture the mentioned explosive, with intent to sell, consult any protected commercial or industrial processes related to, similar to, or additional to, the process discussed in this procedure. This process may be used to legally prepare the mentioned explosive for laboratory, educational, or research purposes.

Hazards: Wear gloves and use proper ventilation when handling 90% nitric acid. 90% Nitric acid is highly toxic and corrosive. Use caution.

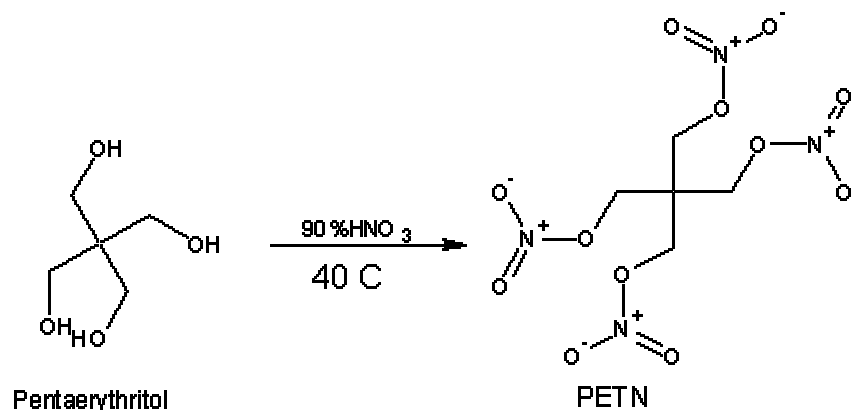
*Reaction Equation*

Procedure: Add 90 grams of 90% nitric acid to a 500-milliliter Erlenmeyer flask and then begin stirring. Then add 100 grams of powdered pentaerythritol in small increments over a period of 2 hours while keeping the 90% nitric acid at a temperature around 40 Celsius at all times (do not let the reaction temperature rise above 45 Celsius). After addition of the pentaerythritol, cool the reaction mixture to room temperature. When the reaction mixture reaches room temperature, add the entire reaction mixture to 500 milliliters of ice-cold water. Then, filter-off the precipitated PETN solid, wash with 800 milliliters of cold water, and then vacuum dry or air-dry the product (do not use heat to dry the PETN). Purify the PETN by recrystallizing from 1000 milliliters of a 50%acetone/50%alcohol mixture (prepare by dissolving 500 milliliters of acetone to 500 milliliters of 95% ethanol), then wash the product with 1000 milliliters of cold water, and then vacuum dry or air-dry.

Notes:

Procedure 13-05B: Preparation of PETN

Materials:	1. 200 grams pentaerythritol
	2. 1260 milliliters 99% nitric acid
	3. 1100 milliliters of acetone
	4. 1100 milliliters of 95% ethanol

Summary: PETN is easily prepared by reacting erythritol with 99% nitric acid. The resulting reaction mixture is the filtered, and the PETN washed, dried, and then recrystallized from a double solvent. Commercial & Industrial note: For related, or similar information, see Serial No. 332,266, September 1st, 1942, by Trojan Powder company, to Joseph A. Wyler Allentown, PA. Part or parts of this laboratory process may be protected by international, and/or commercial/industrial processes. Before using this process to legally manufacture the mentioned explosive, with intent to sell, consult any protected commercial or industrial processes related to, similar to, or additional to, the process discussed in this procedure. This process may be used to legally prepare the mentioned explosive for laboratory, educational, or research purposes.

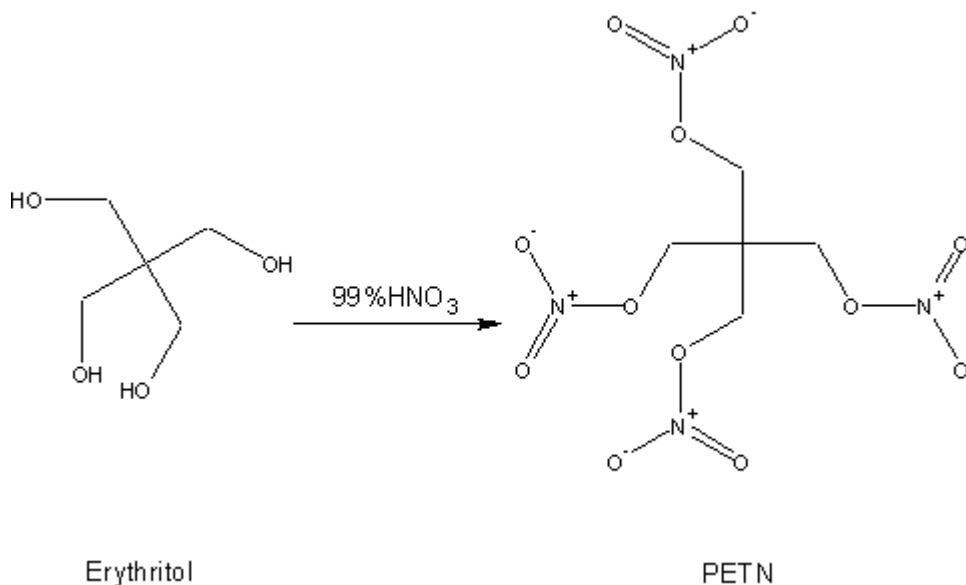
*Reaction Equation*

Hazards: Use extreme caution when handling 99% nitric acid. 99% Nitric acid is highly volatile, and emits highly poisonous fumes of nitrogen oxides.

Procedure: Note: This procedure uses an excessive amount of 99% nitric acid to properly carryout the reaction. This excessive amount of acid can be recovered by treating the reaction mixture (after complete removal of the product) with methylene chloride to recover the nitric acid. Prior to this action, a small amount of sulfuric acid should be added to the reaction mixture. Afterwards, the reaction mixture should be extracted with several volumes of methylene chloride. These combined volumes can then be carefully distilled to recover the nitric acid of 99% purity (see nitric acid, 90% and 99% respectively).

Place 1260 milliliters of 99% nitric acid into a suitable flask, and then cool to below 30 Celsius using a cold water bath. Afterwards, slowly add 200 grams of pentaerythritol over a period of 1 hour while stirring the nitric acid and maintaining its temperature below 30 Celsius. After the addition, continue to stir the reaction mixture for another 1 hour, and then filter-off the precipitated PETN, wash with plenty of warm water, 200 milliliters of 10% baking soda solution, and then with plenty of warm water. After washing the PETN, vacuum dry or air-dry the product. Afterwards, recrystallize the crude dry PETN from a solvent mixture prepared by adding 1100 milliliters of acetone to 1100 milliliters of 95% ethanol. Then, wash with several hundred milliliters of cold water, and then vacuum dry or air-dry the product. The result will be about 430 grams of PETN. Note: A bi-product high explosive, dipentaerythritol hexantrate can be recovered by treating the reaction mixture, after filtering-off the PETN, with 1000 milliliters of ice water. This causes the slow precipitation of dipentaerythritol hexantrate; after treating the reaction mixture with water, allow the mixture to stand, after which, filter-off the dipentaerythritol hexantrate, and then wash with plenty of warm water followed by vacuum drying.

Notes:

Procedure 13-05C: Preparation of PETN

Materials:	1. 20 grams pentaerythritol
	2. 120 grams 90% nitric acid
	3. 1000 milliliters of acetone
	4. 130 grams of 98% sulfuric acid
	5. 200 milliliters of 10% sodium carbonate solution

Summary: PETN can be prepared by a modified process using concentrated sulfuric acid. Pentaerythritol is dissolved into 98% sulfuric acid, and then this acid mixture is treated with 90% nitric acid. After the addition of the sulfuric

CHAPTER 13: THE PREPERATION OF NITRATE ESTERS

acid/pentaerythritol mixture, the reaction mixture is drowned into water, and the PETN collected by filtration. Afterwards, the PETN is purified by dissolving it into acetone, followed by treatment with excess water. The water causes the insoluble PETN product to precipitate. Commercial & Industrial note: For related, or similar information, see Serial No. 332,266, September 1st, 1942, by Trojan Powder company, to Joseph A. Wyler Allentown, PA. Part or parts of this laboratory process may be protected by international, and/or commercial/industrial processes. Before using this process to legally manufacture the mentioned explosive, with intent to sell, consult any protected commercial or industrial processes related to, similar to, or additional to, the process discussed in this procedure. This process may be used to legally prepare the mentioned explosive for laboratory, educational, or research purposes.

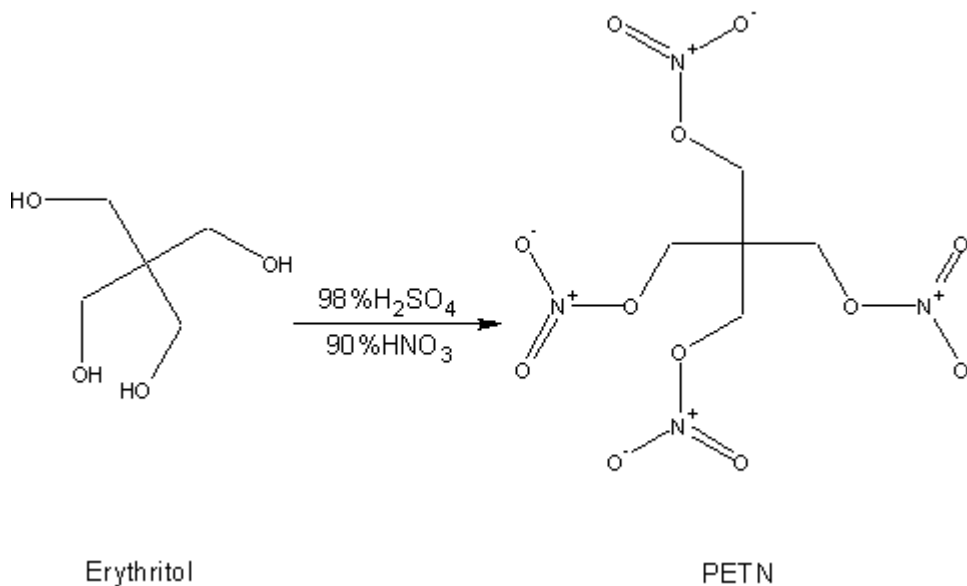

Reaction Equation

Hazards: Use extreme caution when handling 90% nitric acid. 90% Nitric acid is highly volatile, and emits highly poisonous fumes of nitrogen oxides. Wear gloves, proper lab clothing, and use maximum ventilation when handling. Wear gloves and proper clothing when handling 98% sulfuric acid. Acetone is highly flammable; avoid contact with flames, sparks, or electric discharges.

Procedure: Note: This procedure uses an excessive amount of 90% nitric acid to properly carryout the reaction. This excessive amount of acid can be recovered by treating the reaction mixture (after complete removal of the product) with methylene chloride to recover the nitric acid. Prior to this action, a small amount of sulfuric acid should be added to the reaction mixture. Afterwards, the reaction mixture should be extracted with several volumes of methylene chloride. These combined volumes can then be carefully distilled to recover the nitric acid of 99% purity (see nitric acid, 90% and 99% respectively).

Place 130 grams of 98% sulfuric acid into a suitable flask, and then place the flask into a cold-water bath. After which, gradually add 20 grams of pentaerythritol over a period sufficient to keep the sulfuric acid below 30 Celsius. During the addition, stir the sulfuric acid rapidly. Note: If the acids temperature gets above 30 or 40 Celsius, carbonization of the pentaerythritol may take place. After the addition of the pentaerythritol, place 120 grams of 90% nitric acid into a clean flask, and then place this flask into a hot water bath at 40 Celsius. Then, gradually add the sulfuric acid/pentaerythritol mixture over a period sufficient to keep the nitric acid at a temperature below 60 Celsius. During the addition, stir the nitric acid rapidly. After the addition, stir the reaction mixture rapidly for about 1 hour. Thereafter, stop stirring, and allow the reaction mixture to settle for a few minutes. Then, pour the entire reaction mixture into 1000 milliliters of ice-cold water. After which, filter-off the precipitated product, wash with several hundred milliliters of cold water, 200 milliliters of 10% sodium carbonate solution, and then with several hundred milliliters of cold water. Afterwards, vacuum dry or air-dry the product. Then, add and dissolve the dry product into 800 to 1000 milliliters of acetone, and then stir the solution for several minutes after filtering (to remove any insoluble impurities). Thereafter, add 2000 milliliters of ice-cold water, and stir the mixture for several minutes. After which time, filter-off the precipitated PETN product, wash with 500 milliliters of cold water, and then vacuum dry or air-dry the product.

Notes:

PETN blasting explosive

To a 500-milliliter beaker, place 100 grams of finely granulated PETN, 20 grams DNP, and 80 grams of TNT. Then heat the mixture to 90 Celsius. When the mixture is molten, rapidly stir the mixture for 1 hour. After 1 hour, pour the melt into any desirable, permanent container, and then allow the melt to solidify. After the melt has solidified, the primer explosive is ready to be used as a detonator for demolition charges, or explosive munitions. Requires blasting cap or detonation for initiation. Commercial & Industrial note: Part or parts of this laboratory process may be protected by international, and/or commercial/industrial processes. Before using this process to legally manufacture the mentioned explosive, with intent to sell, consult any protected commercial or industrial processes related to, similar to, or additional to, the process discussed in this procedure. This process may be used to legally prepare the mentioned explosive for laboratory, educational, or research purposes.

PETN bonded explosive charge

Into a beaker, place 146 grams PETN, 36 grams of polyethylene, and 18 grams dimethyl glycol phthalate. Then heat the beaker to 85 Celsius and manually blend the mixture for 1 hour until a dough-like, viscous, non-tacky homogeneous mass is produced. After 1 hour, remove the heat source, and then press the explosive dough into any desirable mold, container, bomb casing, or warhead casing and then cure for several days. The dough can also be kneaded into sheets and then cut into strips (allow the strips to cure for several days). For demolitions use, remove the explosive from the mold or container after curing and then wrap in plastic, paper or cardboard. Requires blasting cap or detonator for initiation. Commercial & Industrial note: Part or parts of this laboratory process may be protected by international, and/or commercial/industrial processes. Before using this process to legally manufacture the mentioned explosive, with intent to sell, consult any protected commercial or industrial processes related to, similar to, or additional to, the process discussed in this procedure. This process may be used to legally prepare the mentioned explosive for laboratory, educational, or research purposes.

PETN propellant charge

Into a beaker place 84 grams of PETN, 84 grams of nitroguanidine, 24 grams of triphenyl phosphate, 128 grams of ammonium perchlorate, and then 100 milliliters of dry kerosene. Then rapidly blend the mixture for several hours until a fine unified mixture is obtained. Thereafter, press the propellant into any desired rocket motor or mold, and then cure for several days at room temperature. Remember, the mold should be the same shape and size as the desired rocket motor. Do not use a blasting cap or detonator for initiation. Commercial & Industrial note: Part or parts of this laboratory process may be protected by international, and/or commercial/industrial processes. Before using this process to legally manufacture the mentioned explosive, with intent to sell, consult any protected commercial or industrial processes related to, similar to, or additional to, the process discussed in this procedure. This process may be used to legally prepare the mentioned explosive for laboratory, educational, or research purposes.

“Pentolite” PETN explosive composition

Into a beaker, place 100 grams of TNT, and then 120 grams of water. Thereafter, heat the mixture to about 80 Celsius until the TNT melts. When the TNT has melted, carefully, and slowly add 1064 grams of PETN, and then 2 grams of calcium carbonate. During the addition, rapidly stir the molten TNT mixture. After the addition, continue to stir the molten mixture for about 2 minutes, and then add 120 milliliters of cold water to the mixture. The addition of the water will cause granulation of the pentolite. After the addition of the water, filter-off the granules of pentolite while the mixture is still hot. After which, place the granules onto a shallow pan, and allow them to air-dry. Thereafter, the dry granules may be pressed into any desirable explosives body. Pentolite should not be used in artillery shells, mortar bombs, or any high-speed projectile. Pentolite is well suited as the main explosive in grenades, land mines, booby-trap devices, and in the making of boosters. Pentolite may be powdered, and used in detonating cords. Requires blasting cap or detonator for initiation. Commercial & Industrial note: Part or parts of this laboratory process may be protected by international, and/or commercial/industrial processes. Before using this process to legally manufacture the mentioned explosive, with intent to sell, consult any protected commercial or industrial processes related to, similar to, or additional to, the process discussed in this procedure. This process may be used to legally prepare the mentioned explosive for laboratory, educational, or research purposes.

Standard Explosives “Semtex” PETN explosive composition

Into a blender equipped with plastic stir blade, place 1000 grams of RDX, and then add 10 grams of calcium carbonate, followed by 100 grams of polypropylene glycol. Thereafter, begin rapidly stirring the mixture, and rapidly blend the mixture for 2 hours at room temperature. After 2 hours of blending, slowly add 660 grams of PETN, while continuing to rapidly blend the mixture. After the addition, continue to stir the mixture for about 3 hours, and thereafter, place the doughy mixture into a sheet press-extruding machine, and extrude the explosive through an opening 10 millimeters thick, by 100 centimeters long (thickness, and width may vary) into 1 meter length sheets, under high pressure. Then cut the 1-meter length sheets into ten 100-millimeter length sheets. Note: Larger sheets may be cut if desired. The idea here is to prepare sheets of this semtex composition so they can be pressed into munitions, or used as sheet explosives for demolitions use. For demolitions use, the sheets should be at least 10 millimeters thick, by 30 centimeters by 30 centimeters. For munitions, such as shells, or land mines, it should be folded over and over, and pressed there into under high pressure. Semtex should not be used in supersonic projectiles. Requires blasting cap or detonator for initiation.

PETN explosive munitions

Detonating cord is commonly used by militaries to detonate bodies of high explosives during field operations. The detonating cord is simply wrapped and tied around the explosive bodies which are usually blocks of explosive, such as, C4, composition B, TNT, or any other type of demolition explosive. The detonating cord comes in long spools containing up to several thousand feet of detonating cord per roll. The detonating cord can be wrapped and tied around multiple bodies of explosives depending on your knowledge of wrapping and tying detonating cord. Various military manuals explain the proper way of wrapping and tying detonating cord around explosive bodies for military demolition operations. The advantages of detonating cord include, (1) multiple blasting caps are not required for detonating many explosive bodies located in different places, and (2) large chains of explosives all connected by a single strand of detonating cord can be detonated with a single blasting cap, which is used to initiate the detonating cord. When a blasting cap initiates the detonating cord, the center core of PETN detonates and propagates forwards at a speed of about 7500 meters per second. From point A to point B the detonation of the detonating cord produces a small yet powerful pressure wave, which provides the necessary energy to initiate any block, or blocks of high explosive. In essence, detonating cord is like a long, continuous and flexible blasting cap. Working example, in one US Army field exercise, over 1000 pounds of high explosive, separated into 1000, 1 pound blocks, and spread out over an area 10 miles long, was detonated using a continues strand of detonating cord. It took less then 3 seconds for all the explosives to be detonated over the 10-mile long area.

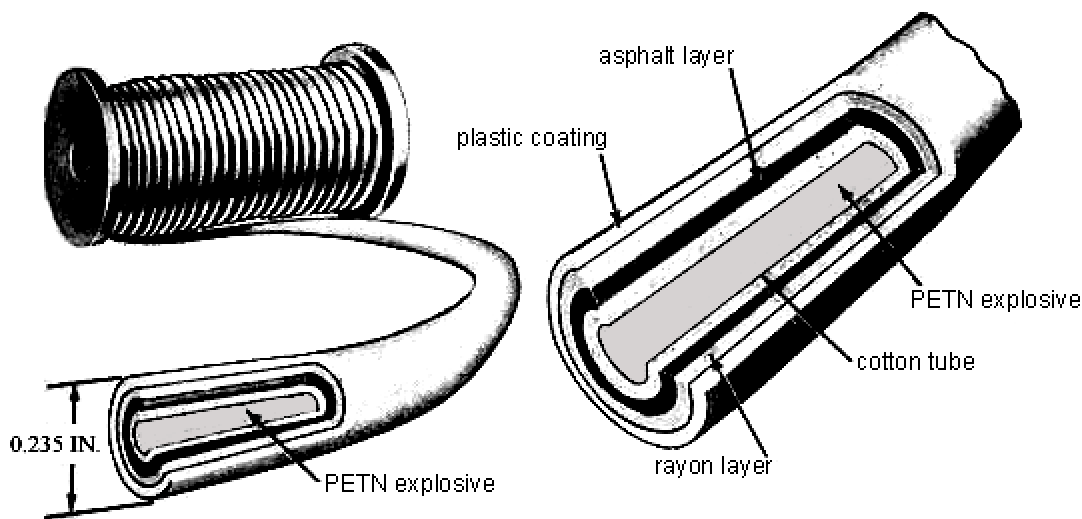
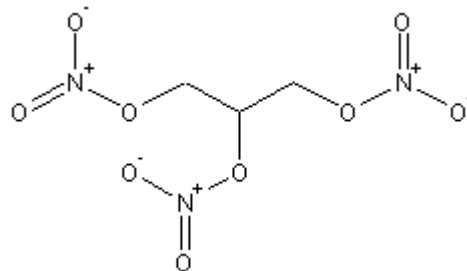

Figure 060. Standard detonating cord. See TM 43-0001-38 for additional information.

13-06. NQ. Nitroglycerine

CHAPTER 13: THE PREPERATION OF NITRATE ESTERS



NQ

Nitroglycerine is a pale yellow, oily liquid, which explodes on rapid heating or on percussion—nitroglycerine still requires a primary explosive for initiation under most conditions. Nitroglycerine begins to decompose when heated to about 50 Celsius—where upon reddish fumes develop, and shortly thereafter it may detonate. The pure liquid becomes volatile when gently heated to 100 Celsius, but will decompose if rapidly heated to 50+ Celsius with evolution of reddish fumes followed by explosion. Nitroglycerine detonates when gently heated to 218 Celsius—producing a violent flash and loud bang. It is insoluble in water, but miscible with acetone, ether, benzene, ethyl acetate, and chloroform. Pure nitroglycerine can safely be stored in a refrigerator, and protected from light. For prolonged storage, it is best to store nitroglycerine in an inert solvent such as acetone—whereby the nitroglycerine can be separated as an oily insoluble layer upon the addition of cold water. Nitroglycerine is widely used in propellant compositions for smokeless gunpowders, high performance rocket compositions, and high performance gun propellants. Nitroglycerine is also commonly used in dynamites when mixed with inert fillers. The use of nitroglycerine in explosives has decreased due to several main factors: 1) its difficult to handle in the since that it causes severe headaches, 2) it's stability has been in question as the result of several accidents—however these accidents where the result of poor conditions, and 3) its explosive power is quite high, and this results in tendency to cause cave-ins and unsatisfactory rock fracturing; as a result, its use in mining operations and engineering projects has been decreased. Note: Ammonium nitrate has replaced nitroglycerine in most mining explosives due to lesser power, and more convenient methods of handling and storage. In any regards, nitroglycerine is still a cheap and readily available material for use in military, or commercial explosives.

Molecular weight: 227.085	Flammability: Non flammable—detonates at 50+ Celsius
Detonating velocity: 7700	Toxicity: High (causes severe headaches—use proper ventilation, and avoid inhalation or skin contact)
Sensitivity: Moderate	Classification: Secondary explosive
Stability: Moderate	Overall value (as secondary explosive): Extremely high

Procedure 13-06A: Preparation of NQ

Materials:	1. 118 grams 90% nitric acid
	2. 128 grams 98% sulfuric acid
	3. 40 grams glycerol
	4. 50 grams of anhydrous magnesium sulfate
	5. 500 milliliters of a 5% sodium bicarbonate solution

Summary: Nitroglycerine is prepared by the nitration of glycerol with a mixture of sulfuric and nitric acids. After the reaction, the reaction mixture is added to ice, the product layer is removed, washed, and then dried.

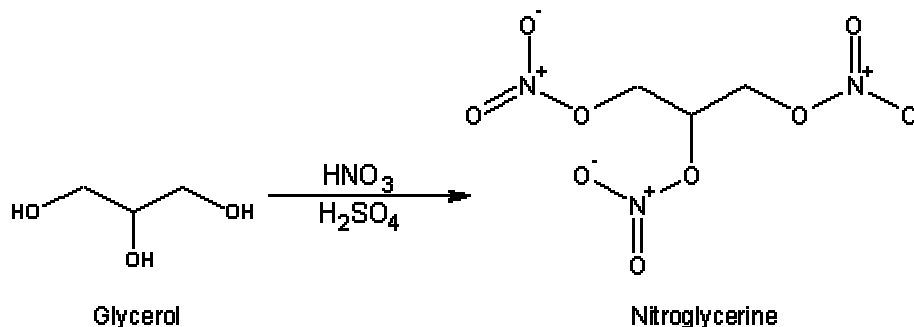

CHAPTER 13: THE PREPERATION OF NITRATE ESTERS
Reaction Equation

Hazards: Wear gloves when handling 90% nitric acid, which is highly toxic, and evolves toxic and corrosive fumes of nitrogen oxides—use great care. Use caution when handling 98% sulfuric acid, which can cause severe skin burns. Although nitroglycerine is stable when kept at a temperature below 40 Celsius, always use caution when handling nitroglycerine. Nitroglycerine can safely be prepared as long as care is taken into consideration. Always make nitroglycerine in small quantities only, and store nitroglycerin in refrigerators away from direct sunlight. When using nitroglycerine to make explosives, always dilute it with an inert absorbent such as diatomaceous earth. Note: inhalation of nitroglycerine vapors, or skin absorption may lead to powerful headaches. In some cases these headaches may last for up to 7 or 8 days. Use great care as to avoid inhalation or skin absorption of nitroglycerine vapors.

Procedure: Prepare a nitrating acid mixture by adding 128 grams of 98% sulfuric acid into 118 grams of 90% nitric acid, and then cool the acid mixture to 10 Celsius by means of an ice water bath. Then begin stirring the acid mixture. While stirring the acid mixture, slowly add drop wise, 40 grams of glycerol over a period sufficient to keep the nitrating acid mixture at 10 Celsius. After addition of the glycerol, stir the reaction mixture for 2 hours while keeping the temperature at 10 Celsius. After stirring for 2 hours, gently pour the reaction mixture onto 1000 grams of ice (note: use care as sulfuric acid generates excessive heat when applied to water or ice—monitor the temperature as the reaction mixture is poured onto to the ice—excessive heat buildup can result in violent decomposition of the nitroglycerine) contained in a suitable beaker or vessel, and then allow the entire mixture to stand for 1 hour. Then pour the entire mixture into a seperatory funnel, and then remove the upper nitroglycerine layer. Then wash this nitroglycerine layer by mixing it with 500 milliliters of a 5% sodium bicarbonate solution, and then place this entire mixture into a clean seperatory funnel, and remove the lower nitroglycerine layer (in some cases the nitroglycerine will be the upper layer). Then wash the nitroglycerine layer with 500 milliliters of ice-cold water, and then place the mixture into a clean seperatory funnel, and then remove the lower nitroglycerine layer. Finally, add to the nitroglycerine layer, 50 grams of anhydrous magnesium sulfate (to absorb water), and then stir for several minutes, then filter-off the magnesium sulfate, and then place the nitroglycerine into an amber glass bottle and store in a refrigerator until use.

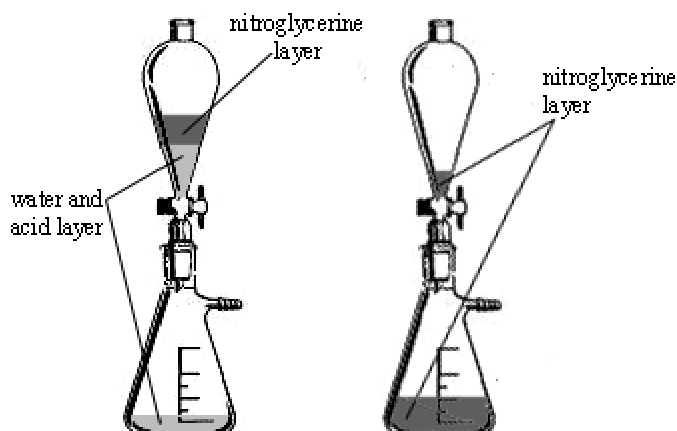

Figure 061. Set-up for decanting nitroglycerine. Left illustration: removing the water and/or acid layer. Right illustration: collecting the nitroglycerine (make sure the apparatus does not tip over).

Notes:

“HESP” High-energy smokeless powder (military grade; double based)

Thoroughly mix 4 grams of lead beta-resorcylate, 4 grams of lead salicylate, and 400 milligrams of carbon black for 30 minutes, and then heat the mixture for 20 hours at 110 Celsius. Then mix this dry blend with 9 grams of di-n-propyladipate, and then manually blend for 30 minutes until a stiff paste forms. Now, prepare a liquid casting solvent by mixing 10 grams of polyglycol adipate-tolylene 2,4-diisocyanate, 56 grams of nitroglycerin and 600 milligrams of 2-nitrodiphenylamine, and then manually blend this mixture for 30 minutes. Afterwards, add this blend to the paste, and then lower the temperature of the mixture to 49 Celsius and thoroughly mix for 30 minutes. After 30 minutes, add 10 grams of polyglycol adipate-tolylene 2,4-

CHAPTER 13: THE PREPERATION OF NITRATE ESTERS

diisocyanate, 56 grams of nitroglycerin, 600 milligrams of 2-nitrodiphenylamine, and then 20 grams of HMX. After which, manually blend the mixture for 30 minutes. Then add 29 grams of nitrocellulose, and continue mixing for about 90 minutes. After 90 minutes, cast the slurry into any desirable mold or container, and then cure (dry) in an oven at 60 Celsius for several days. After several days, remove the propellant from the mold or container and then granulize the propellant by ball milling. Do not use a blasting cap or detonator for initiation; use only a standard bullet primer. Commercial & Industrial note: Part or parts of this laboratory process may be protected by international, and/or commercial/industrial processes. Before using this process to legally manufacture the mentioned explosive, with intent to sell, consult any protected commercial or industrial processes related to, similar to, or additional to, the process discussed in this procedure. This process may be used to legally prepare the mentioned explosive for laboratory, educational, or research purposes.

“Dynamite” Nitroglycerine blasting agent

Into a beaker, add 49 grams of diatomaceous earth, and 1 gram of sodium carbonate. Then, manually and thoroughly blend the mixture for 1 hour. After 1 hour, carefully and slowly add 150 grams of nitroglycerine over a period of 1 hour while manually blending the diatomaceous earth mixture. After addition of the nitroglycerine, manually and thoroughly blend the mixture for 1 hour. After blending for 1 hour, gently press the mixture into any desirable permanent container made of cardboard or thin walled plastic tubes. Then seal both ends of the tube. If using a plastic tube, a blasting cap hole will have to be drilled into one of the tubes end caps. Seal the cardboard tubes at both ends with cardboard or paper, and then grease. The cardboard or paper should be thin enough to accommodate a blasting cap hole, which can easily be made by puncturing a hole in the cardboard or paper. For demolitions purposes, the tubes should be 1 to 2 inches wide by 5 to 11 inches long. Dynamite can be used in warfare to injure or kill troops by gently pressing the dynamite into steel pipes and then sealing both ends. If steel is used, a blasting cap hole will have to be drilled in one of the pipes end caps. The steel pipe should be 1 inch wide by 5 to 6 inches long to produce a casualty radius of 15 meters upon detonation. Dynamite requires a blasting cap or detonator for initiation.

13-07. Nitro starch. Nitrated cornstarch

Nitro starch forms an orange colored powder, which is highly flammable. It has a average nitrogen content of 16.5%. It is soluble in a mixture of 95% ethanol and 99% diethyl ether (ratio of 1 to 1). When dry, it is easily ignited and explodes when mixed with oxidizers and reducing agents. Overall, the properties of nitro starch are similar to nitrocellulose. The dry compound should never be stored dry, but should be stored wet with 10% water of alcohol. Nitro starch is used successfully as a substitute for nitrocellulose in smokeless gunpowders, rocket propellants, fireworks, and blasting compositions when mixed with sodium or potassium nitrate, TNT, RDX, ammonium nitrate, or perchlorates.

Molecular weight: Uncalculated	Flammability: Highly flammable (deflagrates)
Detonating velocity: Similar to nitrocellulose	Toxicity: Low
Sensitivity: Moderate	Classification: Secondary explosive
Stability: Good	Overall value (as secondary explosive): High

Procedure 13-07A: Preparation of Nitro starch (average nitrogen content)

Materials:	1. 224 grams 99% nitric acid
	2. 890 grams 98% sulfuric acid
	3. 21.4 grams cornstarch
	4. 448 grams 55% nitric acid
	5. 1000 milliliters of 1% ammonia solution

Summary: Nitro starch is prepared by the nitration of cornstarch with a strong nitrating acid. The product is then collected by filtration, washed and then dried. Commercial & Industrial note: For related, or similar information, see Serial No. 675,819, August 2nd, 1957, by Vsevoid A. Amoretty, New York, NY, to Ignace A. Grageroff, New York, NY. Part or parts of this laboratory process may be protected by international, and/or commercial/industrial processes. Before using this process to legally manufacture the mentioned explosive, with intent to sell, consult any protected commercial or industrial processes related to, similar to, or additional to, the process discussed in this procedure. This process may be used to legally prepare the mentioned explosive for laboratory, educational, or research purposes.

No reaction Equation.

Hazards: Warning! Wear gloves and use proper ventilation when handling 99% nitric acid. 99% nitric acid is a highly poisonous and corrosive liquid, which evolves poisonous fumes of nitrogen oxides. Handle with great care. Wear gloves when handling 98% sulfuric and 55% nitric acid, which can both cause severe skin burns.

Procedure: Note: This procedure uses an excessive amount of 99% nitric acid to properly carryout the reaction. This excessive amount of acid can be recovered by treating the reaction mixture (after complete removal of the product) with methylene chloride to recover the nitric acid. Prior to this action, a small amount of sulfuric acid should be added to the reaction mixture. Afterwards, the reaction mixture should be extracted with several volumes of methylene chloride. These combined volumes can then be carefully distilled to recover the nitric acid of 99% purity (see nitric acid, 90% and 99% respectively).

Place 448 grams of 55% nitric acid into a beaker, and cool to -5 Celsius by means of an ice/salt bath. Then Slowly add 21.4 grams of finely divided dry cornstarch while stirring and maintaining the 55% nitric acid at -5 Celsius. Next, prepare a nitrating acid mixture by carefully adding 890 grams of 98% sulfuric acid into 224 grams of 99% nitric acid. Then slowly add this nitrating acid to the 55% nitric acid/cornstarch mixture while stirring the 55% nitric acid/cornstarch mixture, and maintain its temperature at -5 Celsius. After the addition of the nitrating acid, remove the ice/salt bath, and then pour the entire reaction mixture into 1500 milliliters of ice-cold water. Then stir the ice-cold water for 30 minutes. After which, filter-off the precipitated product, wash with 1000 milliliters of 1% ammonia solution, and then with 1500 milliliters of hot water. After washing, dry the nitro starch product in an oven at 70 Celsius for 1 hour or until dry, or vacuum dry the product.

Notes:

Nitrostarch explosive composition

Into a mixing blender, place 100 grams of ammonium perchlorate, 80 grams of nitrostarch, 20 grams of aluminum powder, and then 10 grams of diesel fuel. Thereafter, thoroughly blend the mixture for several hours to form a uniform mixture. During the blending operation, try to keep the evaporation of the diesel fuel to a minimum. Thereafter, press the mixture into any desirable bombshell, artillery shell, or mortar shell under high pressure. For demolitions work, pack the explosive into wax coated cardboard tubes (sealed at both ends), under pressure. The cardboard tubes should be about 2 inches wide, by 6 inches long. After pressing the explosive into the desirable shell, or cardboard tubes, cure the mixture for several days in a warm room before use. Requires blasting cap or detonator for initiation; preferably a TNT booster pellet (about 20 grams per 210 grams of explosive) should be placed at the side of the mixture, and the blasting cap attached there to. Commercial & Industrial note: Part or parts of this laboratory process may be protected by international, and/or commercial/industrial processes. Before using this process to legally manufacture the mentioned explosive, with intent to sell, consult any protected commercial or industrial processes related to, similar to, or additional to, the process discussed in this procedure. This process may be used to legally prepare the mentioned explosive for laboratory, educational, or research purposes.

13-08. EGDN. *Ethylene glycol dinitrate*

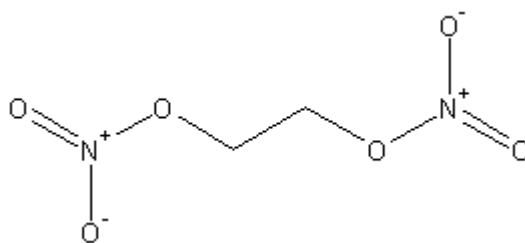

EGDN forms a colorless, oily, syrupy liquid with a melting point of -22.8 Celsius. It detonates when heated to over 70 Celsius. The liquid is insoluble in water, but readily soluble in alcohol and ether. EGDN like nitroglycerine should be handled with care and inhalation and skin absorption of the liquid or vapor should be avoided at all costs—cause severe headaches/migraines. The liquid is widely used when admixed with nitroglycerine for cold weather resistant dynamites and blasting compositions, It can be slurried with nitrocellulose, nitro starch, and other secondary explosives for use in blasting dynamites. EGDN is also used in place of nitroglycerine or in combination with for the production of high performance gun propellants. The pure liquid should be stored in amber glass bottles in a refrigerator until use.

Molecular weight: 152.063	Flammability: Flammable and may detonate on ignition
Detonating velocity: Similar to nitroglycerine	Toxicity: High (causes headaches)

Sensitivity: Low	Classification: Secondary explosive
Stability: Good	Overall value (as secondary explosive): Moderate

Procedure 13-08A: Preparation of EGDN

Materials:	1. 90 milliliters of 90% nitric acid
	2. 130 milliliters of 98% sulfuric acid
	3. 60 milliliters of ethylene glycol
	4. 500 milliliters of a 5% sodium carbonate solution
	5. 50 grams of anhydrous sodium sulfate

Summary: EGDN is readily prepared by mixing a nitric and sulfuric acid mixture with propylene glycol. The nitrated compound forms quite readily and is easily recovered by drowning the entire reaction mixture into cold water, followed by separating the EGDN layer, washing, and then drying.

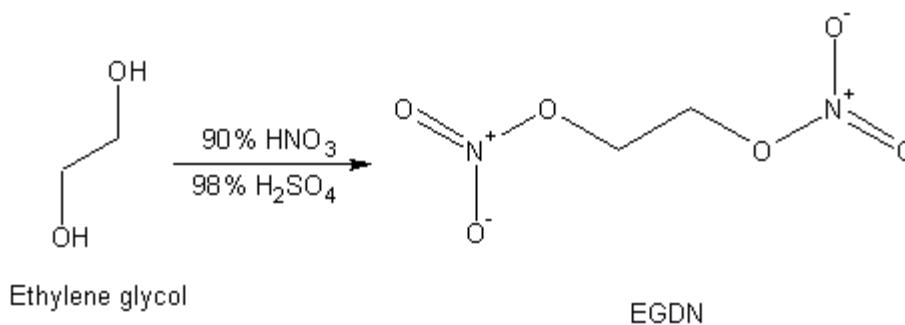

Hazards: 90% nitric acid is a fuming corrosive acid, which evolves toxic and corrosive fumes. Use maximum ventilation when handling and avoid skin contact and inhalation. Use the standard procedure when handling concentrated sulfuric acid, as it causes severe burns.

Procedure: Into a suitable flask, add 90 milliliters of 90% nitric acid, followed by carefully adding 130 milliliters of 98% sulfuric acid. After the addition of both acids, place the acid mixture into an ice bath, and chill to 10 Celsius. When the acid mixture temperature reaches about 10 Celsius, slowly add drop wise, 60 milliliters of ethylene glycol while stirring the acid mixture and maintaining its temperature around 10 Celsius at all times. After the addition of the ethylene glycol, continue to stir the reaction mixture for 1 hour at 10 Celsius. After 1 hour, slowly pour the reaction mixture onto 1000 grams of ice (note: use care as sulfuric acid generates excessive heat when applied to water or ice—monitor the temperature as the reaction mixture is poured onto to the ice—excessive heat buildup can result in violent decomposition of the EGDN) contained in a suitable beaker or vessel, and then allow the total mixture to stand for about 1 hour. Thereafter, pour the reaction mixture into a separatory funnel, and allow it to stand for 15 minutes—two layers will result. Shortly afterwards, remove the lower acid layer, and then pour out the upper layer (composed of EGDN), and then place this upper layer into a clean beaker, and then add in 500 milliliters of a 5% sodium carbonate solution (to remove traces of acid). Thereafter, pour the entire mixture back into a clean separatory funnel, and then remove the lower EGDN layer (note in some cases the EGDN layer will be the upper layer). After removing the lower product layer (or upper product layer), place the EGDN layer into a clean beaker, and then add in 500 milliliters of cold water, and then place this mixture into a clean separatory funnel, and remove the lower EGDN layer. Finally, add in 50 grams of anhydrous sodium sulfate to the EGDN layer, and then stir the entire mixture for several minutes. Afterwards, filter-off the sodium sulfate, and then place the EGDN into an amber glass bottle, and store in a refrigerator until use.

Notes:

13-09. Metriol. 2-methyl-3-(nitrooxy)-2-[(nitrooxy)methyl]propyl nitrate

CHAPTER 13: THE PREPERATION OF NITRATE ESTERS

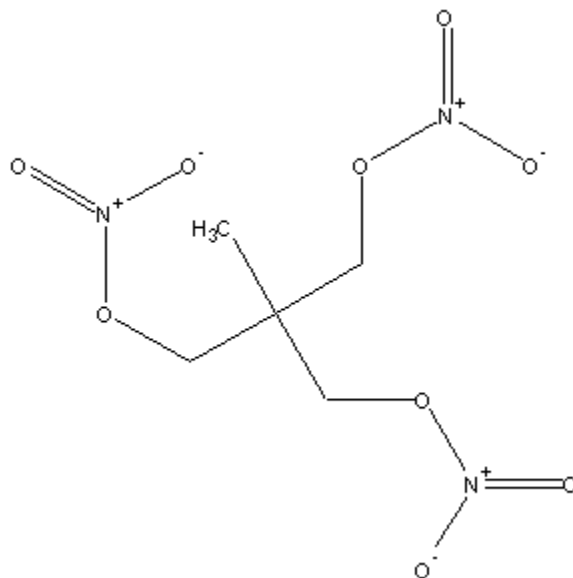

Metriol

Metriol forms a colorless to yellowish, oily, viscous liquid resembling nitroglycerine, but with a melting point of -4 Celsius and much greater stability than nitroglycerine. The oily liquid begins to decompose when heated to 180 Celsius, with evolution of nitrous fumes—detonation may shortly result thereafter. Metriol is much more stable than nitroglycerine, and is an effective substitute for nitroglycerine in high performance gun propellants, and rocket propellants—both when mixed with nitrocellulose, nitro starch, or HMX. It can also be used as a substitute for nitroglycerine in dynamites when mixed with EGDN, and small amounts of sodium nitrate, sodium carbonate, and propylene glycol. Metriol can also be slurried with RDX, TNT, and HMX and small amounts of nitrocellulose for use in blasting charges. It can also act as mild high-energy plasticizer for use in making flexible sheet explosives with RDX. Metriol should be stored in amber glass bottles in a refrigerator until use.

Molecular weight: 255.140	Flammability: Generally nonflammable but may detonate on strong ignition
Detonating velocity: Similar to nitroglycerine	Toxicity: High (causes headaches—less mild than nitroglycerine)
Sensitivity: Moderate	Classification: Secondary explosive
Stability: Good	Overall value (as secondary explosive): Moderate

Procedure 13-09A: Preparation of Metriol

Materials:	1. 112 milliliters of 90% nitric acid
	2. 45 milliliters of 98% sulfuric acid
	3. 12 grams of 2-(hydroxymethyl)-2-methylpropane-1,3-diol (also commonly called metriol—a common derivative with similar properties to pentaerythritol).
	4. 100 milliliters of diethyl ether
	5. 50 milliliters of a 5% sodium carbonate solution
	6. 10 grams of anhydrous sodium sulfate

Summary: Metriol is conveniently prepared by reacting 2-(hydroxymethyl)-2-methylpropane-1,3-diol with 90% nitric acid in the presence of concentrated sulfuric acid. The reaction is generally brief, and the resulting mixture is then treated with ice, and allowed to stand. The next day, the mixture is mixed with diethyl ether to dissolve the oily product, and this resulting ether mixture is then washed, dried, and then evaporated to remove the ether and recover the oily product.

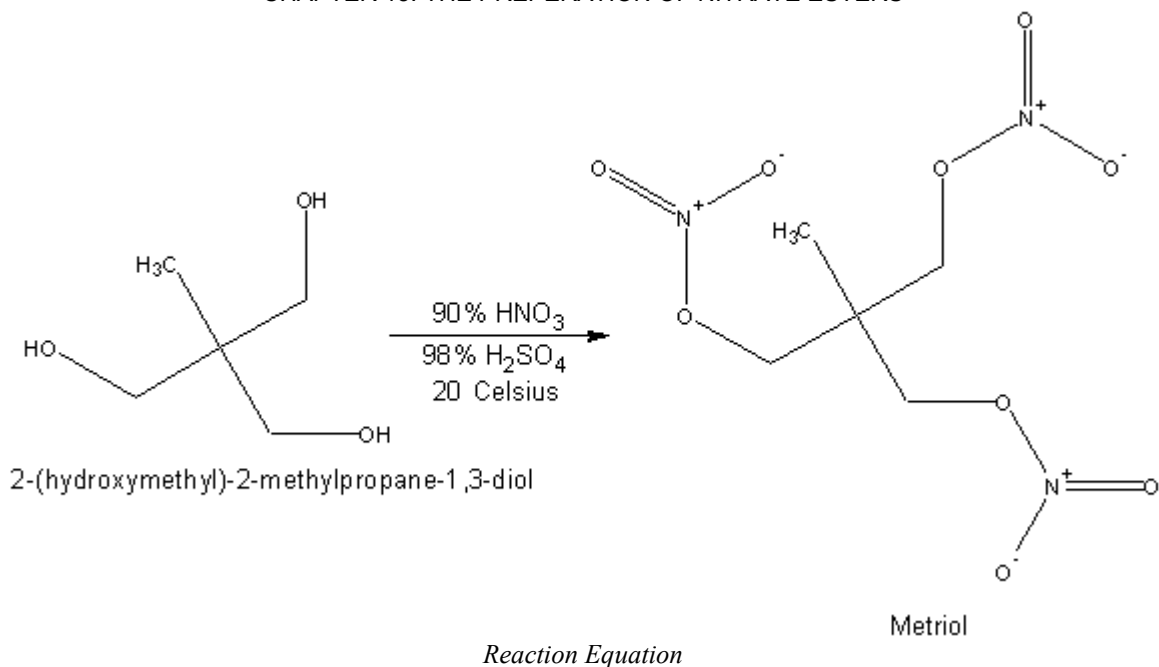

Hazards: Use care when handling 90% nitric acid, which is highly toxic and corrosive and evolves corrosive and toxic fumes of nitrogen oxides—use maximum ventilation. Use care when handling concentrated sulfuric acid, which can cause skin burns.

Procedure: Note: This procedure uses an excessive amount of 90% nitric acid to properly carryout the reaction. This excessive amount of acid can be recovered by treating the reaction mixture (after removal of the ether layer) with methylene chloride to recover the un-used nitric acid. The reaction mixture should be extracted with several volumes of methylene chloride. These combined volumes can then be carefully distilled to recover the nitric acid of 99% purity (see nitric acid, 90% and 99% respectively).

Into a suitable flask equipped with a thermometer, motorized stirrer, and a funnel, place 112 milliliters of 90% nitric acid, followed by carefully adding 45 milliliters of 98% sulfuric acid. Thereafter place this flask into a cold-water bath and then chill to 20 Celsius. Then slowly add (in small portions), 12 grams of 2-(hydroxymethyl)-2-methylpropane-1,3-diol over a period of about 30 minutes while rapidly stirring the nitric acid/sulfuric acid mixture and maintaining its temperature below 25 celsius. After the addition of the 2-(hydroxymethyl)-2-methylpropane-1,3-diol, continue to rapidly stir the reaction mixture for 1 hour at a temperature below 25 celsius. Afterwards, remove the cold-water bath, and then add in 500 grams of crushed ice, and then stir the mixture for 12 hours. Thereafter, mix in 100 milliliters of diethyl ether, and then rapidly stir the entire mixture for 2 hours at room temperature. Then place the entire mixture into a large seperatory funnel, and remove the upper ether layer (after removing the lower acid and water layer), and then place this upper ether layer into a clean beaker, and then add in 50 milliliters of a 5% sodium carbonate solution, and stir the mixture for 10 minutes. Then place this mixture into a clean seperatory funnel, and then remove the upper ether layer. Immediately thereafter, place this ether layer into a clean beaker, and then add in 250 milliliters of cold water and then stir the whole mixture for 10 minutes. Then place this mixture into another clean seperatory funnel, and then once again, remove the upper ether layer. Finally, add 10 grams of anhydrous sodium sulfate to this ether layer, and stir briefly for about several minutes. Then filter-off the sodium sulfate, and then place this filtered ether mixture into a distillation apparatus or vacuum distillation apparatus, and remove the ether under mild heat until no more ether passes over. When no more ether passes over, stop the distillation and/or evaporation, and remove the oily liquid product, and then store it in amber glass bottles in a refrigerator until use.

Notes:

13-10. Nitropropylene. PGDN. *Propylene glycol dinitrate*

CHAPTER 13: THE PREPERATION OF NITRATE ESTERS

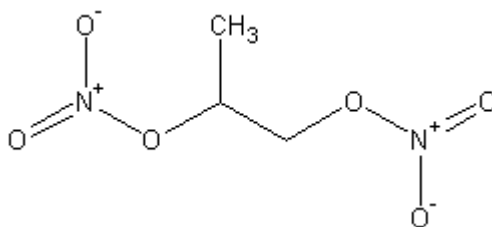

PGDN

PGDN is a moderately stable, yellowish to yellowish water white, oily, viscous liquid, with a melting point of -23 celsius. It tends to explode when heated, and cannot be distilled even under high vacuum without any decomposition—the liquid may detonate if ignited. PGDN is a common liquid explosive of the nitroglycerine type, with properties resembling EGDN, and nitroglycerine. It is widely used in nitroglycerine dynamites to lower freezing point, and it is used extensively in the preparation of high performance gun propellants with nitrocellulose or nitro starch, and rocket propellants in combination with nitrates, perchlorates, or secondary explosives like HMX, and inert fillers. The pure liquid should be stored in amber glass bottles in a refrigerator away from light until use.

Molecular weight: 166.090	Flammability: Flammable—detonates on ignition
Detonating velocity: Similar to nitroglycerine	Toxicity: High (causes headaches)
Sensitivity: Moderate	Classification: Secondary explosive
Stability: Moderate	Overall value (as secondary explosive): High

Procedure 13-10A: Preparation of PGDN

Materials:	1. 90 milliliters of 90% nitric acid
	2. 102 milliliters of 98% sulfuric acid
	3. 60 milliliters of propylene glycol
	4. 500 milliliters of a 5% sodium carbonate solution
	6. 50 grams of anhydrous sodium sulfate

Summary: PGDN is easily prepared by nitrating propylene glycol with 90% nitric acid in the presence of concentrated sulfuric acid. The reaction is generally mild, and afterwards, the reaction mixture is gently poured onto ice, the product layer is then removed, washed, and then dried.

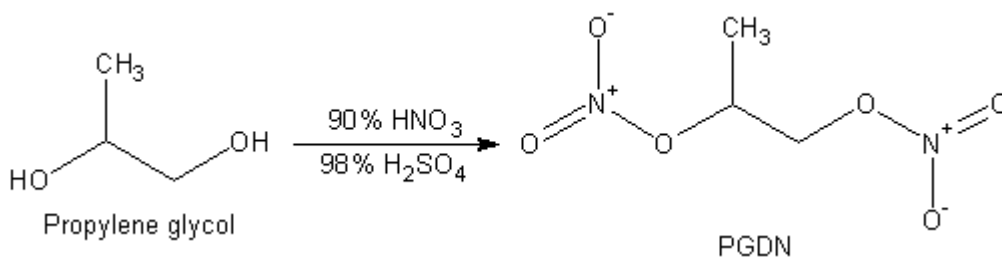
Reaction Equation

Hazards: Use care when handling 90% nitric acid, which is highly toxic and corrosive and evolves corrosive and toxic fumes of nitrogen oxides—use maximum ventilation. Use care when handling concentrated sulfuric acid, which can cause skin burns.

Procedure: Into a suitable flask equipped with a motorized stirrer, thermometer, and addition funnel, place 90 milliliters of 90% nitric acid, followed by carefully adding 102 milliliters of 98% sulfuric acid. Thereafter, place this acid mixture into an ice bath, and chill to 5 Celsius. Thereafter, place 60 milliliters of propylene glycol (may need to be gently warmed before adding—pure propylene glycol is a viscous oily liquid that tends to solidify on standing), into the addition funnel, and then add the propylene glycol drop-wise, over a period of 2 hours, to the acid mixture, while stirring the acid mixture and maintaining its temperature below 10 celsius. Note: during the reaction, red fumes will develop most of the time. If this is the case, don't worry, nothing is going to blow up!). After the addition of the propylene glycol, continue to stir the reaction mixture for 1 hour at a temperature below 10 Celsius. Thereafter, slowly pour the entire reaction mixture (even if two layers exist), onto 1000 grams of ice contained in a suitable beaker or vessel (note: use care as sulfuric acid generates excessive heat when applied to water or ice—monitor the temperature as the reaction mixture is poured onto to the ice—excessive heat buildup can result in

CHAPTER 13: THE PREPERATION OF NITRATE ESTERS

violent decomposition of the PGDN), and then allow the whole mixture to stand until the ice has fully melted (if it has not already done so). Thereafter, place the whole mixture into a seperatory funnel, and then remove the upper product layer (after removing the lower acid layer). Afterwards, wash the upper product layer (by simply mixing with) 500 milliliters of a 5% sodium carbonate solution, and then place the entire mixture into a clean seperatory funnel, and remove the lower PGDN layer (note: in some cases the PGDN will be the upper layer). Thereafter, wash the this PGDN layer once more with 500 milliliters of ice water, and then pour this whole mixture into a clean seperatory funnel, and remove the lower PGDN layer once more. Finally, add 50 grams of anhydrous sodium sulfata into this PGDN layer, and then gently mix for several minutes. Then filter-off the sodium sulfata, and then store the PGDN into an amber glass bottle with the cap placed on but only loosely screwed on, and place this into a desiccator for 48 hours. After 48 hours, remove the bottle containing the PGDN, and place into a refrigerator until use.

Notes:

CHAPTER 14: THE PREPARATION OF POLYHYDRIC NITRATE ESTERS

HEXANITRATE, QUEBRACHITOL NITRATE, INOSITOL HEXANITRATE, MGP, MON, MX. PVN

14-01. Hexanitrate. *Sorbitol hexanitrate*

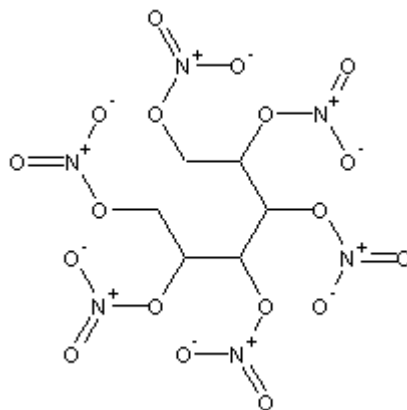

Hexanitrate

Hexanitrate forms white, or slightly colored crystals with a melting point of 55 Celsius. The crystals are readily soluble in 95% ethanol, but are relatively insoluble in water. It has excellent properties with a high degree of stability, and can be alloyed with TNT, or other low melting secondary explosives for use in filling shells, and bombs. Hexanitrate is also used in making smokeless powders in combination with nitrocellulose, nitro starch, and/or nitroglycerine.

Molecular weight: 452.154	Flammability: Generally nonflammable, but may flash on ignition
Detonating velocity: Similar to PETN	Toxicity: Moderate
Sensitivity: Low	Classification: Secondary explosive
Stability: Good	Overall value (as secondary explosive): High

Procedure 14-01A: Preparation of Hexanitrate

Materials:	1. 104 grams of 99% nitric acid
	2. 136 grams 98% sulfuric acid
	3. 50 grams sorbitol
	4. 1600 milliliters of 95% ethanol.
	5. 200 milliliters of 10% sodium carbonate solution

Summary: Sorbitol hexantrate is easily prepared by nitrating sorbitol with mixed acid of nitric and sulfuric. After the reaction, the crude product is decanted, washed, and then dissolved in 95% ethanol. This mixture is then added to warm water, which causes the solid product to precipitate. The product is then recrystallized from fresh 95% ethanol for purification. Commercial & Industrial note: For related, or similar information, see Serial No. 310,926, March 18th, 1930, by E.I. Dupont de Nemours & Company, to Rank H. Bergeim, Leonia, NJ. Part or parts of this laboratory process may be protected by international, and/or commercial/industrial processes. Before using this process to legally manufacture the mentioned explosive, with intent to sell, consult any protected commercial or industrial processes related to, similar to, or additional to, the process discussed in this procedure. This process may be used to legally prepare the mentioned explosive for laboratory, educational, or research purposes.

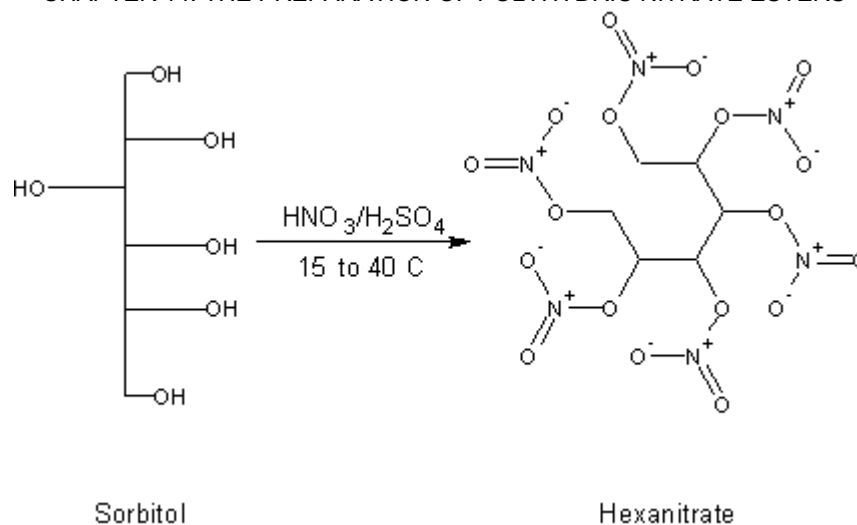
*Reaction Equation*

Hazards: Use extreme caution when handling 99% nitric acid. 99% Nitric acid is highly volatile, and emits highly poisonous fumes of nitrogen oxides. Wear gloves, proper lab clothing, and use maximum ventilation when handling. Wear gloves and proper clothing when handling 98% sulfuric acid

Procedure: Prepare a nitrating acid mixture by adding 104 grams of 99% nitric acid into a suitable flask, and then add 136 grams of 98% sulfuric acid. Then place this nitrating acid into a cold-water bath. Then, gradually add 50 grams of sorbitol over a period sufficient as to keep the reaction mixtures temperature below 50 Celsius. During the addition, rapidly stir the reaction mixture. Note: keep the temperature above 10 Celsius to prevent the nitrated sorbitol from becoming thick and gummy. After the addition, rapidly stir for about 30 minutes, and thereafter, stop the stirring and allow the reaction mixture to stand for about 20 minutes. Afterwards, decant the upper liquid layer, and then place in a clean beaker. After which, mix with several hundred milliliters of warm water, and stir for ten minutes. Then decant the upper liquid layer, and place it in a clean beaker. After which, mix with 200 milliliters of 10% sodium carbonate solution, and stir for ten minutes. Then remove the bottom liquid layer. Note: The product will be the upper layer if sulfuric acid is present. Then mix and dissolve the liquid product into 800 milliliters of 95% ethanol. Afterwards, filter the solution to remove any potential insoluble materials, and then add 1600 milliliters of warm water to the ethanol solution. The addition of the water will cause the product to precipitate. Allow the mixture to stand for 20 or 30 minutes to allow the product to fully separate. Then, filter-off the precipitated product, and then vacuum dry or air dry. Purification is then accomplished by dissolving this dry product into 800 milliliters of fresh 95% ethanol, followed by recrystallization. After the recrystallization process, wash the product with 200 milliliters of warm water, and then vacuum dry or air-dry the product. **Note:** Instead of dissolving the liquid product into 800 milliliters of 95% ethanol (as discussed after the 10% sodium carbonate washing), it can be washed with cold water several times, and then dried over anhydrous sodium sulfate, followed by filtration to form a liquid explosive mixture containing predominantly hexanitrate, and lower nitrates of the sorbitol. This liquid explosive can be used in conjunction with nitrocellulose or other similar explosives for making smokeless powders, and other propellant compositions.

Notes:

14-02. Quebrachitol nitrate. *Monomethyl cyclohexanepentanitrate*

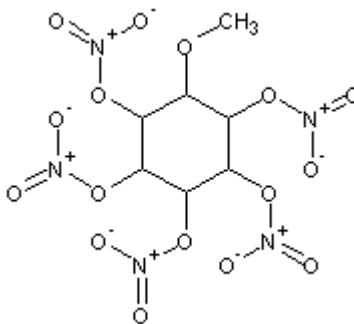

Quebrachitol nitrate

Quebrachitol nitrate is a transparent, viscous liquid, which is insoluble in water and acid. The compound is quite stable and much less sensitive than nitroglycerine. Quebrachitol nitrate shows excellent use as a high power substitute for nitroglycerine in dynamites and high performance gun propellants. It can also be used in making blasting gelatins with ammonium nitrate and fuel oil.

Molecular weight: 419.170	Flammability: Generally nonflammable but may flash on ignition
Detonating velocity: Similar to PETN	Toxicity: Low
Sensitivity: Moderate	Classification: Secondary explosive
Stability: Good	Overall value (as secondary explosive): High

Procedure 14-02A: Preparation of Quebrachitol nitrate

Materials:	1. 40 grams quebrachitol
	2. 80 grams 99% nitric acid
	3. 80 grams of 98% sulfuric acid
	4. 200 milliliters 10% baking soda solution

Summary: Quebrachitol nitrate can be prepared by reacting quebrachitol with 99% nitric acid in the presence of concentrated sulfuric acid. After the reaction, the mixture is simply stirred for a short period of time, where upon it is allowed to stand after stirring. As the mixture stands, an insoluble layer of the quebrachitol nitrate separates. This layer is then easily recovered by decantation, or by using a separatory funnel. Commercial & Industrial note: For related, or similar information, see Serial No. 479,079, June 12, 1934, by E.I. DuPont de Nemours & Company, to Charles E. Burke and Russell McGill, both of Wilmington, DEL. Part or parts of this laboratory process may be protected by international, and/or commercial/industrial processes. Before using this process to legally manufacture the mentioned explosive, with intent to sell, consult any protected commercial or industrial processes related to, similar to, or additional to, the process discussed in this procedure. This process may be used to legally prepare the mentioned explosive for laboratory, educational, or research purposes.

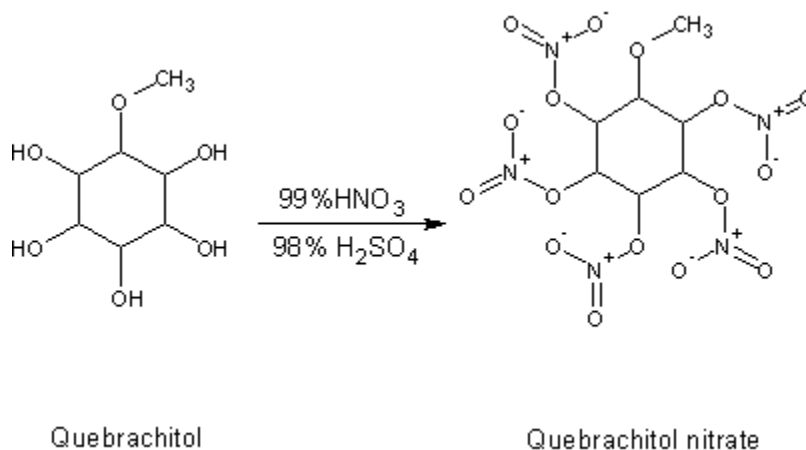

Reaction Equation

Hazards: Use extreme caution when handling 99% nitric acid. 99% Nitric acid is highly volatile, and emits highly poisonous fumes of nitrogen oxides. Wear gloves, proper lab clothing, and use maximum ventilation when handling. Wear gloves and proper clothing when handling 98% sulfuric acid.

Procedure: Place 80 grams of 99% nitric acid into a suitable flask, and then cool to 10 Celsius by means of an ice water bath. Afterwards, gradually add 40 grams of quebrachitol over a suitable period as to maintain the nitric acid temperature at about 10 Celsius. During the addition, rapidly stir the nitric acid. After the addition of the quebrachitol, moderately add 80 grams of 98% sulfuric acid at a sufficient rate as to allow the reaction mixtures temperature to rise to about 25 Celsius, but no higher. During the addition of the sulfuric acid, rapidly stir the reaction mixture. After the addition of the sulfuric acid, rapidly stir the reaction at 25 Celsius for 2 hours. After stirring for 2 hours, stop stirring, and allow the reaction mixture to settle. During this time, an insoluble layer will form. Then, decant the upper layer of quebrachitol nitrate, wash with several hundred milliliters of water, 200 milliliters of 10% baking soda solution, and finally with 500 hundred milliliters of cold water. Note: During the washings, the quebrachitol nitrate will be the bottom layer, as long as no sulfuric acid is present. After washing, the nitrate will be well suitable for use in explosives mixtures of the nitroglycerine type. Note: Quebrachitol nitrate should be stored in an amber glass bottle in a refrigerator.

Notes:

14-03. Inositol nitrate. *Inositol hexanitrate*

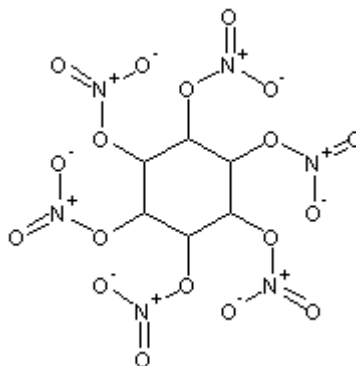

Inositol nitrate

Inositol nitrate is a colorless, syrupy, oily liquid. The compound is surprisingly stable, and is similar in stability to Quebrachitol nitrate. The liquid is very soluble in acetone, concentrated sulfuric acid, methyl alcohol, and ether. A small sample flashes when dropped onto a heated plate, but does not detonate. Inositol nitrate is capable of gelatinizing nitrocellulose, and hence, is a valuable component for nitrocellulose blasting compositions, and high performance rocket propellants. It can also be used to gelatinize nitro starch. Inositol can be used in making nitroglycerine free dynamites, gun propellants, and blasting compositions with RDX, TNT, HMX, PETN, or other secondary explosives.

Molecular weight: 450.141	Flammability: Generally nonflammable but flashes on ignition
Detonating velocity: 7800 (estimated)	Toxicity: Moderate
Sensitivity: Moderate	Classification: Secondary explosive
Stability: Good	Overall value (as secondary explosive): High

Procedure 14-03A: Preparation of Inositol nitrate

Materials:	1. 150 grams of quebrachitol
	2. 200 grams 57% hydroiodic acid
	3. 420 grams 95% ethanol
	4. 40 grams of diethyl ether

CHAPTER 14: THE PREPARATION OF POLYHYDRIC NITRATE ESTERS

	5. 84 grams 99% nitric acid
	5. 172 grams 98% sulfuric acid
	6. 200 milliliters of 10% baking soda solution
	7. 100 grams of anhydrous sodium sulfate

Summary: Inositol nitrate is prepared by first, reacting quebrachitol with hydroiodic acid. The resulting product, inositol, is then treated with a nitrating acid. The inositol nitrate is then separated by decantation, and then dried over anhydrous sodium sulfate. Commercial & Industrial note: For related, or similar information, see Serial No. 474,067, March 22nd, 1932, by Hercules Powder Company, to Willard Crater, Succasunna, NJ. Part or parts of this laboratory process may be protected by international, and/or commercial/industrial processes. Before using this process to legally manufacture the mentioned explosive, with intent to sell, consult any protected commercial or industrial processes related to, similar to, or additional to, the process discussed in this procedure. This process may be used to legally prepare the mentioned explosive for laboratory, educational, or research purposes.

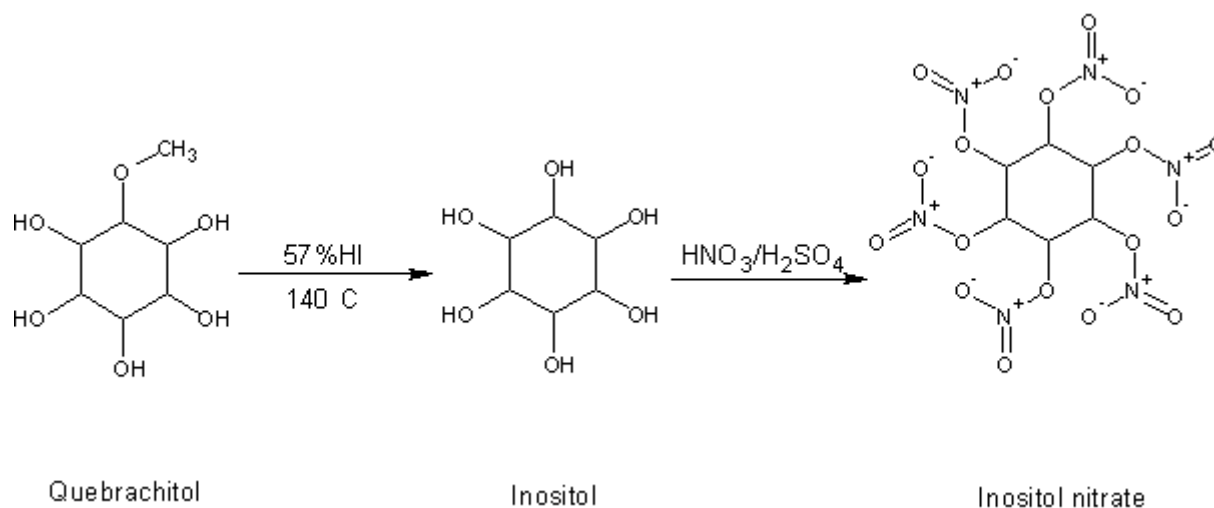

Reaction Equation

Hazards: Use extreme caution when handling 99% nitric acid. 99% Nitric acid is highly volatile, and emits highly poisonous fumes of nitrogen oxides. Wear gloves, proper lab clothing, and use maximum ventilation when handling. Wear gloves and proper clothing when handling 98% sulfuric acid.

Procedure:

Step 1: Preparation of Inositol

Into a suitable flask, add 150 grams of quebrachitol, and then 200 grams of 57% hydroiodic acid. Then place the mixture into a reflux apparatus and reflux at 140 Celsius for 1 hour. After 1 hour, raise the temperature to about 145 Celsius, and continue to heat for 3 hours. Note: Use proper ventilation, as a steady stream of gas is evolved. After heating for 3 hours, remove the heat source and allow the reaction mixture to cool to room temperature. Then place the reaction mixture into a wide mouth beaker, and allow the product to crystallize. After the product crystallizes from the reaction mixture, filter-off the crystals, wash with 100 grams of cold 95% ethanol (several times using the same washing portion), and then vacuum dry or air-dry the product. After which, dissolve this dry product into 1000 milliliters of warm water, and then pass this solution through a glass column filled with activated carbon. After passing the solution through the activated carbon, place it into a rotary evaporator and remove the water under vacuum until a syrupy consistency remains. Note: if a rotary evaporator is not available, place the solution into a shallow pan, and blow air over it until a syrupy consistency remains; this process could take days. When a syrupy consistency remains, remove the product from the evaporator or shallow pan, and then add to a solvent mixture prepared by dissolving 40 grams of diethyl ether into 320 grams of 95% ethanol with rapid stirring. After which, collect the precipitated crystals by filtration, and then vacuum dry.

Step 2: Preparation of Inositol nitrate

Prepare a nitrating acid solution by adding 84 grams of 99% nitric acid into suitable flask, and then add 116 grams of 98% sulfuric acid. Then cool this nitrating acid mixture to 5 Celsius by means of an ice bath. After which, gradually add 40 grams of

CHAPTER 14: THE PREPARATION OF POLYHYDRIC NITRATE ESTERS

inositol (prepared in step 1) over a period sufficient enough to keep the nitrating acid around 5 Celsius. During the addition, rapidly stir the nitrating acid. After the addition, remove the ice bath, and allow the mixture to warm to about 20 Celsius. Then continue stirring rapidly for 1 hour at 20 Celsius. After which, stop stirring, and allow the reaction mixture to settle for 30 minutes. Then decant the upper inositol nitrate layer, and place this layer into cold water. Then mix the bottom acid layer with 500 milliliters of cold water, and then allow this mixture to settle for ten minutes. After which, decant the upper inositol nitrate layer, and add it to the first decanted inositol nitrate layer in the cold water. Afterwards, add 200 milliliters of 10% baking soda solution to the inositol nitrate/water mixture, and stir for ten minutes. Then decant the bottom inositol nitrate layer (note: the inositol nitrate layer maybe the top layer, depending if sulfuric acid is present). Thereafter, add 100 grams of anhydrous sodium sulfate, and then stir for ten minutes. Finally, filter-off the sodium sulfate, and then place the inositol nitrate into an amber glass bottle, and store in a refrigerator until use.

Notes:

14-04. MGP. *N*-Methyl gluconamide pentanitrate

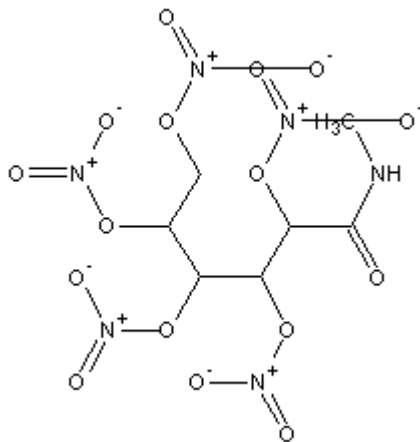

MGP

Uses: See Inositol nitrate

Molecular weight: 422.172	Flammability: Generally nonflammable but may flash on ignition
Detonating velocity: Uncalculated	Toxicity: Moderate
Sensitivity: Moderate	Classification: Secondary explosive
Stability: Good	Overall value (as secondary explosive): Moderate

Procedure 14-04A: Preparation of MGP

Materials:	1. 400 milliliters 99% nitric acid
	2. 100 grams of N-methyl gluconamide
	3. 400 milliliters of acetic anhydride
	4. 200 milliliters of 10% baking soda solution
	5. 1000 milliliters methanol

Summary: MGP can be prepared by treating N-methyl gluconamide with 99% nitric acid in the presence of acetic anhydride. After the reaction, the reaction mixture is treated with ice, where upon the product precipitates. It is then collected by filtration, washed and then dried. Purification is accomplished by recrystallization from methanol. Commercial & Industrial note: For related, or similar information, see Serial No. 424,903, June 22nd, 1948, by E.I. Dupont de Nemours & Company, to William Federick Filbert, Woodbury, NJ. Part or parts of this laboratory process may be protected by international, and/or commercial/industrial processes. Before using this process to legally manufacture the mentioned explosive, with intent to sell, consult any protected commercial or industrial processes related to, similar to, or additional to, the process discussed in this

procedure. This process may be used to legally prepare the mentioned explosive for laboratory, educational, or research purposes.

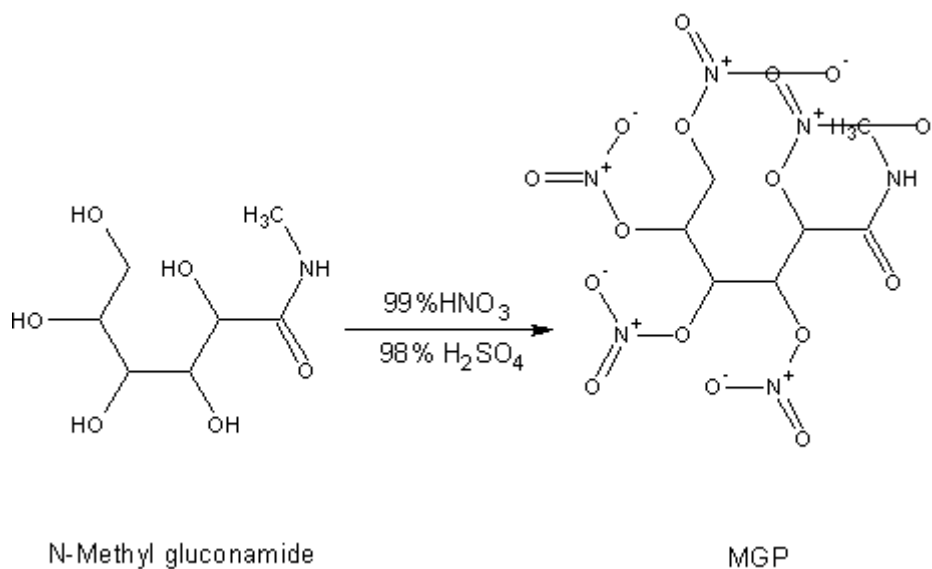

Reaction Equation

Hazards: 99% Nitric acid is a very dangerous substance. Wear gloves, proper lab clothing, and use maximum ventilation when handling. Fumes from 99% nitric acid are highly poisonous, and corrosive; use care. Wear gloves when handling acetic anhydride.

Procedure: Into a suitable flask, add 400 milliliters of 99% nitric acid, and then cool this acid to -5 Celsius by means of an ice bath. When the acid reaches -5 Celsius, gradually add 100 grams of N-methyl gluconamide at a sufficient rate as to keep the nitric acid at -5 Celsius. During the addition, rapidly stir the nitric acid. After the addition of the N-methyl gluconamide, gradually add 400 milliliters of acetic anhydride at a sufficient rate as to keep the reaction mixture temperature below 5 Celsius with constant stirring. After the addition of the acetic anhydride, add 700 grams of crushed ice into the reaction mixture, and continue stirring rapidly. Then, filter-off the precipitated product, wash with 200 milliliters of ice cold water, then with 200 milliliters of 10% cold baking soda solution, and then with plenty of ice cold water. Afterwards, vacuum dry or air-dry the product. The product can be recrystallized from 1000 milliliters of methanol, washed with cold water, and dried to yield high purity MGP.

Notes:

14-05. MON. *Maltose octanitrate*

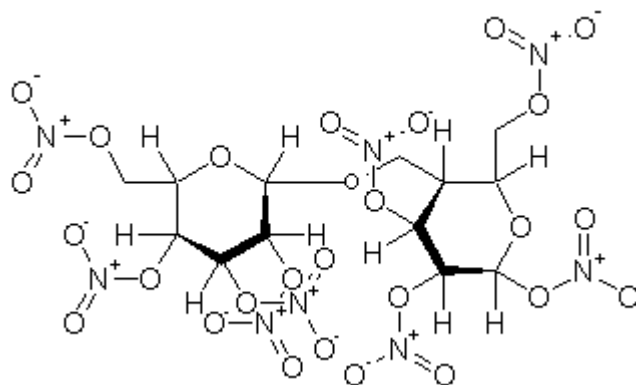

MON

MON forms yellowish white to off-white to yellowish transparent to yellowish crystals with a melting point of 134 Celsius. The crystals begin to decompose which headed to 170 Celsius. MON is readily soluble in 95% ethyl alcohol, but insoluble in water. The crystals are very stable, and can be used in melt cast explosives with TNT, or other low melting secondary explosives. MON is also used in the preparation of high performance rocket propellants when mixed with flash reducing agents and smoke reducing agents. MON can form a binary plastic explosive when slurried with a high-energy plasticizers, and RDX. MON should be stored in amber glass bottles and in a refrigerator for no more then 30 days—as it may decompose slowly. Explosive slurries, or compositions of MON with other explosives or agents are stable for up to 2 years.

Molecular weight: 730.330	Flammability: Flammable—may flash on ignition
Detonating velocity: Uncalculated	Toxicity: Moderate
Sensitivity: Low	Classification: Secondary explosive
Stability: Good	Overall value (as secondary explosive): Above Moderate

Procedure 14-05A: Preparation of MON

Materials:	1. 64 grams of anhydrous maltose
	2. 2 grams of urea
	3. 135 milliliters of 99% nitric acid
	4. 100 milliliters of 30% fuming sulfuric acid or 150 milliliters of 98% sulfuric acid
	5. 500 milliliters of a 5% sodium bicarbonate solution
	6. 200 milliliters of diethyl ether
	7. 90 milliliters of 95% ethyl alcohol

Summary: MON is prepared by nitrating maltose with 99% nitric acid in the presence of urea, followed by the presence of fuming sulfuric acid. The urea is added to form a urea nitroso intermediate, which aids in the nitration of the maltose. After the reaction, the mixture is refluxed for a short period, and then drowned into ice water to precipitate the product. Recrystallization yields a purity of 99%.

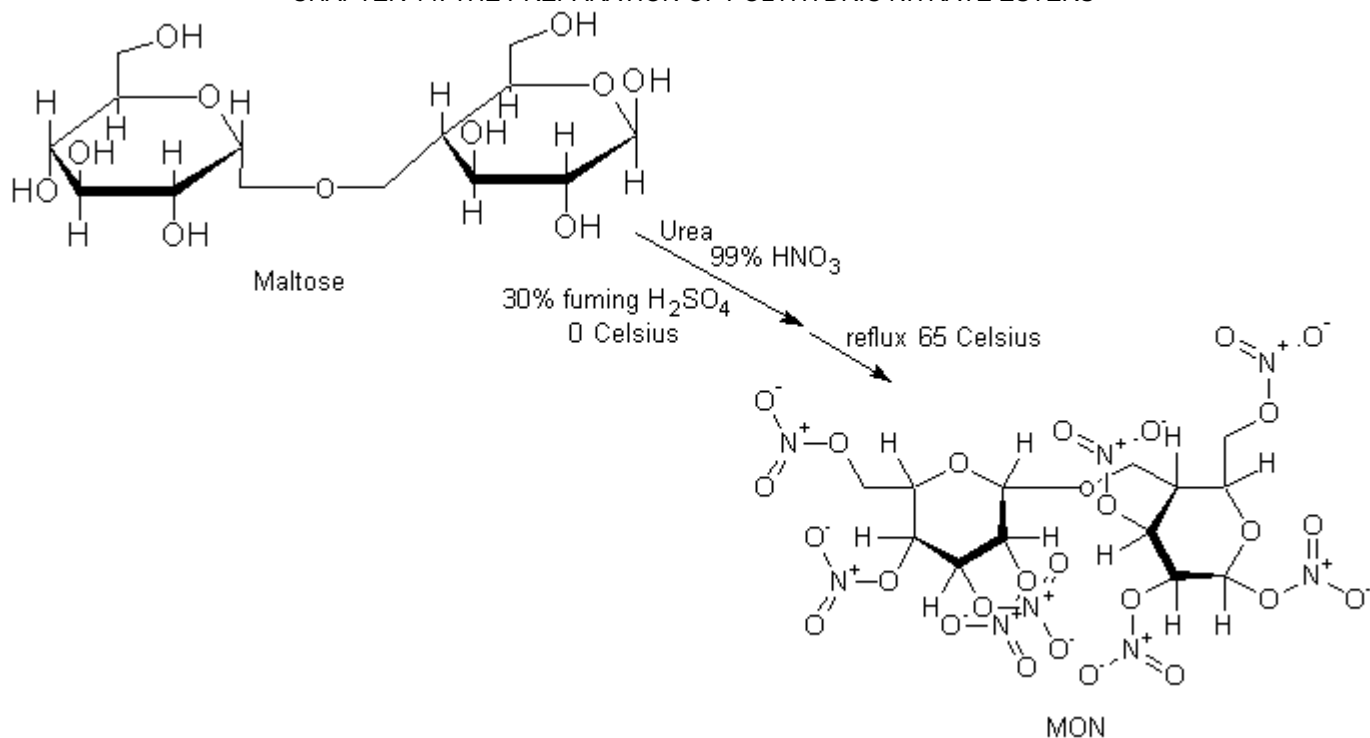
*Reaction Equation*

Hazards: Use great care when handling 99% nitric acid, which is highly toxic and evolves highly toxic and corrosive fumes—use maximum ventilation. Use great care when handling fuming sulfuric acid, which evolves highly toxic and extremely corrosive vapors of sulfur trioxide—use with maximum care and ventilation. Extinguish all flames before using diethyl ether and 95% ethyl alcohol, both of which are highly flammable.

Procedure: Into suitable beaker of pestle, add 64 grams of anhydrous maltose, and then thoroughly blend this with 2 grams of urea. Thereafter, place 135 milliliters of 99% nitric acid into a flask equipped with motorized stirrer, thermometer, and powder funnel, and then place this flask into an ice bath and chill to 0 Celsius. When the nitric acid reaches a temperature of 0 Celsius, slowly add the maltose/urea blended mixture over a period of 90 minutes (in small pieces at a time), while rapidly stirring the nitric acid, and keeping its temperature below 5 Celsius. After the addition of the maltose/urea dry mixture, replace the powder funnel with an addition funnel, and then fill this addition funnel with 100 milliliters of 30% fuming sulfuric acid (note: this fuming acid can be replaced by using 150 milliliters of 98% sulfuric acid). Then slowly add the sulfuric acid, drop by drop, over a period of 2 hours while rapidly stirring the reaction mixture and maintaining its temperature below 5 Celsius. Once all the sulfuric acid has been added, remove the ice bath, and allow the reaction mixture to warm to room temperature. Thereafter, reflux the reaction mixture at 65 Celsius for 1 hour with constant stirring. After refluxing for 1 hour, remove the heat source and allow the reaction mixture to cool to room temperature (maintain constant stirring during the cool down period). Once the reaction mixture has cooled to room temperature, drown the entire reaction mixture into 500 milliliters of ice water. Then filter-off the precipitated product, wash with 500 milliliters of a 5% sodium bicarbonate solution, followed by washing with three 200 milliliter portions of cold water. Thereafter, vacuum dry or air dry the solid product. These dry crystals will be of 97 to 98% purity, and can be purified to 99% by recrystallizing them from a solvent mixture prepared by mixing 200 milliliters of diethyl ether with 90 milliliters of 95% ethyl alcohol. After recrystallizing the product, vacuum dry or air dry the crystals. Note: For long-term storage of MON, you should carryout the recrystallization process.

Notes:

14-06. MX. Nitromannite; Dilangil; Nitranitol; Mannitol hexanitrate

CHAPTER 14: THE PREPARATION OF POLYHYDRIC NITRATE ESTERS

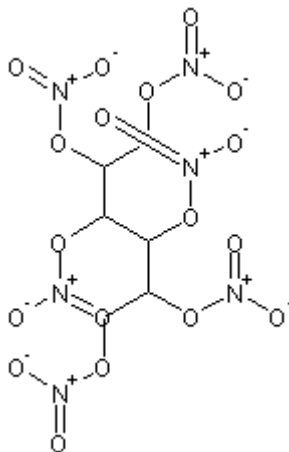

MX

MX forms a white powder to colorless crystals, which may have a light yellowish to grayish tint. MX forms long needles in large clusters when recrystallized from alcohol. The crystals have a melting point of 108 Celsius. The crystals are soluble in alcohol, and ether, but insoluble in water. MX is relatively stable but begins to decompose regularly when heated to 75 Celsius. However, MX can be used in making initiating compositions when admixed with small amounts of sodium carbonate, tri sodium phosphate, or chalk.—MX detonates upon strong percussion. The stability of MX is great enough to allow it to be employed in explosives compositions, which it quite often is. It can be slurried with nitroglycerine or other liquid nitrate esters and mixed with a inert filler such as diatomaceous earth for use in blasting dynamites. MX is also widely used in high performance gun propellants with nitroglycerine, nitrocellulose, or nitro starch, and when desensitized with sodium nitrate, or potassium nitrate and inert filler. MX is capable of forming high-energy rocket propellants when admixed with ammonium perchlorate, aluminum, and a glue binder.

Molecular weight: 452.157	Flammability: Flammable—may flash on ignition
Detonating velocity: 7065 (calculated)	Toxicity: Moderate
Sensitivity: Moderate	Classification: Secondary explosive
Stability: Moderate	Overall value (as secondary explosive): High

Procedure 14-06A: Preparation of MX

Materials:	1. 110 milliliters of 99% nitric acid
	2. 100 milliliters of 98% sulfuric acid
	3. 22 grams of anhydrous D-mannitol
	4. 500 milliliters of a 5% sodium bicarbonate solution

Summary: MX is easily prepared by nitrating D-mannitol with 99% nitric acid in the presence of 98% sulfuric acid. The reaction is swift, and the resulting mixture is then gently heated to provoke crystallization of the product. After the heating process, the reaction mixture is cooled, drown into cold water, filtered, and the product washed and then dried.

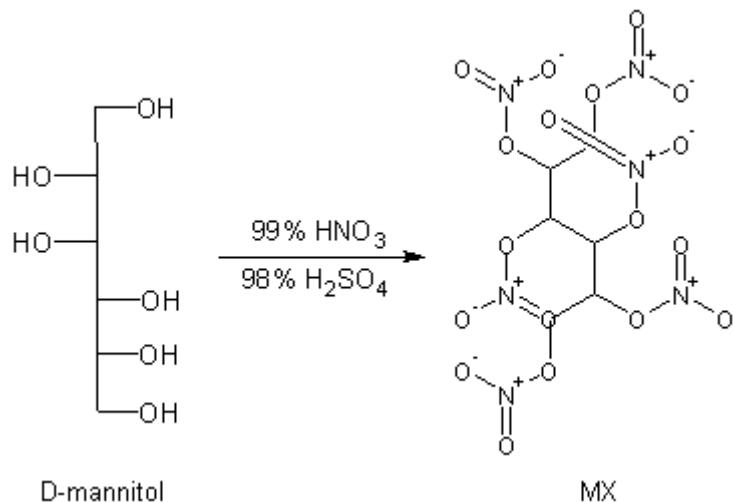
*Reaction Equation*

Hazards: Use great care when handling 99% nitric acid, which is highly toxic and evolves highly toxic and corrosive fumes—use maximum ventilation. Use great care when handling concentrated sulfuric acid, which is extremely corrosive.

Procedure: Into a suitable flask equipped with a motorized stirrer, thermometer, and powder funnel, place 110 milliliters of 99% nitric acid, followed by 100 milliliters of 98% sulfuric acid, and then place this flask into an ice bath and chill to 0 Celsius. Thereafter, slowly add in small portions, 22 grams of anhydrous D-mannitol while rapidly stirring the nitric acid, and maintaining its temperature below 5 Celsius. After the addition of the D-mannitol, continue to stir the reaction mixture for 1 hour at 0 Celsius. After stirring for 1 hour, remove the ice bath, and allow the reaction mixture to warm to room temperature. Then gently heat the reaction mixture to 50 Celsius for 1 hour while constantly stirring. After heating for 1 hour, remove the heat source, and allow the reaction mixture to cool to room temperature. Thereafter, drown the entire reaction mixture into 500 milliliters of ice water, and then allow this whole mixture to stand for 12 hours. Then filter-off the insoluble product, wash with 500 milliliters of a 5% sodium bicarbonate solution, followed by three 250 milliliters portions of cold water. Afterwards, vacuum dry or air-dry the solid product.

Notes:

14-07. PVN. *Polyvinylnitrate*

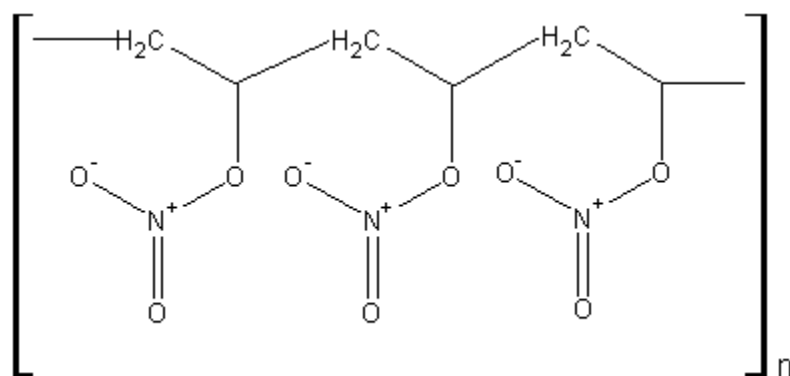

PVN

PVN forms a white to off-white tan powder, with a melting point of 170 Celsius. The powder begins to decompose when heated to 175 Celsius, and may ignite at 180 Celsius. PVN is an interesting explosive as it is a polymer with a massive molecular weight. Unlike explosives such as RDX, and HMX, PVN is capable of forming true life plastic “plastic” explosives

CHAPTER 14: THE PREPARATION OF POLYHYDRIC NITRATE ESTERS

when dissolved into low melting plastics to form solid true based plastic compositions that can be used in making a variety of plastic objects for use in everyday items such as pens, CD-covers, foam insulation, plastic tubes, covers, bowls, ect., ect., These plastic items are very stable and resistant to heat, shock, friction, and percussion and can last for many decades. These plastic items can only be detonated with a significant booster of RDX or tetryl at a ratio of 1 part booster to 10 parts PVN/plastic polymer explosive. However, many of these plastic compositions are still new and being developed. Under most conditions, PVN is used primarily as a high energy bases material for solid rocket propellants when mixed with perchlorates, nitroglycerine, EGDN, or nitrocellulose, and inert solvent binders such as poly propylene glycol, or others.

Molecular weight: 100,000+	Flammability: Flammable—burns with smoky flame
Detonating velocity: 5090 (estimated)	Toxicity: Low
Sensitivity: Very low	Classification: Secondary explosive
Stability: Very good	Overall value (as secondary explosive): Moderate

Procedure 14-07A: Preparation of PVN

Materials:	1. 600 milliliters of 99% nitric acid
	2. 500 milliliters of methylene chloride
	3. 250 milliliters of acetic anhydride
	4. 32 grams of dry powdered polyvinyl alcohol
	5. 250 milliliters of a 5% sodium bicarbonate solution
	6. 250 milliliters of 95% ethyl alcohol

Summary: PVN is conveniently prepared by reacting polyvinyl alcohol (PVA) with 99% nitric acid in the presence of acetic anhydride in methylene chloride. The reaction is mild, and is kept at a temperature below 0 Celsius at all times to avoid decomposition of the polyvinyl alcohol. After the initial reaction, the reaction mixture is refluxed for a short period of time, and then evaporated to remove the solvent. Thereafter, the PVN product is collected by drowning the reaming reaction mixture into ice-cold water, followed by filtration, washing, and then drying.

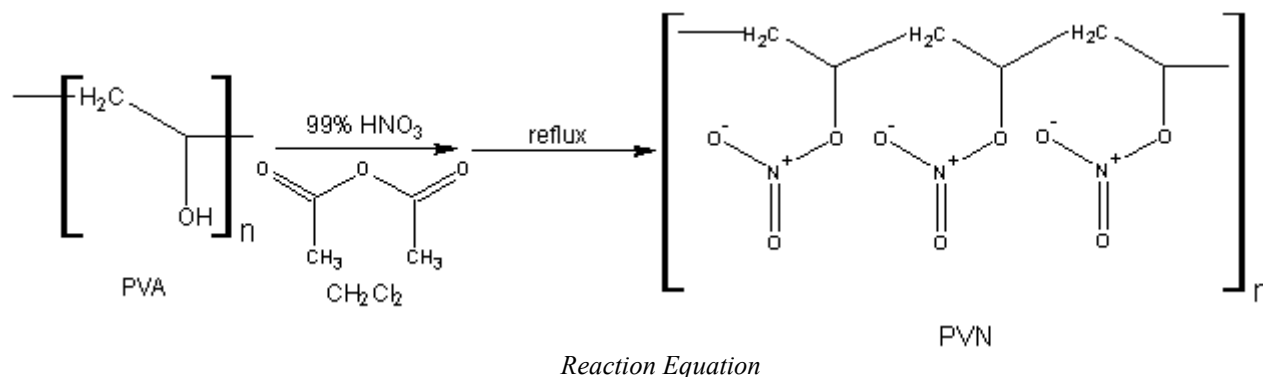

Hazards: Use great care when handling 99% nitric acid, which is highly corrosive and evolves highly toxic fumes of nitrogen oxides—use maximum ventilation. Acetic anhydride is corrosive and can cause mild skin irritation. Extinguish al flames before using 95% ethyl alcohol, which is flammable.

Procedure: Note: This procedure uses an excessive amount of 99% nitric acid to properly carryout the reaction. This excessive amount of acid can be recovered by treating the reaction mixture (after complete removal of the product) with methylene chloride to recover the nitric acid. Prior to this action, a small amount of sulfuric acid should be added to the reaction mixture. Afterwards, the reaction mixture should be extracted with several volumes of methylene chloride. These combined volumes can then be carefully distilled to recover the nitric acid of 99% purity (see nitric acid, 90% and 99% respectively).

Into a suitable flask equipped with a motorized stirrer, thermometer, and powder funnel, add 600 milliliters of 99% nitric acid, followed by 500 milliliters of methylene chloride, followed by 250 milliliters of acetic anhydride. Then place this flask into a salt/ice bath, and chill to -10 Celsius. When this mixtures temperature reaches -10 Celsius, slowly add, in small portions, 32 grams of dry powdered polyvinyl alcohol polymer, over a period of about 3 hours while rapidly stirring the nitric acid and maintaining its temperature at -10 Celsius. After the addition of the polyvinyl alcohol, continue to stir the reaction mixture for 2 additional hours at -10 Celsius. Thereafter, remove the salt/ice bath, and allow the reaction mixture to warm to room temperature. Afterwards, remove the powder funnel, and replace it with a condenser, and then gently reflux the reaction mixture at 40 Celsius for 1 hour. Then remove the heat source, and allow the reaction mixture to cool to room temperature. Thereafter, Place the entire reaction mixture into a distillation apparatus or rotary evaporator, and remove the methylene

CHAPTER 14: THE PREPARATION OF POLYHYDRIC NITRATE ESTERS

chloride solvent under mild heat and/or vacuum. Once all the methylene chloride has been removed, drown the remaining reaction mixture into 1500 milliliters of ice-cold water. Thereafter, filter-off the precipitated product, wash with 250 milliliters of a 5% sodium bicarbonate solution, followed by 250 milliliters of 95% ethyl alcohol, followed by 250 milliliters of ice cold water. Thereafter, vacuum dry or air-dry the product. Before using, this dry product should be stored in a desiccator for 48 hours prior to use.

Notes:

CHAPTER 15: THE PREPARATION OF NITRATE ESTER NITRAMINES

NMHAN, DINA, DNAN, NENA, SILVER NENA

15-01. NMHAN. *N-Nitro-N-methylhydroxy acetamidenitrate*

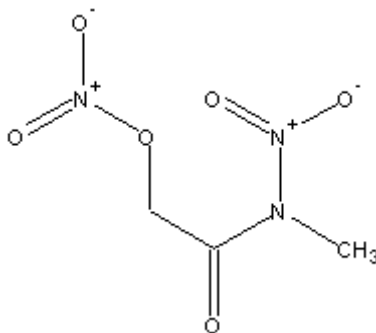

NMHAN

NMHAN forms creamy-white flat crystals, or rectangular prisms with a melting point of 81 Celsius. It has limited use in explosives, but can be used as a satisfactory substitute for RDX in blasting caps and detonators. NMHAN may demonstrate a usefulness in priming compositions when mixed with lead styphnate or lead azide. It can form stable shock resistant explosives when alloyed with TNT, or other low melting secondary explosives.

Molecular weight: 179.088	Flammability: Burns with smoky flame but may flash on strong ignition
Detonating velocity: Uncalculated	Toxicity: Low
Sensitivity: Low	Classification: Secondary explosive
Stability: Good	Overall value (as secondary explosive): Moderate

Procedure 15-01A: Preparation of NMHAN

Materials:	1. 100 grams N-methylhydroxy acetamide
	2. 20 milliliters 99% nitric acid
	3. 300 grams 98% sulfuric acid

Summary: NMHAN is conveniently prepared by nitrating N-methylhydroxy acetamide with 99% nitric acid in the presence of concentrated sulfuric acid. The resulting reaction mixture is then heated, cooled, and then drowned into ice water to precipitate the product. The product is then washed with plenty of cold water, and then vacuum dried. Commercial & Industrial note: Part or parts of this laboratory process may be protected by international, and/or commercial/industrial processes. Before using this process to legally manufacture the mentioned explosive, with intent to sell, consult any protected commercial or industrial processes related to, similar to, or additional to, the process discussed in this procedure. This process may be used to legally prepare the mentioned explosive for laboratory, educational, or research purposes.

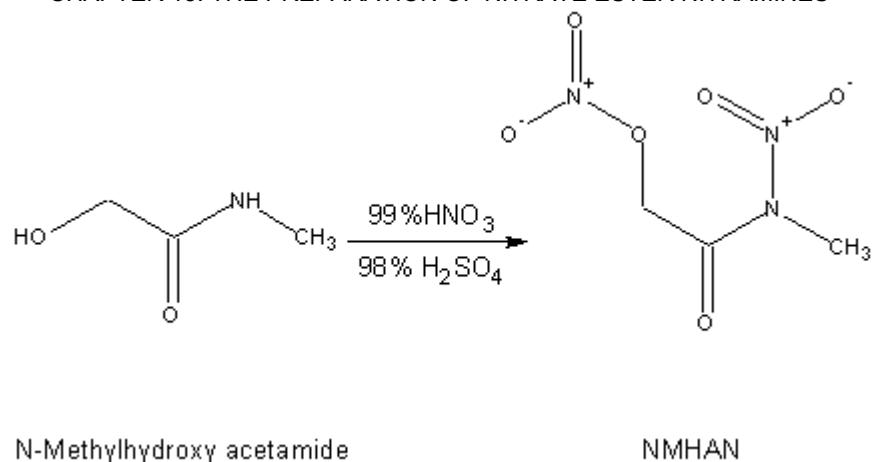
*Reaction Equation*

Hazards: 99% Nitric acid is a very dangerous substance. Wear gloves, proper lab clothing, and use maximum ventilation when handling. Fumes from 99% nitric acid are highly poisonous, and corrosive; use care. Wear gloves and proper lab clothing when handling 98% sulfuric acid.

Procedure: Place 300 milliliters of 99% nitric acid into a suitable flask, and then place this acid into an ice bath and chill to 0 Celsius. When the temperature reaches 0 Celsius, gradually add 100 grams of N-methylhydroxy acetamide while rapidly stirring the nitric acid and maintain its temperature at 0 Celsius during the addition. After the addition, gradually add 300 grams of 98% sulfuric acid at a rate sufficient to keep the reaction temperature below 5 Celsius. After the addition of the sulfuric acid, remove the ice bath and allow the reaction mixture to warm to room temperature. After which, heat the reaction mixture to 50 Celsius with stirring. Note: at 50 Celsius, an active evolution of gas will result. When the temperature reaches 50 Celsius, remove the heat source, and allow the reaction mixture to cool to room temperature. After which, add the entire reaction mixture into 1000 milliliters of ice water. Then, filter-off the precipitated solid, wash with plenty of warm water, and then vacuum dry or air-dry the product.

Notes:

15-02. DINA. *Dinitroxydiethylnitramine*

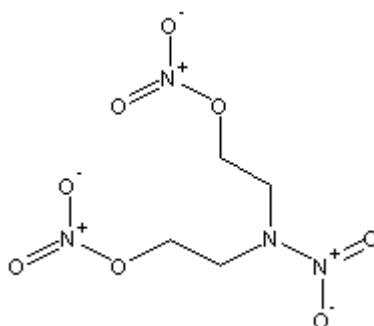

DINA

DINA forms white flocculent crystals with a melting point of 51 Celsius. It forms flattened prisms when recrystallized from acetone. The crystals are very soluble in acetone, methanol, ethanol, ether, benzene, and glacial acetic acid. The crystals however, are insoluble in water, carbon tetrachloride, and petroleum ether. DINA begins to decompose with the evolution of gas when heated to 165 Celsius. It can be decomposed rapidly with sulfuric acid, even at temperatures ranging from 5 to 0

CHAPTER 15: THE PREPARATION OF NITRATE ESTER NITRAMINES

Celsius—boiling DINA in alkali solutions also causes decomposition. DINA is relatively stable, but may be detonate by significant shock, or percussion—it is easily detonated by primary explosives. DINA is relatively easy to work with and is non-toxic. The potential uses for DINA are increasing steadily, and it has found numerous benefits in hollow charges when alloyed with TNT, or other low melting secondary explosives—penetration is increased by DINA. It is widely used in explosives either by itself or mixed with other compounds such as RDX, HMX, ect. For use in shells and bombs, DINA should be desensitized with TNT, RDX, or other melt castable explosives. New plastic explosives composed of DINA and a inert plasticizer are finding new uses in demolitions, as are new high energy rocket propellants composed of DINA, RDX, and a high energy plasticizer.

Molecular weight: 240.128	Flammability: Burns with little violence, but may detonate shortly after ignition
Detonating velocity: 7800 (estimated)	Toxicity: Low
Sensitivity: Moderate	Classification: Secondary explosive
Stability: Good	Overall value (as secondary explosive): Very High

Procedure 15-02A: Preparation of DINA

Materials:	1. 1700 grams acetic anhydride
	2. 20 grams 35 - 38% hydrochloric acid
	3. 420 grams diethanolamine
	4. 3200 milliliters methylene chloride
	5. 849 grams 70% nitric acid
	6. 400 milliliters of 5% sodium bicarbonate solution (<i>prepare by dissolving 20 grams of sodium bicarbonate into about 380 milliliters of water</i>)

Summary: DINA is prepared by reacting diethanolamine with hydrochloric acid, and nitric acid in methylene chloride. After the reaction, the mixture is washed with water, sodium bicarbonate solution, and then evaporated to dry residue. The dry residue is then dissolved in methylene chloride, and then passed through a column filled with silicon dioxide, which absorbs impurities. Afterwards, the filtered mixture is evaporated by distillation to yield dry product. Commercial & Industrial note: For related, or similar information, see Application No. 764,048, by Rockwell International Corporation, to Milton B. Frankel, Tarzana, CA, and Edward F. Witucki, Van Nuys, CA. Part or parts of this laboratory process may be protected by international, and/or commercial/industrial processes. Before using this process to legally manufacture the mentioned explosive, with intent to sell, consult any protected commercial or industrial processes related to, similar to, or additional to, the process discussed in this procedure. This process may be used to legally prepare the mentioned explosive for laboratory, educational, or research purposes.

Hazards: Wear gloves and use proper ventilation when handling 35 – 38% hydrochloric acid, which is a highly toxic and corrosive liquid evolving choking and corrosive fumes. Wear gloves when handling 70% nitric acid. 70% nitric acid can cause skin burns. Wear gloves when handling glacial acetic acid, which can cause skin burns.

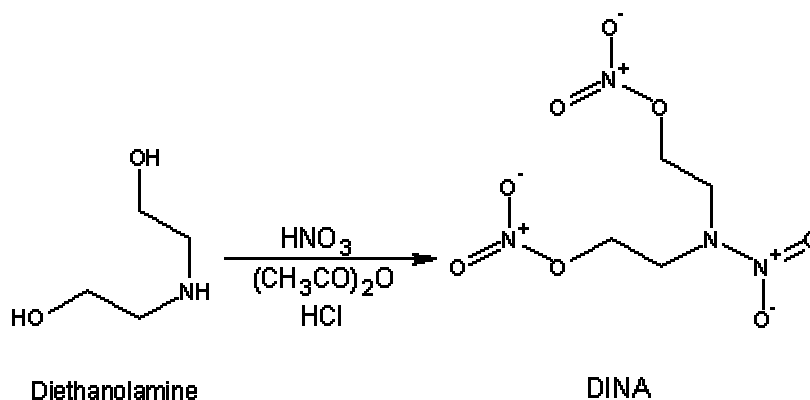

Reaction Equation

Procedure: To a 3-neck flask equipped with two addition funnels, place 1700 grams of acetic anhydride, and 20 grams of 35 – 38% hydrochloric acid. Then cool this mixture to 5 Celsius by means of an ice bath. When the temperature reaches 5 Celsius, place 849 grams of 70% nitric into the first addition funnel, and then add only 10% of it by volume, to the acetic anhydride

CHAPTER 15: THE PREPARATION OF NITRATE ESTER NITRAMINES

mixture. Then add 800 milliliters of methylene chloride to the reaction mixture, and then place 420 grams of diethanolamine into the second addition funnel. Now, remove the ice bath, and replace it with a cold-water bath. Then slowly add both the 70% nitric acid, and the diethanolamine to the reaction mixture, drop wise, and simultaneously while stirring the reaction mixture (drip the 70% nitric acid into the reaction mixture at a rate slightly faster than the diethanolamine. It should take 90 minutes for the drop wise addition of the diethanolamine, and about 70 minutes for the drop wise addition of the 70% nitric acid). Maintain the reaction mixture below 25 Celsius during the additions. After both additions are complete, gently heat the reaction mixture to 40 Celsius, and hold this temperature for ten minutes while stirring the reaction mixture.

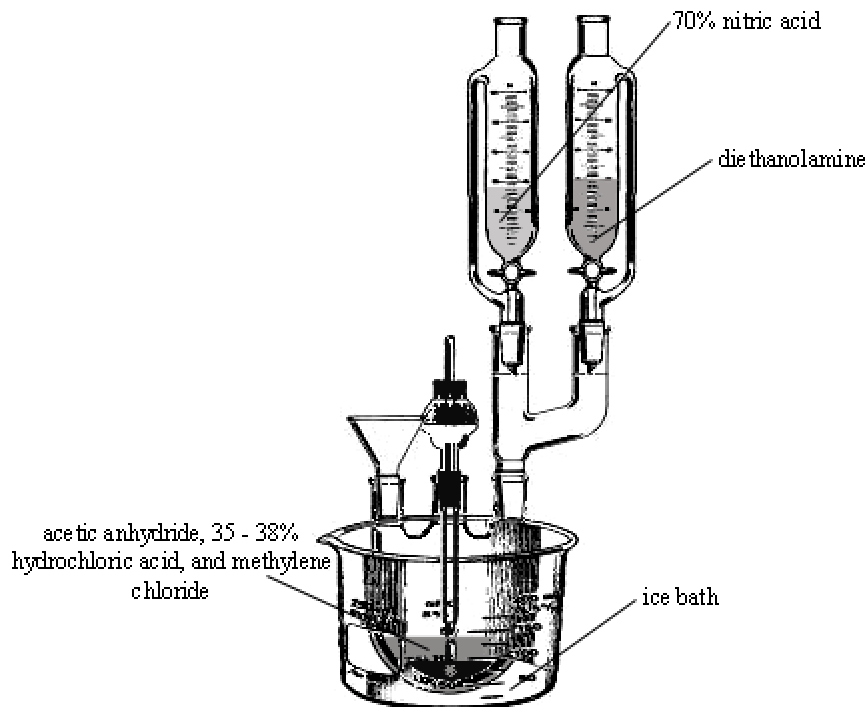

Figure 062. Apparatus for the nitration of diethanolamine

After 20 minutes, remove the heat source, and allow the reaction mixture to cool to room temperature. Afterwards, gradually add 1300 milliliters of cold water (at which time two layers will appear). Then place the reaction mixture into a separatory funnel, and drain off the bottom methylene chloride layer, which contains the product. Afterwards, extract the upper water layer with four 100-milliliter portions of methylene chloride, and after the extraction (the methylene chloride will be the bottom layer each time) combine both layers with the previously removed bottom methylene chloride layer. Then add 1200 milliliters of cold water to the combined methylene chloride portions, and stir the two-layer mixture for 10 minutes. Shortly after adding the water, add 400 milliliters of a 5% sodium bicarbonate solution while stirring the two-layer mixture, and then stir for 20 minutes. After 20 minutes, stop stirring, and then place the two-layer mixture into a separatory funnel. Then drain off the bottom methylene chloride layer. After which, stir the drained-off methylene chloride layer once more with 500 milliliters of cold water. Then place the two-layer mixture into a separatory funnel, and drain off the bottom methylene chloride layer. Now, place the drained off methylene chloride layer into a distillation apparatus, and distill the mixture at 40 Celsius until dry solid remains. When dry solid remains, stop heating, and allow the dry solid to cool to room temperature. After which, remove the dry solid from the distillation flask, and then dissolve in 2000 milliliters of methylene chloride. Afterwards, pass this methylene chloride mixture through a column of silicon dioxide 4 times. Much of the color will be removed during this process. After passing the methylene chloride through the column 4 times, place the methylene chloride mixture into a distillation apparatus, and distil at 40 Celsius until dry solid remains. Then collect the dry product, wash with 400 milliliters of water, and then vacuum dry or air-dry.

Notes:

Procedure 15-02B: Preparation of DINA

Materials:	1. 630 grams 99% nitric acid
	2. 318 grams diethanolamine
	3. 1072 grams acetic anhydride
	4. 7 grams acetyl chloride
	5. 2400 milliliters of acetone
	6. 7 grams potassium carbonate

Summary: DINA is prepared by reacting diethanolamine with 99% nitric acid in the presence of acetyl chloride and acetic anhydride. In the first phase of the preparation, the nitric acid is mixed with diethanolamine, and allowed to stand overnight. Thereafter, the acid mixture is treated with acetyl chloride and acetic anhydride. The reaction mixture is then drowned into water; the product is then filtered, dissolved in acetone, and then precipitated again by the addition of water. The pure DINA is then filtered-off, washed, and dried. Commercial & Industrial note: For related, or similar information, see Application No. 478,437, March 24, 1983, by Hercules Incorporated, to Ronald L. Simmons, Destin, FL, and Herbert L. Young, Shalimar, FL. Part or parts of this laboratory process may be protected by international, and/or commercial/industrial processes. Before using this process to legally manufacture the mentioned explosive, with intent to sell, consult any protected commercial or industrial processes related to, similar to, or additional to, the process discussed in this procedure. This process may be used to legally prepare the mentioned explosive for laboratory, educational, or research purposes.

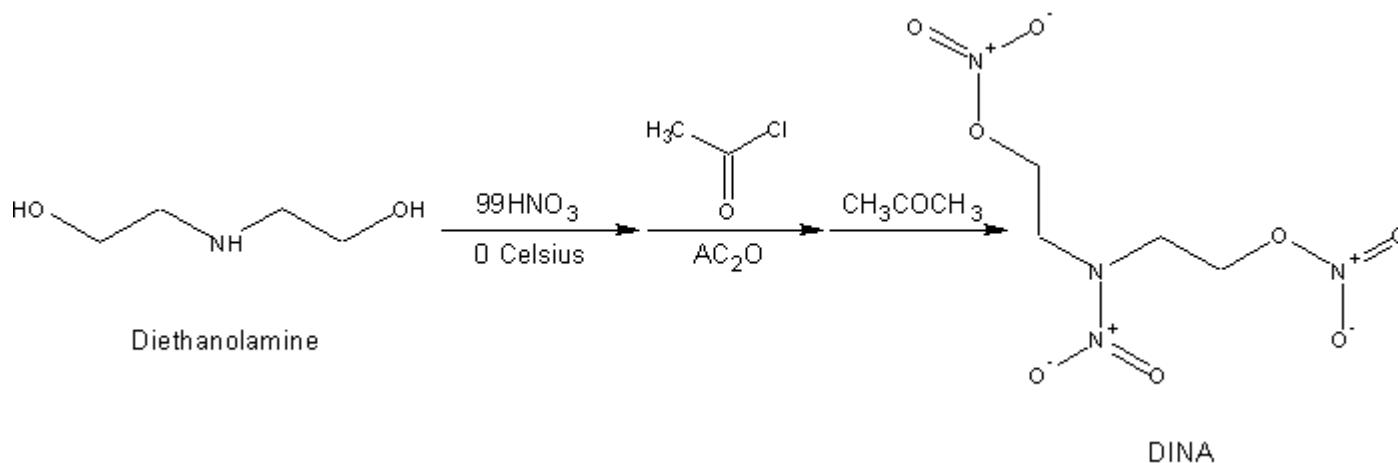

Reaction Equation

Hazards: Use maximum ventilation when handling 99% nitric acid. This acid is highly toxic and corrosive, and yields poisonous fumes of nitrogen oxides, use great care. Use ventilation, and extinguish all flames before using acetic anhydride and diethanolamine. Avoid inhalation of vapors as well.

Procedure: Note: This procedure uses an excessive amount of 99% nitric acid to properly carryout the reaction. This excessive amount of acid can be recovered by treating the reaction mixture (after complete removal of the product) with methylene chloride to recover the nitric acid. Prior to this action, a small amount of sulfuric acid should be added to the reaction mixture. Afterwards, the reaction mixture should be extracted with several volumes of methylene chloride. These combined volumes can then be carefully distilled to recover the nitric acid of 99% purity (see nitric acid, 90% and 99% respectively).

Place 630 grams of 99% nitric acid into a 3-neck flask fitted with a thermometer, and motorized stirrer. Then cool this acid to 0 Celsius by means of an ice bath. Thereafter, slowly add 318 grams of diethanolamine over a period of 8 hours while rapidly stirring the acid, and maintaining its temperature below 10 Celsius. During the addition, the diethanolamine should be added in such a way that it's added below the surface of the acid. After the addition, continue to stir the reaction mixture at about 10 Celsius for 2 hours. After which, remove the ice bath, and allow the reaction mixture to warm to 25 Celsius while stirring for 1 hour. Note: A white precipitate will form, which will then re-dissolve at 25 Celsius. After stirring for 1 hour, stop stirring and allow the reaction mixture to stand overnight at room temperature. After standing overnight, the reaction mixture will be a clear pale yellow liquid. Then, pour this reaction mixture into a dropping funnel, and then fit it to a clean 3-neck flask fitted with a motorized stirrer. Thereafter, into this 3-neck flask, add 1072 grams of acetic anhydride, and then add 7 grams of acetyl chloride. Afterwards, gently heat this acetic anhydride mixture to 30 Celsius. When the temperature reaches 30 Celsius, add the contents of the dropping funnel, drop wise, over a period of 5 hours while rapidly stirring the acetic anhydride mixture. After the addition, continue to stir rapidly for 3 hours. Thereafter, pour the entire reaction mixture into 7200 milliliters of ice water,

CHAPTER 15: THE PREPARATION OF NITRATE ESTER NITRAMINES

and then filter-off the precipitated DINA. Then wash the DINA with 700 milliliters of cold water, and then vacuum dry or air-dry the product. After which, dissolve the dry crude DINA into 2400 milliliters of acetone, and then mix a potassium carbonate solution with the acetone mixture. The potassium carbonate solution is prepared by dissolving 7 grams of potassium carbonate into 96 milliliters of water. Then stir the mixture for ten minutes. A color change will develop during the addition of the potassium carbonate. After stirring for ten minutes, filter the solution to remove any insoluble impurities and then pour the entire filtered acetone mixture into 6400 milliliters of ice water, slowly, over a period of 3 hours while rapidly stirring the ice water. During this addition, the DINA will precipitate. After the addition, continue to rapidly stir the mixture for 3 hours. Thereafter, store the mixture in a refrigerator at 0 Celsius overnight. The next day, filter-off the DINA crystals, wash with 800 milliliters of cold water, and then vacuum dry or air-dry the product. The result will be about 540 grams of relatively pure DINA.

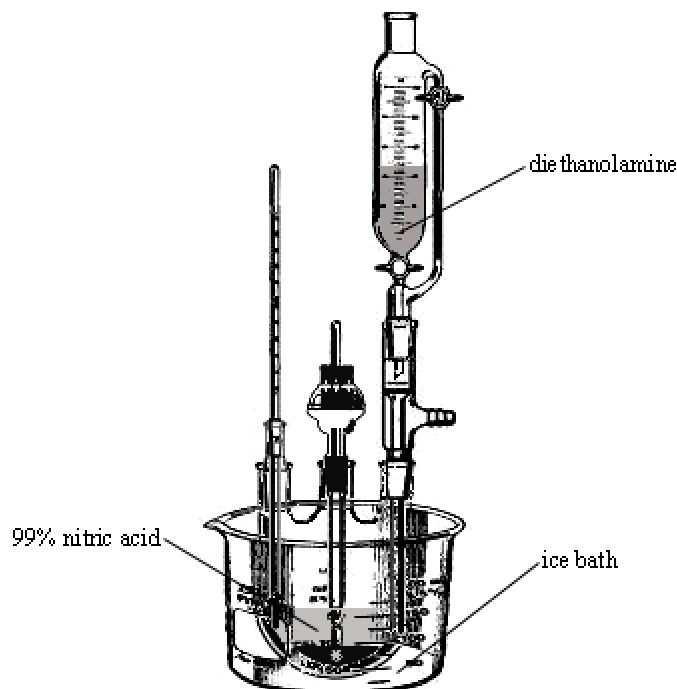

Figure 063. Apparatus for diethanolamine addition to nitric acid.

Notes:

Procedure 15-02C: Preparation of DINA

Materials:	1. 1908 grams 99% nitric acid
	2. 210 grams diethanolamine
	3. 73 grams anhydrous hydrogen chloride
	4. 200 milliliters 10% baking soda solution

Summary: DINA can be prepared by direct nitration of diethanolamine in the presence of hydrogen chloride. The reaction mixture is then heated, and upon completion of the reaction, the mixture is cooled and then mixed with ice. The precipitated product is then filtered-off, and then washed. Commercial & Industrial note: For related, or similar information, see Serial No. 570,814, December 30th, 1944, by Advisory Council for Scientific and Industrial Research, to George F. Wright, Toronto, Ontario, Walter John Chute, Kentville, Nova Scotia, Canada. Part or parts of this laboratory process may be protected by international, and/or commercial/industrial processes. Before using this process to legally manufacture the mentioned explosive, with intent to sell, consult any protected commercial or industrial processes related to, similar to, or additional to, the process discussed in this procedure. This process may be used to legally prepare the mentioned explosive for laboratory, educational, or research purposes.

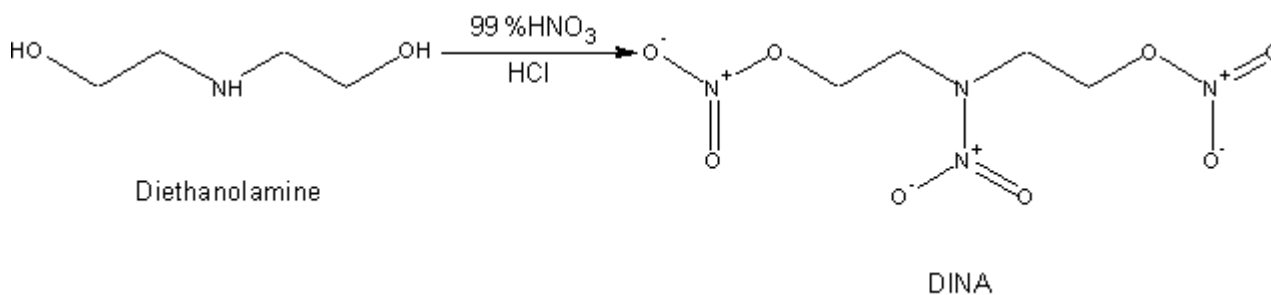
*Reaction Equation*

Hazards: Use maximum ventilation when handling 99% nitric acid. The acid is highly toxic and corrosive, and yields poisonous fumes of nitrogen oxides; use great care.

Procedure: Note: This procedure uses an excessive amount of 99% nitric acid to properly carry out the reaction. This excessive amount of acid can be recovered by treating the reaction mixture (after complete removal of the product) with methylene chloride to recover the nitric acid. Prior to this action, a small amount of sulfuric acid should be added to the reaction mixture. Afterwards, the reaction mixture should be extracted with several volumes of methylene chloride. These combined volumes can then be carefully distilled to recover the nitric acid of 99% purity (see nitric acid, 90% and 99% respectively).

Into a suitable flask, add 1908 grams of 99% nitric acid, and then cool the acid to 20 Celsius by means of a cold-water bath. Thereafter, gradually add drop-wise, 210 grams of diethanolamine over a period sufficient to keep the nitric acid at a temperature below 20 Celsius. During the addition, rapidly stir the nitric acid. After the addition, place the reaction mixture into an ice bath and chill to 0 Celsius. Thereafter, pass 73 grams of dry hydrogen chloride gas into the reaction mixture while stirring the reaction mixture, and maintaining its temperature below 5 Celsius. After the addition of the hydrogen chloride, heat the reaction mixture to 55 Celsius for 40 minutes. After 40 minutes, remove the heat source and allow the reaction mixture to cool to room temperature. Then, pour the entire reaction mixture onto 2000 grams of ice contained in a beaker. After much of the ice has melted, filter-off the precipitated DINA, wash with four 100-milliliter portions of cold water, 200 milliliters of 10% baking soda solution, and then with four 100 milliliter portions of cold water. After the washings, vacuum dry or air-dry the product. The result will be about 200 grams of dry product.

Notes:

15-03. DNAN. *Dinitroxydiethylamine nitrate*

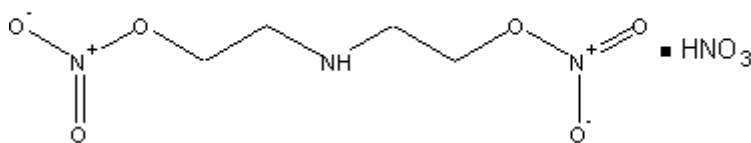

DNAN

DNAN forms colorless crystals with a melting point of 120 Celsius. It is fairly soluble in hot water, hot ethanol, methanol, and acetone. It is less soluble in cold water, cold ethanol, and insoluble in chloroform, benzene, ether, and petroleum ether. DNAN is somewhat hygroscopic, and moisture slowly decomposes it—should be stored in a desiccator. A small sample burns leaving a residue of carbon when ignited—a small sample can be detonated by the blow of a hammer. DNAN can be used in explosive compositions when alloyed with TNT, or other low melting secondary explosives, gun propellants with nitrocellulose, nitro starch, or nitroglycerine, and rocket propellants when mixed with ammonium perchlorate. DNAN also demonstrates usefulness for priming mixtures with lead azide, lead styphnate, or diazodinitrophenol, and for use in fireworks.

Molecular weight: 258.143

Flammability: Flashes when ignited

Detonating velocity: 7100 (estimated)	Toxicity: Low
Sensitivity: Moderate	Classification: Secondary explosive
Stability: Good	Overall value (as secondary explosive): Moderate

Procedure 15-03A: Preparation of DNAN

Materials:	1. 7560 grams 99% nitric acid
	2. 840 grams diethanolamine
	3. 600 milliliters 95% ethanol
	4. 400 milliliters ether
	5. 5000 milliliters acetone

Summary: DNAN can be prepared by carefully nitrating diethanolamine with 99% nitric acid. After the reaction, the mixture is treated with ice, the precipitate filtered-off, and then washed. The product should be washed and dried as fast as possible to decrease decomposition of the product. Commercial & Industrial note: Part or parts of this laboratory process may be protected by international, and/or commercial/industrial processes. Before using this process to legally manufacture the mentioned explosive, with intent to sell, consult any protected commercial or industrial processes related to, similar to, or additional to, the process discussed in this procedure. This process may be used to legally prepare the mentioned explosive for laboratory, educational, or research purposes.

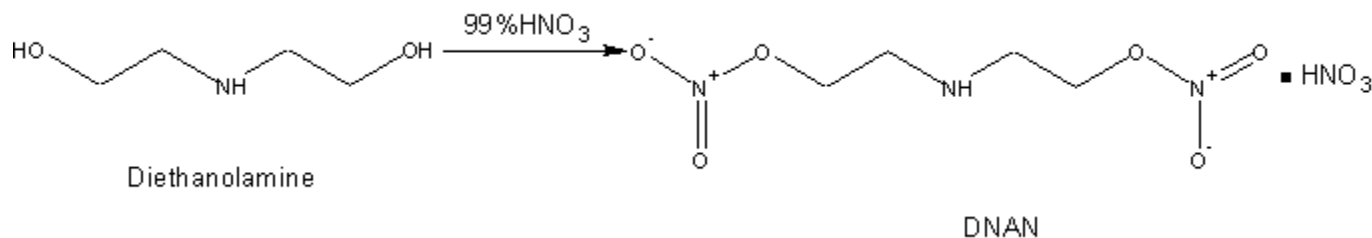

Reaction Equation

Hazards: Use maximum ventilation when handling 99% nitric acid. This acid is highly toxic and corrosive, and yields poisonous fumes of nitrogen oxides, use great care. Extinguish all flames before using 95% ethanol, ether, and acetone. Avoid inhalation of the vapors, and perform the peroxide test before using ether.

Procedure: Note: This procedure uses an excessive amount of 99% nitric acid to properly carryout the reaction. This excessive amount of acid can be recovered by treating the reaction mixture (after complete removal of the product) with methylene chloride to recover the nitric acid. Prior to this action, a small amount of sulfuric acid should be added to the reaction mixture. Afterwards, the reaction mixture should be extracted with several volumes of methylene chloride. These combined volumes can then be carefully distilled to recover the nitric acid of 99% purity (see nitric acid, 90% and 99% respectively).

Into a large 3-neck flask fitted with a motorized stirrer, add 7560 grams of 99% nitric acid. Then cool this nitric acid to 10 Celsius by means of an ice bath. Thereafter, gradually add 840 grams of diethanolamine over a period of 5 hours while rapidly stirring the nitric acid. After the addition, remove the ice bath, and heat the mixture to 40 Celsius for 2 hours while stirring. Note: during the heating period, a drying tube filled with anhydrous magnesium sulfate should be attached to the flask to exclude moisture. After the heating period, pour the reaction mixture onto 8 kilograms of ice contained in a beaker. Immediately thereafter, filter-off the precipitated product, and despite any presence of ice, wash the precipitated product with 1000 milliliters of ice water, then 600 milliliters of 95% ethanol, and finally with 400 milliliters of ether. Immediately after the washing, vacuum dry the solid product. Then recrystallize the product from 5000 milliliters of acetone (more acetone may be needed to completely dissolve the solid; depending on the initial purity). After collecting the crystals, vacuum dry, and then store the crystals in a desiccator filled with anhydrous magnesium sulfate until use.

Notes:

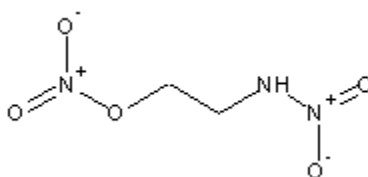
15-04. NENA. *N-(2-Nitroxyethyl)nitramine*

NENA

NENA forms a colorless or slightly yellow liquid with a melting point of 15 Celsius—should be stored in a refrigerator where it forms colorless crystals. It can be gently heated to 360 Celsius without detonation, but it begins to volatilize around 150 Celsius. NENA is more powerful than TNT, and has an excellent degree of stability and resistance to shock, heat, and percussion. It has applications in nitroglycerine free dynamites when mixed with propylene glycol or other glycols (to lower freezing point), blasting compositions with nitroglycerine or when mixed with TNT, RDX, HMX, or other secondary explosives, and rocket propellants when mixed with ammonium perchlorate, nitrocellulose, or nitro starch. NENA can also be used in making flexible sheet explosives with RDX and a high-energy plasticizer. NENA is acidic, and can form many salts with carbonates. The most common metal salt of NENA is silver NENA, but other salts such as the sodium, potassium, magnesium, copper, lead, zinc, and iron salts have been prepared. Metal salts of NENA are primary explosives, all of which detonate readily.

Molecular weight: 151.078	Flammability: May burn with smoky flame
Detonating velocity: Similar to TNT	Toxicity: Low
Sensitivity: Low	Classification: Secondary explosive
Stability: Good	Overall value (as secondary explosive): Moderate

Procedure 15-04A: Preparation of NENA

Materials:	1. 488 grams ethanolamine
	2. 5600 milliliters diethyl ether
	3. 868 grams ethyl chlorocarbonate
	4. 320 grams sodium hydroxide
	5. 350 grams anhydrous magnesium sulfate
	6. 500 milliliters 99% nitric acid
	7. 30 grams anhydrous ammonia
	8. 22 milliliters 98% sulfuric acid

Summary: NENA is prepared in a 4-step process starting with the preparation of a urethane intermediate. This intermediate is prepared by treating ethanolamine with ethyl chlorocarbonate in the presence of sodium hydroxide. The chemical reaction takes place in ether. After the reaction, the ether layer is separated, evaporated, and the resulting residue distilled under vacuum to remove the liquid urethane intermediate. The urethane intermediate is then nitrated with 99% nitric acid, and the resulting mixture is then separated, extracted with ether, and the ether solution is saturated with dry ammonia gas. The ammonia causes the precipitation of the ammonium salt, which is then filtered-off, washed, and dried. The ammonium salt is then neutralized by treatment with concentrated sulfuric acid. The resulting mixture is then separated, dried, and then vacuum distilled to remove the ether. The resulting pale yellow liquid is then removed, and stored in an appropriate bottle. Commercial & Industrial note: For related, or similar information, see Serial No. 570,806, December 30th, 1944, by The United States Navy, to Alfred T. Blomquist, and Fred T. Fledorek, Ithaca, NY. Part or parts of this laboratory process may be protected by international, and/or commercial/industrial processes. Before using this process to legally manufacture the mentioned explosive, with intent to sell, consult any protected commercial or industrial processes related to, similar to, or additional to, the process discussed in this procedure. This process may be used to legally prepare the mentioned explosive for laboratory, educational, or research purposes.

Hazards: Wear gloves and use proper ventilation when handling 99% nitric acid. The acid evolves poisonous fumes of nitrogen oxide, so avoid inhalation or skin contact. Use proper ventilation when handling diethyl ether, which is highly volatile. Avoid inhalation of vapors, and perform the peroxide test before using. Use proper ventilation when handling anhydrous ammonia, and avoid inhalation of vapors as well. Wear gloves when handling ethyl chlorocarbonate, 98% sulfuric acid, and

sodium hydroxide; all of which are corrosive. Do handle NENA with bare hands. Skin absorption or contact may lead to irritation and inflammation.

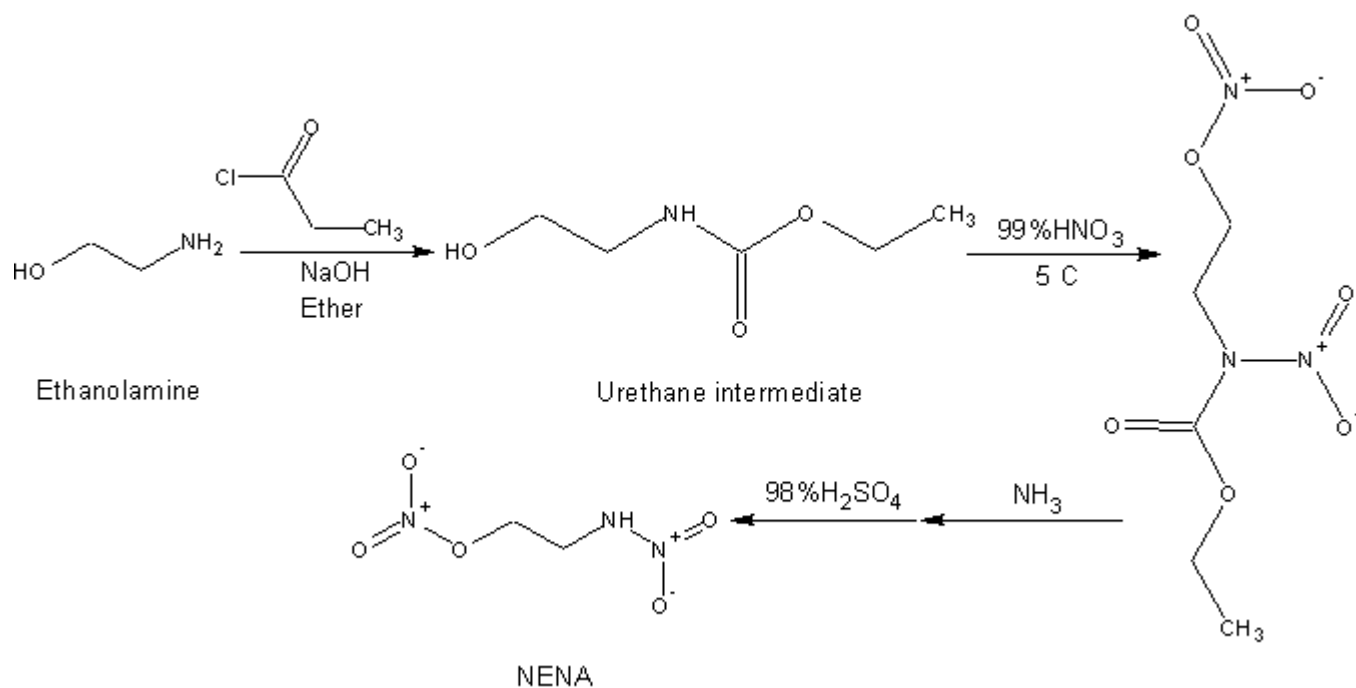

Reaction Equation

Procedure:

Step 1: Preparation of the urethane intermediate

Into a suitable 3-neck flask equipped with a motorized stirrer, thermometer, and two dropping funnels, place 488 grams of ethanolamine, 1200 milliliter of water, and then 1500 milliliters of diethyl ether. Then cool this mixture to about 5 Celsius by means of an ice bath. Thereafter, place 434 grams of ethyl chloroformate into funnel 1, and then slowly add, drop wise, at a rate sufficient to keep the reaction mixture at 5 Celsius. During the addition, rapidly stir the reaction mixture. After the addition, add 434 grams of additional ethyl chloroformate into funnel 1, and then place a sodium hydroxide solution prepared by dissolving 320 grams of sodium hydroxide into 1200 milliliters of water (wait for the solution to cool before using) into funnel 2. Thereafter, add the ethyl chloroformate and sodium hydroxide solution simultaneously drop wise, over a period sufficient to keep the reaction temperature at 5 Celsius. During the additions, rapidly stir the reaction mixture. After the additions, rapidly add 1000 milliliters of ether while stirring the reaction mixture, and then stir the reaction mixture for 1 hour. Then, decant the upper ether layer, and then extract the bottom water layer with sixteen 100-milliliter portions of ether. After the extraction, combine all ether layers, if not already done so, and then add 100 grams of anhydrous magnesium sulfate and stir for ten minutes. Then, filter-off the magnesium sulfate, and then place the ether mixture into a distillation apparatus and distill-off the ether. When all the ether has been removed the result will be a residue. Then place this residue into a vacuum distillation apparatus, and distill-off the desired urethane product under a vacuum of 5 millimeters of mercury at 134 Celsius. The result will be 1020 grams of a colorless liquid product.

Step 2: Nitration of the urethane intermediate

Note: This procedure uses an excessive amount of 99% nitric acid to properly carryout the reaction. This excessive amount of acid can be recovered by treating the reaction mixture (after complete removal of the product) with methylene chloride to recover the nitric acid. Prior to this action, a small amount of sulfuric acid should be added to the reaction mixture. Afterwards, the reaction mixture should be extracted with several volumes of methylene chloride. These combined volumes can then be carefully distilled to recover the nitric acid of 99% purity (see nitric acid, 90% and 99% respectively).

Add 500 milliliters of 99% nitric acid into a 3-neck flask fitted with a motorized stirrer, and thermometer and a dropping funnel. Thereafter, cool the acid to about 5 Celsius by means of an ice bath. When the temperature reaches 5 Celsius, place 100 grams of the urethane derivative (obtained in step 1) into the dropping funnel and then add drop wise, to the nitric acid at a rate sufficient to keep the nitric acids temperature around 5 Celsius. During the addition, rapidly stir the nitric acid. After the

CHAPTER 15: THE PREPARATION OF NITRATE ESTER NITRAMINES

addition, stir the reaction mixture for 30 minutes at 5 celsius, and thereafter, pour the entire reaction mixture over 1500 grams of crushed ice contained in a suitable beaker. After much of the ice has melted, decant the upper liquid layer, and then mix 300 milliliters of 10% baking soda solution into the liquid with stirring for ten minutes. After which, filter-off the baking soda, and extract the liquid with six 250 milliliter portions of diethyl ether. Thereafter, dry this ether mixture over 150 grams of anhydrous magnesium sulfate while stirring for ten minutes. Then, filter-off the magnesium sulfate, and keep the resulting filtered ether mixture for step 3.

Step 3: Preparation of the ammonium salt of NENA

Place the ether mixture, obtained in step 2, into an ice water bath, and then pass 30 grams of anhydrous ammonia into the ether mixture while stirring the ether mixture rapidly. During the addition, the ammonium salt of NENA will precipitate. After the addition of the ammonia, continue to stir the reaction mixture rapidly for about 30 minutes. Thereafter, filter-off the precipitated product, wash with 200 milliliters of fresh dry ether, using the same washing portion several times, and then vacuum dry or air-dry the product. The result will be 122 grams of the ammonium salt with a melting point of 79 Celsius. Note: The ammonium salt slowly decomposes at room temperature, and the decomposition occurs faster in the presence of water.

Note: The ammonium salt is highly flammable and will flash when ignited.

Step 4: Preparation of NENA

Place 122 grams of the ammonium salt, prepared in step 3, into a suitable flask, and then place this flask into an ice bath at 5 Celsius. Then add 500 milliliters of ice-cold water. Rapidly stir the mixture to dissolve the ammonium salt in the water. As soon as the ammonium salt has dissolved, carefully but quickly add 22 milliliters of 98% sulfuric acid while rapidly stirring the reaction mixture. Note: a brilliant red color will develop. After the addition of the sulfuric acid, stir the reaction for ten minutes at 5 Celsius, and then remove the upper NENA layer. Then extract this upper layer with six portions of ether, starting with portions one and two with 150 milliliters of diethyl ether, followed by four 100-milliliter portions of diethyl ether. After the extraction, combine all ether portions, if not already done so, and then dry over 50 grams of anhydrous magnesium sulfate with stirring. Thereafter, filter-off the magnesium sulfate and then place the filtered mixture into a distillation apparatus or rotary evaporator, and evaporate-off the ether under mild vacuum. When most of the ether has been removed, increase the vacuum to 9 millimeters of mercury and heat to 100 Celsius to remove the last traces of solvent. After which, remove the oily liquid product, and store in an amber glass bottle.

Note: Salts of NENA can be prepared by mixing NENA with a powdered metal carbonate in ether, followed by filtration to recover the crystals of the corresponding NENA salt.

Notes:

15-05. Silver NENA. *N-(2-Nitroxyethyl) nitramine, silver salt*

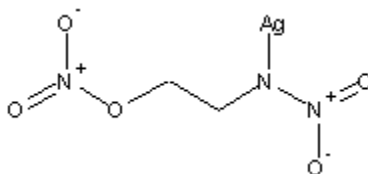

Silver NENA

Silver NENA forms a chalky white solid, which decomposes when heated to 120 Celsius. It darkens on exposure to light, and should be stored in amber glass bottles in a refrigerator. Silver NENA is used in blasting caps as a substitute for lead azide, diazodinitrophenol, or lead styphnate. It has applications for use in priming mixtures as a substitute for mercury fulminate or sulfur nitride, or admixed with sulfur nitride. Silver NENA should be desensitized by mixing with dextrose, starch, pectin, gelatin, or paraffins.

Molecular weight: 257.938

Flammability: Detonates when ignited

Detonating velocity: Uncalculated	Toxicity: Mild
Sensitivity: Above moderate	Classification: Primary explosive
Stability: Moderate	Overall value (as primary explosive): Moderate

Procedure 15-05A: Preparation of Silver NENA

Materials:	1. 85 grams silver nitrate
	2. 84 grams of ammonium salt of NENA (prepared in 15-04, step 3)
	3. 200 milliliters of 95% ethanol
	4. 200 milliliters dry diethyl ether.

Summary: The silver salt of NENA is easily prepared by mixing solutions of silver nitrate and ammonium NENA in water. The mixing of the two solutions causes the precipitation of the silver salt of NENA. The precipitate is then filtered-off, washed, and dried. Commercial & Industrial note: For related, or similar information, see Serial No. 570,806, December 30th, 1944, by The United States Navy, to Alfred T. Blomquist, and Fred T. Fledorek, Ithaca, NY. Part or parts of this laboratory process may be protected by international, and/or commercial/industrial processes. Before using this process to legally manufacture the mentioned explosive, with intent to sell, consult any protected commercial or industrial processes related to, similar to, or additional to, the process discussed in this procedure. This process may be used to legally prepare the mentioned explosive for laboratory, educational, or research purposes.

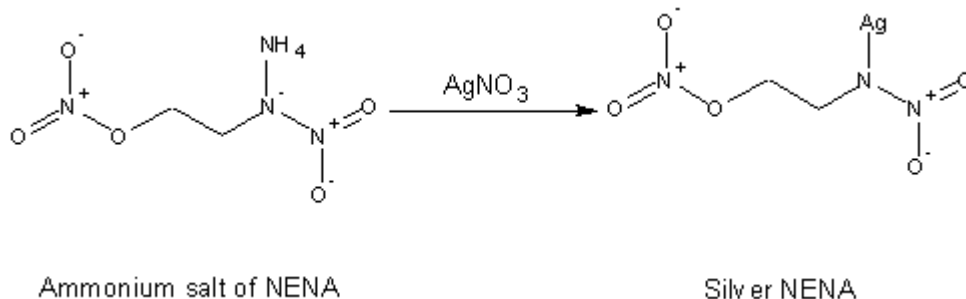

Reaction Equation

Hazards: Extinguish all flames, and use proper ventilation when handling diethyl ether and 95% ethanol. Avoid inhalation of the vapors.

Procedure: Prepare a solution by dissolving 85 grams of silver nitrate into 1000 milliliters of water. Then prepare another solution by dissolving 84 grams of the ammonium salt of NENA into 500 milliliters of ice-cold water. Immediately after the ammonium salt dissolves, add the silver nitrate solution moderately rapidly while rapidly stirring the ammonium salt solution. During the addition, a gummy precipitate will form, which will eventually give way to chalky white solid. After the addition, continue to stir the reaction mixture for about 20 minutes, and then filter-off the precipitated solid, wash with 200 milliliters of cold water, then with 200 milliliters of 95% ethanol, and followed by 200 milliliters of dry ether. After the washing vacuum dry or air-dry the product. The result will be about 124 grams of the product.

Notes:

CHAPTER 16: THE PREPARATION OF NITRO TRIAZOLES

NTA, MNTA, CDNTA, NTO, 5-NDTT

16-01. NTA. 3,5-Dinitro-1,2,4-triazole

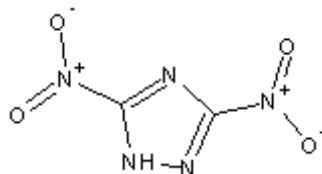

NTA

NTA forms hygroscopic crystals or powder, which are soluble in water, acetone, isopropyl alcohol, and ether. It is used in blasting caps and detonators when mixed with RDX, making demolition charges when admixed with nitrocellulose or nitro starch, and in priming mixtures with lead styphnate, lead azide, or diazodinitrophenol. NTA is acidic and readily forms salts with strong alkalis—all the salts of NTA are explosive, and are primary explosives. The salts of NTA can easily be prepared by precipitation of the corresponding salt with a base such as hydroxide or carbonate.

Molecular weight: 159.061	Flammability: May flash when strongly ignited
Detonating velocity: Uncalculated	Toxicity: Mild
Sensitivity: Moderate	Classification: Secondary explosive
Stability: Good	Overall value (as secondary explosive): High

Procedure 16-01A: Preparation of NTA

Materials:	1. 242 grams of 99% anhydrous hydrazine
	2. 800 grams of cyanogen bromide
	3. 1800 milliliters isopropyl alcohol
	4. 450 grams sodium nitrite
	5. 27 grams baking soda
	6. 152 grams copper nitrate trihydrate
	7. 300 milliliters 70% nitric acid
	8. 5000 milliliters of diethyl ether

Summary: NTA is prepared in a two-step process starting with the formation of guanazine hydrobromide. This intermediate is prepared by reacting 99% anhydrous hydrazine with cyanogen bromide. The resulting product is then precipitated by the addition of isopropyl alcohol, washed with additional alcohol, and dried. The guanazine hydrobromide is then treated with baking soda, followed by treatment with sodium nitrite and copper nitrate trihydrate. The resulting copper salt of dinitrotriazole is then filtered-off, and then acidified with 70% nitric acid. The resulting mixture containing the free acid dinitrotriazole compound is then extracted with diethyl ether, followed by evaporation of the ether to yield dry product. The product is then recrystallized from alcohol for purification. Commercial & Industrial note: For related, or similar information, see Serial No. 657,456, May 6th, 1957, by The United States Navy, to Richard H. Wiley, and Newton R. Smith, both of Louisville Ky. Part or parts of this laboratory process may be protected by international, and/or commercial/industrial processes. Before using this process to legally manufacture the mentioned explosive, with intent to sell, consult any protected commercial or industrial processes related to, similar to, or additional to, the process discussed in this procedure. This process may be used to legally prepare the mentioned explosive for laboratory, educational, or research purposes.

CHAPTER 16: THE PREPARATION OF NITRO TRIAZOLES

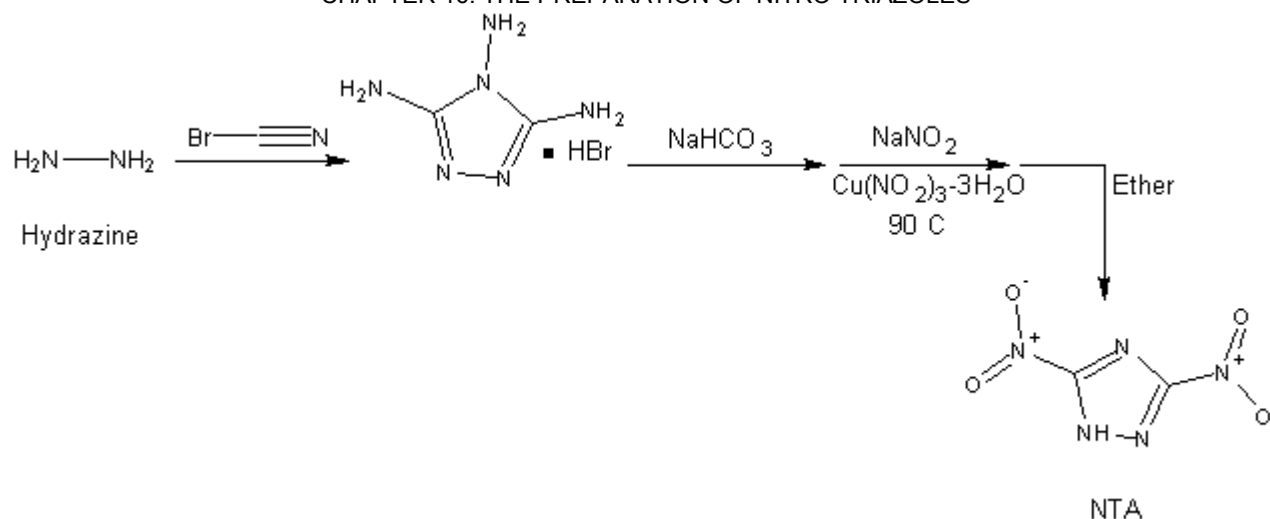
Reaction Equation

Hazards: Handle 99% anhydrous hydrazine with care. Never distill it in the presence of air, and keep it out of contact with strong oxidizers. Wear gloves, and use proper ventilation when handling cyanogen bromide. Cyanogen bromide is highly poisonous, and inhalation of vapors, or skin absorption can be fatal; toxic effects are similar to hydrogen cyanide (see The Preparatory Manual of Chemical Warfare agents). Wear gloves when handling 70% nitric acid. Use proper ventilation, and extinguish all flames before using ether. Avoid inhalation of ether vapors.

Procedure:

Step 1: Preparation of guanazine hydrobromide

Into a 3-neck flask equipped with a thermometer and motorized stirrer, place 600 milliliters of water, and then chill to about 5 Celsius in an ice bath. Afterwards, slowly add 242 grams of 99% anhydrous hydrazine while stirring the water. Then, carefully add 400 grams of cyanogen bromide over a period of 2 hours while stirring the reaction mixture, and maintain its temperature below 35 Celsius. After the addition, stir the reaction mixture for about 30 minutes, and then rapidly add another 400 grams of cyanogen bromide over a period of 30 minutes while rapidly stirring the reaction mixture and maintaining its temperature below 35 Celsius. After the addition, stir the reaction mixture for 4 hours, and then stop stirring, and allow the reaction mixture to stand for 24 hours. Then, add 400 milliliters of isopropyl alcohol, and then stir the reaction mixture for about 20 or 30 minutes. Thereafter, filter-off the precipitated product, wash with 400 milliliters of isopropyl alcohol, and then carefully vacuum dry, or air-dry the product. The result will be about 400 grams of guanazine hydrobromide with a decomposition point of 257 Celsius.

Step 2: Preparation of NTA

Into a 3-neck flask equipped with a motorized stirrer, thermometer, and gas outlet tube, place 450 grams of sodium nitrite, and then 600 milliliters of water. Then, rapidly stir the mixture while heating to 90 Celsius. This mixture will be designated solution A. Now, while solution A is being heated, prepare a second mixture, designated solution B, by placing 60 grams of guanazine hydrobromide into a beaker, and then add 150 milliliters of water. During the mixing, stir rapidly. After adding the water, add with stirring, 27 grams baking soda. Right after which, warm the solution to 30 or 40 Celsius until no more gas evolution takes place. While solution B is reacting, add 152 grams of copper nitrate trihydrate to solution A with rapid stirring. During the addition of the copper nitrate, keep solution A around 90 Celsius. Thereafter, add solution B, drop wise, to solution A while rapidly stirring solution A and maintaining its temperature around 90 Celsius. After the addition, continue to stir the reaction mixture for 90 minutes with stirring. After which, remove the heat source and allow the reaction mixture to cool to room temperature. Then filter-off the precipitated product, and then vacuum dry or air-dry. Next, take the dry filtered-off product, and place into a suitable beaker containing 300 milliliters of 70% nitric acid, and then allow this acid mixture to stand for about 2 hours. After 2 hours, extract the acid mixture with ten 500-milliliter portions of diethyl ether. After the extraction, combine all ether fractions, if not already done so, and then evaporate-off the ether using a rotary evaporator, or carefully distill-off the ether until dry solid remains. When dry solid remains, remove the solid from the flask, and then recrystallize from 1000 milliliters of isopropyl alcohol, and then vacuum dry or air-dry the product.

Notes:

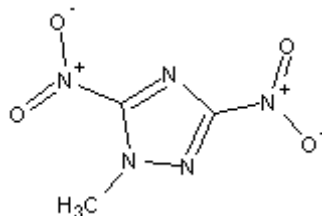
16-02. MNTA. 1-Methyl-3,5-dinitro-1,2,4-triazole

MNTA

MNTA forms white crystals with a melting point of 98 Celsius. The crystals detonate when heated to 400 Celsius. MNTA is relatively insensitive to shock, heat, and friction making it well suitable for explosives charges either by itself, or when alloyed with TNT, RDX, HMX, PETN, and many other secondary explosives. These explosive charges have much use in artillery shells, mortars, missile warheads, and demolition charges. MNTA can be used as an effective additive with ammonium perchlorate in rocket propellants along with aluminum powder or sodium borohydride. MNTA explosives charges should be initiated using a small tetryl booster.

Molecular weight: 173.088	Flammability: Burns with mild flame
Detonating velocity: 8000 (estimated)	Toxicity: Moderate
Sensitivity: Moderate	Classification: Secondary explosive
Stability: Good	Overall value (as secondary explosive): Moderate

Procedure 16-02A: Preparation of MNTA

Materials:	1. 242 grams of 99% anhydrous hydrazine
	2. 800 grams of cyanogens bromide
	3. 1200 milliliters isopropyl alcohol
	4. 450 grams sodium nitrite
	5. 200 grams baking soda
	6. 152 grams copper nitrate trihydrate
	7. 300 milliliters 70% nitric acid
	8. 1000 milliliters of diethyl ether
	9. 40 milliliters of dimethyl sulfate

Summary: MNTA is prepared in a two-step process starting with the formation of guanazine hydrobromide. This intermediate is prepared by reacting 99% anhydrous hydrazine with cyanogens bromide. The resulting product is then precipitated by the addition of isopropyl alcohol, washed with additional alcohol, and dried. The guanazine hydrobromide is then treated with baking soda, followed by treatment with sodium nitrite and copper nitrate trihydrate. The resulting copper salt of dinitrotriazole is then filtered-off, and then acidified with 70% nitric acid. The resulting mixture containing the free acid dinitrotriazole compound is then extracted with ether 5 times using the same 500-milliliter portion of ether. After each extraction, the free acid dinitrotriazole is neutralized with baking soda to form the corresponding sodium salt, which is later converted to the methyl derivative by treatment with dimethyl sulfate. The product is then allowed to separate, where it is then filtered-off, washed, and dried. The resulting dry product is then purified by recrystallization from isopropyl alcohol. Commercial & Industrial note: For related, or similar information, see Serial No. 656,993, May 3, 1957, by The United States Navy, to Newton Rosser Smith, and Richard Haven Wiley, both of Louisville, KY. Part or parts of this laboratory process may be protected by international, and/or commercial/industrial processes. Before using this process to legally manufacture the mentioned explosive, with intent to sell, consult any protected commercial or industrial processes related to, similar to, or additional to, the process discussed in this procedure. This process may be used to legally prepare the mentioned explosive for laboratory, educational, or research purposes.

CHAPTER 16: THE PREPARATION OF NITRO TRIAZOLES

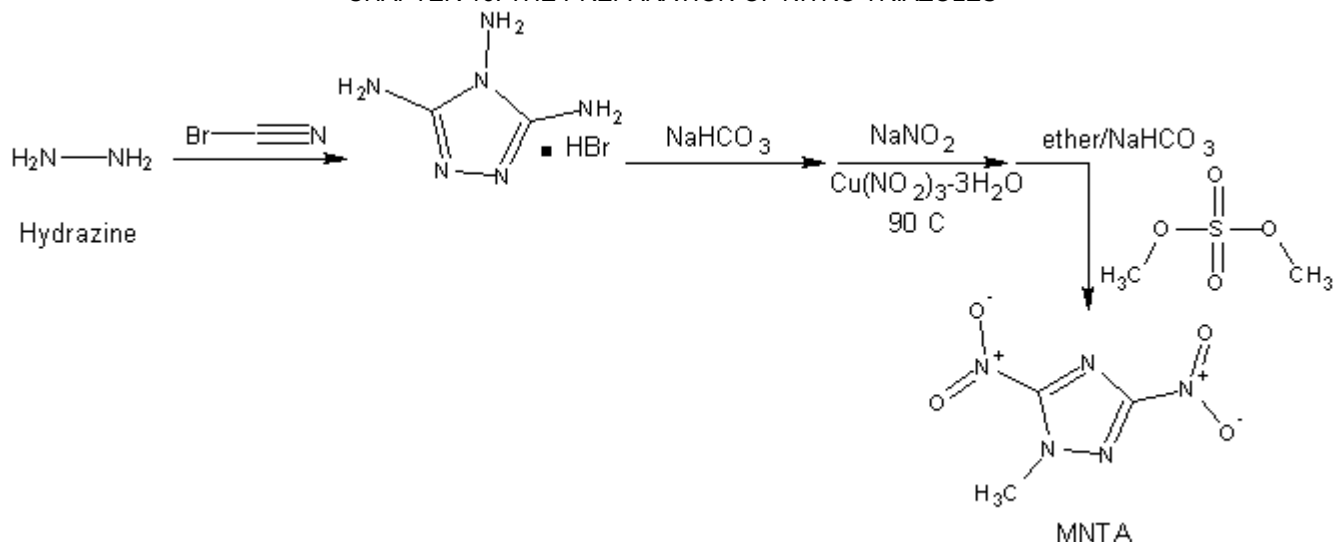
Reaction Equation

Hazards: Handle 99% anhydrous hydrazine with care. Never distill it in the presence of air, and keep it out of contact with strong oxidizers. Wear gloves, and use proper ventilation when handling cyanogen bromide. Cyanogen bromide is highly poisonous, and inhalation of vapors, or skin absorption can be fatal; toxic effects are similar to hydrogen cyanide. Wear gloves when handling 70% nitric acid. Use proper ventilation, and extinguish all flames before using ether. Avoid inhalation of ether vapors. Wear gloves when handling dimethyl sulfate. Dimethyl sulfate is toxic by skin absorption, inhalation or ingestion. Dimethyl sulfate is rapidly absorbed by the skin so use care.

Procedure:

Step 1: Preparation of guanazine hydrobromide

Into a 3-neck flask equipped with a thermometer and motorized stirrer, place 600 milliliters of water, and then chill to about 5 Celsius in an ice bath. Afterwards, slowly add 242 grams of 99% anhydrous hydrazine while stirring the water. Then, carefully add 400 grams of cyanogen bromide over a period of 2 hours while stirring the reaction mixture, and maintain its temperature below 35 Celsius. After the addition, stir the reaction mixture for about 30 minutes, and then rapidly add another 400 grams of cyanogen bromide over a period of 30 minutes while rapidly stirring the reaction mixture and maintaining its temperature below 35 Celsius. After the addition, stir the reaction mixture for 2 hours, and then stop stirring, and allow the reaction mixture to stand for 12 hours. Then, add 400 milliliters of isopropyl alcohol, and then stir the reaction mixture for about 20 or 30 minutes. Thereafter, filter-off the precipitated product, wash with 400 milliliters of isopropyl alcohol, and then carefully vacuum dry, or air-dry the product. The result will be about 400 grams of guanazine hydrobromide with a decomposition point of 257 Celsius.

Step 2: Preparation of MNTA

Into a 3-neck flask equipped with a motorized stirrer, thermometer, and gas outlet tube, place 450 grams of sodium nitrite, and then 600 milliliters of water. Then, rapidly stir the mixture while heating to 90 Celsius. This mixture will be designated solution A. Now, while solution A is being heated, prepare a second mixture, designated solution B, by placing 60 grams of guanazine hydrobromide (prepared in step 1) into a beaker, and then add 150 milliliters of water. During the mixing, stir rapidly. After adding the water, add with stirring, 27 grams baking soda. Right after which, warm the solution to 30 or 40 Celsius until no more gas evolution takes place. While solution B is reacting, add 152 grams of copper nitrate trihydrate to solution A with rapid stirring. During the addition of the copper nitrate, keep solution A around 90 Celsius. Thereafter, add solution B, drop wise, to solution A while rapidly stirring solution A and maintaining its temperature around 90 Celsius. After the addition, continue to stir the reaction mixture for 90 minutes with stirring. After which, remove the heat source and allow the reaction mixture to cool to room temperature. Then filter-off the precipitated product, and then vacuum dry or air-dry. Next, take the dry filtered-off product, and place into a suitable beaker containing 300 milliliters of 70% nitric acid, and then allow this acid mixture to stand for about 4 hours. After 4 hours, thoroughly mix the acid mixture with one portion of 1000 milliliters of diethyl ether, and then mix an excess baking soda slurry, (prepared by mixing baking soda with water so that a liquidize mass, similar to the appearance of milk of magnesia, results), with the diethyl ether mixture until the evolution of carbon dioxide ceases. After which, decant the upper diethyl ether layer (keep the baking soda/water layer), and then extract the baking soda/water layer mixture 4 more times, using the same 1000 milliliter portion of diethyl ether (previously used),

CHAPTER 16: THE PREPARATION OF NITRO TRIAZOLES

each time mixing the diethyl ether extract with a fresh baking soda slurry, and then decanting the upper diethyl ether layer each time and saving the bottom baking soda/water mixture; in other words, use the same 1000 milliliter portion of diethyl ether for each extraction time, and save each baking soda/water layer. After extracting the 70% nitric acid mixture a total of five times, and removing the upper ether layer from the last extraction, combine all the baking soda/water portions, stir rapidly for ten minutes, and then filter-off the insoluble baking soda. After which, to the filtered liquid remaining in the flask after filtering-off the baking soda, add 40 milliliters of dimethyl sulfate while rapidly stirring the mixture. After the addition of the dimethyl sulfate, allow the mixture to stand for about 5 hours with no stirring at room temperature. After 5 hours, filter-off the precipitated product, wash with plenty of cold water, and then vacuum dry or air-dry the product. Purification is accomplished by recrystallization from 400 milliliters of isopropyl alcohol, washing the collected product with 200 milliliters of cold water, and then vacuum drying or air-drying the product. The result will be about 12 grams of high purity MNTA.

Notes:

16-03. CDNTA. 3,5-Dinitro-1,2,4-triazole-copper salt

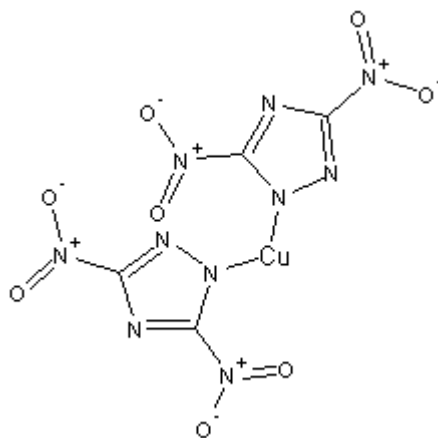

CDNTA

CDNTA form a white to bluish white powder, crystals, or granules. The crystals are sensitive to shock, friction, and percussion. CDNTA is a powerful primary explosive that demonstrates outstanding potential as a future replacement for mercury fulminate, lead styphnate, lead azide, and diazodinitrophenol for use in blasting caps and detonators. It should not be stored dry, and should be desensitized with dextrose, sulfur, starch, wood pulp, dextrin, or gum Arabic after preparation.

Molecular weight: 379.656	Flammability: Detonates when ignited
Detonating velocity: Uncalculated	Toxicity: Mild
Sensitivity: Above moderate	Classification: Primary explosive
Stability: Moderate	Overall value (as primary explosive): Moderate

Procedure 6A: Preparation of CDNTA

Materials:	1. 242 grams of 99% anhydrous hydrazine
	2. 800 grams of cyanogen bromide
	3. 1800 milliliters isopropyl alcohol
	4. 450 grams sodium nitrite
	5. 27 grams baking soda
	6. 152 grams copper nitrate trihydrate

Summary: CDNTA is prepared in a two-step process starting with the formation of guanazine hydrobromide. This intermediate is prepared by reacting 99% anhydrous hydrazine with cyanogen bromide. The resulting product is then precipitated by the addition of isopropyl alcohol, washed with additional alcohol, and dried. The guanazine hydrobromide is then treated with baking soda, followed by treatment with sodium nitrite and copper nitrate trihydrate. The resulting copper salt

CHAPTER 16: THE PREPARATION OF NITRO TRIAZOLES

of dinitrotriazole is then filtered-off, washed with cold water, and then dried. Commercial & Industrial note: Part or parts of this laboratory process may be protected by international, and/or commercial/industrial processes. Before using this process to legally manufacture the mentioned explosive, with intent to sell, consult any protected commercial or industrial processes related to, similar to, or additional to, the process discussed in this procedure. This process may be used to legally prepare the mentioned explosive for laboratory, educational, or research purposes.

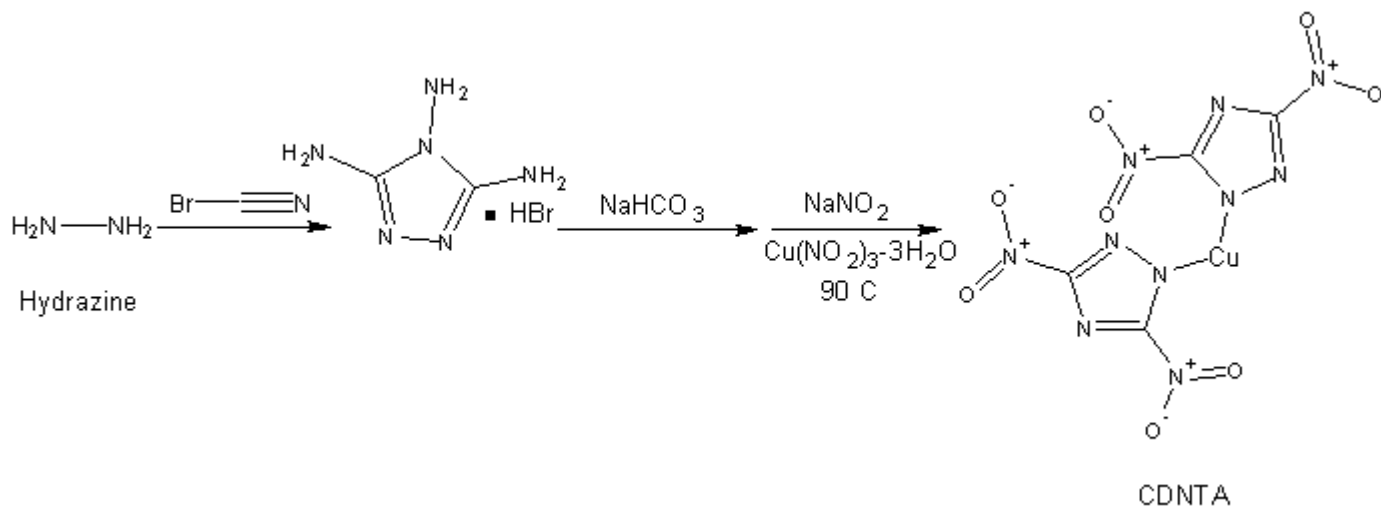

Reaction Equation

Hazards: Handle 99% anhydrous hydrazine with care. Never distill it in the presence of air, and keep it out of contact with strong oxidizers. Wear gloves, and use proper ventilation when handling cyanogen bromide. Cyanogen bromide is highly poisonous, and inhalation of vapors, or skin absorption can be fatal; toxic effects are similar to hydrogen cyanide.

Procedure:

Step 1: Preparation of guanazine hydrobromide

Into a 3-neck flask equipped with a thermometer and motorized stirrer, place 600 milliliters of water, and then chill to about 5 Celsius in an ice bath. Afterwards, slowly add 242 grams of 99% anhydrous hydrazine while stirring the water. Then, carefully add 400 grams of cyanogen bromide over a period of 2 hours while stirring the reaction mixture, and maintain its temperature below 35 Celsius. After the addition, stir the reaction mixture for about 30 minutes, and then rapidly add another 400 grams of cyanogen bromide over a period of 30 minutes while rapidly stirring the reaction mixture and maintaining its temperature below 35 Celsius. After the addition, stir the reaction mixture for 4 hours, and then stop stirring, and allow the reaction mixture to stand for 12 hours. Then, add 400 milliliters of isopropyl alcohol, and then stir the reaction mixture for about 20 or 30 minutes. Thereafter, filter-off the precipitated product, wash with 400 milliliters of isopropyl alcohol, and then carefully vacuum dry, or air-dry the product. The result will be about 400 grams of guanazine hydrobromide with a decomposition point of 257 Celsius.

Step 2: Preparation of CDNTA

Into a 3-neck flask equipped with a motorized stirrer, thermometer, and gas outlet tube, place 450 grams of sodium nitrite, and then 600 milliliters of water. Then, rapidly stir the mixture while heating to 90 Celsius. This mixture will be designated solution A. Now, while solution A is being heated, prepare a second mixture, designated solution B, by placing 60 grams of guanazine hydrobromide into a beaker, and then add 150 milliliters of water. During the mixing, stir rapidly. After adding the water, add with stirring, 27 grams baking soda. Right after which, warm the solution to 30 or 40 Celsius until no more gas evolution takes place. While solution B is reacting, add 152 grams of copper nitrate trihydrate to solution A with rapid stirring. During the addition of the copper nitrate, keep solution A around 90 Celsius. Thereafter, add solution B, drop wise, to solution A while rapidly stirring solution A and maintaining its temperature around 90 Celsius. After the addition, continue to stir the reaction mixture for 180 minutes with stirring. After which, remove the heat source and allow the reaction mixture to cool to room temperature. Then filter-off the precipitated product, wash with 500 milliliters of cold water, and then vacuum dry or air-dry the product.

Notes:

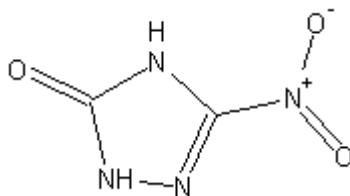
16-04. NTO. 3-nitro-1,2,4-triazol-5-one

NTO

NTO is a white crystalline compound, which is moderately soluble in water giving a yellow solution. It is relatively acidic, and forms stable salts with many metals—most of these salts are capable of deflagrating, and the heavy metal salts are primary explosives, which easily detonate. The potassium, sodium, and lithium salts of NTO are prepared by condensing NTO with a strong base such as the hydroxide or carbonate. The ammonium and diamine salts have also been prepared from the corresponding ammonia and amino compounds. NTO is highly resistant to shock, friction, and percussion and is more stable overall than RDX. NTO is somewhat expensive to manufacture, but the cost is outweighed by its remarkable performance as a high explosive. It can be alloyed with many secondary explosives for use in a wide variety of explosives charges. It can also be used in high performance gun propellants with nitroglycerine or nitrocellulose, and in rocket propellants with nitromethane and hydrazine, or ammonium perchlorate and a powdered metal. Salts of NTO are prepared by treating NTO with a powdered metal carbonate in ether, followed by addition of 95% ethanol.

Molecular weight: 130.063	Flammability: May burn with mild smoke
Detonating velocity: 8600	Toxicity: Mild
Sensitivity: Low	Classification: Secondary explosive
Stability: Good	Overall value (as secondary explosive): Moderate

Procedure 16-04A: Preparation of NTO

Materials:	1. 446 grams semicarbazide hydrochloride
	2. 460 milliliters 85% formic acid
	3. 1000 milliliters 70% nitric acid

Summary: NTO is prepared by a two-step process starting with the preparation of TO (1,2,4-triazol-5-one). This intermediate is prepared by the action of semicarbazide hydrochloride with formic acid. TO is then nitrated with 70% nitric acid to produce NTO. Commercial & Industrial note: For related, or similar information, see Application No. 009,165, January 30, 1987, by The United States of America, to Kien-Yin Lee, Los Alamos, NM, Michael D. Coburn, Los Alamos, NM. Part or parts of this laboratory process may be protected by international, and/or commercial/industrial processes. Before using this process to legally manufacture the mentioned explosive, with intent to sell, consult any protected commercial or industrial processes related to, similar to, or additional to, the process discussed in this procedure. This process may be used to legally prepare the mentioned explosive for laboratory, educational, or research purposes.

Hazards: Use proper ventilation when carrying out the reaction as hazardous fumes are produced. 70% Nitric acid is highly corrosive and toxic, so wear gloves when handling.

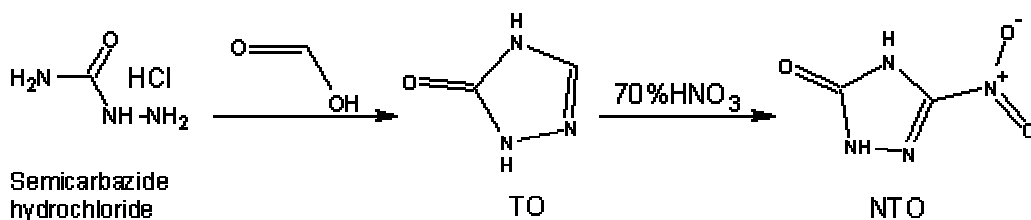

*Reaction Equation***Procedure:**

Step 1: Preparation of TO

Place 460 milliliters of 85% formic acid and 446 grams of semicarbazide hydrochloride into a flask, and then heat the mixture to 50 Celsius while stirring until all of the semicarbazide hydrochloride has dissolved. After the semicarbazide has dissolved, distill the mixture at 100 Celsius to remove excess formic acid, and continue the distillation until precipitation of a solid begins. When precipitation begins, rapidly add 600 milliliters of water to the flask, and continue the distillation at 100 Celsius until the solid contents in the flask are near dryness. After which, remove the heat source, and allow the mixture to cool to room temperature.

Step 2: Preparation of NTO

Slowly add 1000 milliliters of 70% nitric acid to the cooled flask containing the TO mixture (prepared in step 1). After the addition of the 70% nitric acid, heat the resulting mixture with strong stirring to 55 Celsius for 40 minutes. The reaction is exothermic (heat produced) and brown fumes evolve (be careful that the reaction temperature does not go above 55 Celsius. If the temperature begins to climb over 55 Celsius, remove the heat source until the reaction mixture temperature reduces). After 40 minutes, remove the heat source, and then cool the reaction mixture to 5 Celsius using an ice bath. Then keep at 5 Celsius for 1 hour, and then filter-off the precipitated product. Then wash the precipitated product with 200 milliliters of ice water, and then dry the NTO in an oven at 70 Celsius for approximately 24 hours.

Notes:

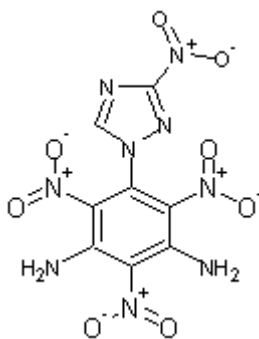
16-05. 5-NDTT. *5-nitro-2(3,5-diamino-2,4,6-trinitrophenyl)-1,2,4-triazole*

5-NDTT

Uses: Substitute for NTA or NTO, or in combination with for the preparation of explosives charges for use in a variety of applications including artillery shells, mortars, land mines, and missile warheads. Even though 5-NDTT is quite expensive to manufacture, it has excellent resistance to shock, friction, and percussion, making it very useful for the main component of high explosives especially for missiles.

Molecular weight: 354.175	Flammability: Burns with smoky flame
Detonating velocity: 8200 (estimated)	Toxicity: Moderate
Sensitivity: Low	Classification: secondary explosive
Stability: Good	Overall value (as secondary explosive): Moderate

Procedure 16-05A: Preparation of 5-NDTT

CHAPTER 16: THE PREPARATION OF NITRO TRIAZOLES

Materials:	1. 96 grams potassium nitrate
	2. 400 milliliters 30% fuming sulfuric acid
	3. 20 grams 1,3,5-trifluorobenzene
	4. 920 milliliters methylene chloride
	5. 600 milliliters hexane
	6. 5.5 grams tert-butylamine
	7. 100 milliliters trifluoroacetic acid
	8. 320 milliliters 1,2-dichloroethane
	9. 34 grams 3-amino-1,2,4-triazole
	10. 320 milliliters of glacial acetic acid
	11. 12 grams sodium nitrite
	12. 140 milliliters 98% sulfuric acid
	13. 400 milliliters of 10% sodium nitrite
	14. 24 grams urea
	15. 300 milliliters ethyl acetate
	16. 300 milliliters of dimethylformamide
	17. 200 milliliters diethyl ether
	18. 100 grams of anhydrous sodium sulfate
	19. 300 milliliters methanol

Summary: The high explosive 5-NDTT, is prepared in a three step process starting with the synthesis of 1-fluoro-3,5-diamino-2,4,6-trinitrobenzene. 1-fluoro-3,5-diamino-2,4,6-trinitrobenzene is then converted to 5-nitro-2(3,5-diamino-2,4,6-trinitrophenyl)-1,2,4-triazole by the reaction with 3-nitro-1,2,4-triazole. 5-NDTT is then collected by filtration, washed, and then dried. Commercial & Industrial note: For related, or similar information, see Application No. 280,555, December 6, 1988, by Commissariat a l'Energie Atomique, Paris, France, to Francois Laval, Monts, France, Pascal Vignane, Tours, FR. Part or parts of this laboratory process may be protected by international, and/or commercial/industrial processes. Before using this process to legally manufacture the mentioned explosive, with intent to sell, consult any protected commercial or industrial processes related to, similar to, or additional to, the process discussed in this procedure. This process may be used to legally prepare the mentioned explosive for laboratory, educational, or research purposes.

Hazards: Wear gloves and use proper ventilation when carrying out this reaction. Hexane, methylene chloride, 2-dichloroethane, diethyl ether, and ethyl acetate are highly flammable and volatile. Make sure there are no open flames. Use caution when handling 30% fuming sulfuric acid. 30% fuming sulfuric acid is highly toxic and corrosive. 98% Sulfuric acid is very corrosive so handle with care. Trifluoroacetic acid, and glacial acetic acid can cause skin burns. Use caution when handling tert-butylamine.

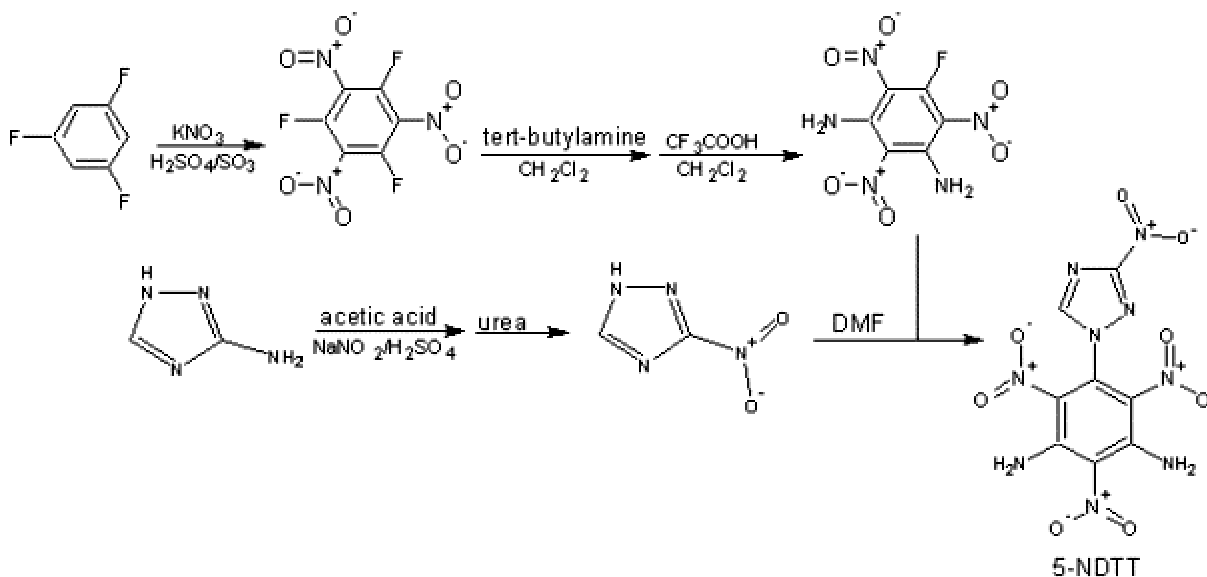

Reaction Equation

Procedure:

CHAPTER 16: THE PREPARATION OF NITRO TRIAZOLES

Step 1: Synthesis of 1-fluoro-3,5-diamino-2,4,6-trinitrobenzene (intermediate 1)

Place 400 milliliters of 30% fuming sulfuric acid into a beaker, and then cool to 10 Celsius by means of a cold water bath. Then gradually add 96 grams of finely ground potassium nitrate. Next, add 20 grams of 1,3,5-trifluorobenzene to the 30% fuming sulfuric acid mixture while rapidly stirring the 30% fuming sulfuric acid mixture. After the addition of the 1,3,5-trifluorobenzene, heat the reaction mixture to 156 Celsius, and continue heating for 3 days. After 3 days, cool the mixture to room temperature, and then extract the reaction mixture with 6 portions of 250 milliliters of methylene chloride. After extraction, combine the six extraction portions (if not already done so), and then add 100 grams of anhydrous sodium sulfate (to absorb water). Then stir the mixture for 1 hour. After 1 hour, filter off the sodium sulfate, and then concentrate the mixture by evaporating the methylene chloride just-to-the-point where a very small amount of solid begins to form on the surface (to do this without wasting any methylene chloride solvent, place the reaction mixture into a distillation apparatus, and distill off some of the methylene chloride at 40 Celsius). After concentration of the reaction mixture, remove the heat source and then allow the reaction mixture to cool to room temperature. Then add 600 milliliters of hexane. After the addition of the hexane, the 1,3,5-trifluoro-2,4,6-trinitrobenzene will precipitate. Then filter-off the precipitated product, and then vacuum dry or air-dry the product. The methylene chloride/hexane solvent mixture can be recycled by separation of both solvents using distillation.

To a 1000-milliliter flask equipped with a stirrer and a thermometer, place 5 grams of 1,3,5-trifluoro-2,4,6-trinitrobenzene (previously obtained), and 400 milliliters of methylene chloride. Then place the flask into a dry ice/acetone bath and cool the mixture to -30 Celsius. Afterwards, add 5.5 grams of tert-butylamine while stirring the reaction mixture and maintaining its temperature at -30 Celsius. After the addition of the tert-butylamine, remove the dry ice/acetone bath, and allow the temperature of the reaction mixture to rise to room temperature. Then, let the reaction mixture stand at room temperature while constantly stirring the reaction mixture for 30 hours (Keep the flask free from air by means of a water trap). After 30 hours, filter the reaction mixture to remove insoluble impurities, and then place the filtered mixture into a distillation apparatus and distill at 40 Celsius until dry solid remains. When dry solid is obtained, remove the heat source and allow the distillation flask to cool to room temperature. After which, collect the dry solid from the flask and mix it with a solution of trifluoroacetic acid and methylene chloride prepared by mixing 100 milliliters of trifluoroacetic acid with 20 milliliters of methylene chloride. After adding the collected solid to the trifluoroacetic acid and methylene chloride solution, stir the solution at room temperature for 40 hours. After 40 hours, add the mixture to 160 milliliters of 1,2-dichloroethane, and then place the mixture into a reflux apparatus and reflux the mixture at 50 Celsius for 30 minutes. After 30 minutes, allow the mixture to cool to room temperature and then place the mixture into a distillation apparatus and distill the mixture at 60 Celsius until only 150 milliliters of total volume remains. When this point is reached, remove the heat source and allow the mixture to cool to room temperature. Afterwards, filter-off the precipitated product, and then add the filtered-off precipitate to 160 milliliters of 1,2-dichloroethane. Then reflux the mixture for 30 minutes. After 30 minutes, allow the mixture to cool to room temperature, and then recrystallize the product from the 1,2-dichloroethane. Afterwards, vacuum dry or air-dry the product.

Step 2: Preparation of 3-nitro-1,2,4-triazole (intermediate 2)

Prepare a solution by adding 34 grams of 3-amino-1,2,4-triazole into 320 milliliters of glacial acetic acid. Prepare a second solution by adding 12 grams sodium nitrite into 140 milliliters of 98% sulfuric acid, and then cool this solution to 5 Celsius by means of an ice bath. Then, add the 3-amino-1,2,4-triazole/glacial acetic acid solution to the second solution while maintaining the temperature of the second solution at 5 Celsius and stirring. After the addition, wait ten minutes and then cool 100 milliliters of water to 0 Celsius. Then add this cooled water to the reaction mixture slowly and drop wise. After the addition of the water, heat 400 milliliters of a 10% sodium nitrite solution to 50 Celsius. After which, add the entire reaction mixture to this 10% sodium nitrite solution, and then continue heating at 50 Celsius for 2 hours while stirring the reaction mixture. After 2 hours, continue heating at 50 Celsius and then add 12 milliliters of 98% sulfuric acid, followed by 24 grams of urea while stirring the reaction mixture. After the addition of the urea, remove the heat source and allow the reaction mixture to cool to room temperature. When the reaction mixture reaches room temperature, mix the entire reaction mixture with 300 milliliters of ethyl acetate, and then shake the mixture vigorously for ten minutes. Then allow the mixture to stand for 10 minutes, and then decant (remove) the upper ethyl acetate layer. When the upper ethyl acetate layer has been removed, place the ethyl acetate layer into a distillation apparatus and distill at 77 Celsius until dry solid remains (the distillation may have to be temporarily stopped several times in order to filter-off precipitated product). When all the ethyl acetate has been removed, remove the heat source and then collect the product, and cool it to room temperature (vacuum filter or air dry any filtered-off product obtained during the distillation, and then add it to the rest of the product). Then recrystallize the product from 300 milliliters of methanol, and then vacuum dry or air-dry the product.

Step 3: Synthesis of 5-nitro-2(3,5-diamino-2,4,6-trinitrophenyl)-1,2,4-triazole.

Place 300 milliliters of dimethylformamide (DMF) into a flask, and then add and dissolve 4.4 grams of 3-nitro-1,2,4-triazole (obtained in step 2) while stirring the DMF. Stir the DMF mixture for 1 hour at room temperature (while stirring, keep the flask sealed from the air). After 1 hour, place the mixture into a cold water bath, and then add 10 grams of 1-fluoro-3,5-diamino-

CHAPTER 16: THE PREPARATION OF NITRO TRIAZOLES

2,4,6-trinitrobenzene (obtained in step 1), while constantly stirring the mixture and keeping its temperature below 20 Celsius by means of the cold water bath. After the addition, stir the mixture for 24 hours (while stirring, keep the flask sealed from the air). After 24 hours, pour the entire reaction mixture into 1 liter of cold water (stir the water constantly), and then filter-off the product. Then, wash the product several times with 500 milliliters of cold water, and then with 200 milliliters (several times using the same 200 milliliter portion) of diethyl ether. After washing with diethyl ether, vacuum dry or air-dry the product. The result will be 13 grams of 5-nitro-2(3,5-diamino-2,4,6-trinitrophenyl)-1,2,4-triazole.

Notes:

CHAPTER 17: THE PREPARATION OF NITRO TETRAZOLES

SATP, CNTA, MNTA, LNTA, TADA

17-01. SATP. *di-Silver aminotetrazole perchlorate*

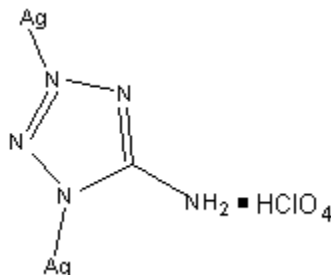

SATP

SATP forms colorless to white crystals that are stable up to 200 Celsius. The crystals are used as a substitute for lead azide, lead styphnate, or diazodinitrophenol for use in blasting caps and detonators. SATP is also used in place of mercury fulminate for priming compositions for use in bullet primers and the like—SATP is much more stable than lead azide, and it does not require desensitization for safe use. SATP is relatively stable, but it still easily detonates by heat, sparks, or flame and should be handled with care.

Molecular weight: 520.134	Flammability: Detonates when ignited
Detonating velocity: Uncalculated	Toxicity: Moderate
Sensitivity: Moderate	Classification: Primary explosive
Stability: Moderate	Overall value (as primary explosive): Moderate

Procedure 17-01A: Preparation of SATP

Materials:	1. 33 grams of silver perchlorate
	2. 16 grams 5-aminotetrazole
	3. 368 milliliters of 70% perchloric acid

Summary: SATP is prepared by reacting 5-aminotetrazole with silver perchlorate and concentrated perchloric acid. The reaction mixture is then diluted with water, which causes precipitation of the desired product. The SATP is then washed and dried. Commercial & Industrial note: For related, or similar information, see Serial No. 798,775, May 16th, 1972, by Unidynamics/Phoenix Company, to Charles T. Rittenhouse, Glendale, AZ. Part or parts of this laboratory process may be protected by international, and/or commercial/industrial processes. Before using this process to legally manufacture the mentioned explosive, with intent to sell, consult any protected commercial or industrial processes related to, similar to, or additional to, the process discussed in this procedure. This process may be used to legally prepare the mentioned explosive for laboratory, educational, or research purposes.

CHAPTER 17: THE PREPARATION OF NITRO TETRAZOLES

Materials:	1. 114 grams cupric sulfate
	2. 103 grams 5-aminotetrazole
	3. 196 milliliters of 98% sulfuric acid
	4. 154 grams of sodium nitrite

Summary: CNTA is prepared by the reaction of 5-aminotetrazole with sodium nitrite and sulfuric acid. The reaction mixture is kept cooled to 5 Celsius during the entire procedure. The product will be in the form of a gel, which is then purified by repeated washings with sulfuric acid, and water. Commercial & Industrial note: For related, or similar information, see Application No. 794,197, May 5, 1977, by The United States Navy, to William H. Gilligan, Washington, DC, Mortimer J. Kamlet, Silver Spring, MD. Part or parts of this laboratory process may be protected by international, and/or commercial/industrial processes. Before using this process to legally manufacture the mentioned explosive, with intent to sell, consult any protected commercial or industrial processes related to, similar to, or additional to, the process discussed in this procedure. This process may be used to legally prepare the mentioned explosive for laboratory, educational, or research purposes.

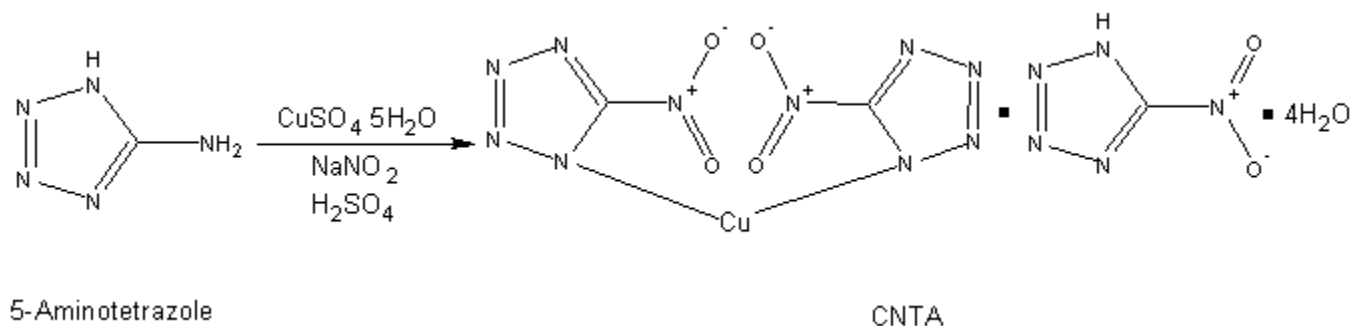

Reaction Equation

Hazards: Wear gloves when handling 98% sulfuric acid, and carry out the reaction using proper ventilation. Warning! The copper salt of 5-nitrotetrazole is a very dangerous substance. It will detonate on percussion, heat, or friction. CNTA can be unstable. Prepare in small quantities only, and use proper blast shielding. Store the pure substance submerged in a water free solvent such as benzene, toluene, mineral oil, or kerosene.

Procedure: Prepare a solution (solution A) by dissolving 154 grams of sodium nitrite, and 110 grams of cupric sulfate pentahydrate into 1500 milliliters of water, and then cool this solution to 5 Celsius by means of an ice bath. Prepare a second solution (solution B) by dissolving 103 grams of 5-aminotetrazole monohydrate, 4 grams of cupric sulfate pentahydrate, and 36 milliliters of 98% sulfuric acid into 3000 milliliters of water. Afterwards, add solution B slowly, and drop wise over a period of about 4 hours to solution A (constantly stir solution A during the addition of solution B). Maintain the temperature of solution A at 5 Celsius during the addition of solution B. After the addition of solution B to solution A, prepare a third solution (solution C) by dissolving 20 milliliters of 98% sulfuric acid into 200 milliliters of water. Now add solution C slowly, and drop wise to solution A while stirring and maintaining the temperature of solution A at 5 Celsius. Finally, prepare a fourth solution (solution D) by dissolving 90 milliliters of 98% sulfuric acid into 90 milliliters of water. Now, slowly add solution D drop wise to solution A (solution A will have the appearance of a slurry). After the addition of solution D to solution A, stir solution A for 1 hour, and then filter solution A to obtain the product. The product, the acid copper salt of 5-nitrotetrazole, will be in the form of a gel. Wash this gel product with 1000 milliliters (multiple times using the same 1000 milliliter fraction) of a sulfuric acid mixture prepared by dissolving 50 milliliters of 98% sulfuric acid into 1000 milliliters of water. Then wash with four 500-milliliter fractions of water (multiple times using the same 500 milliliter fraction each time). The washings should be conducted for a total of 12 hours to achieve good purity. After the washings, air-dry the product.

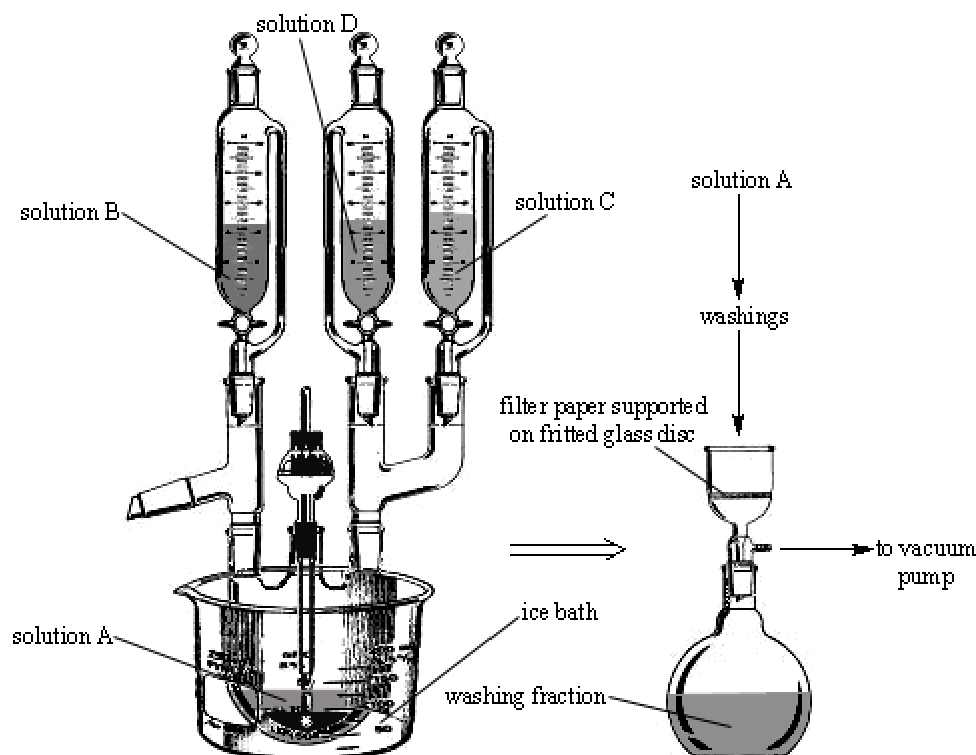
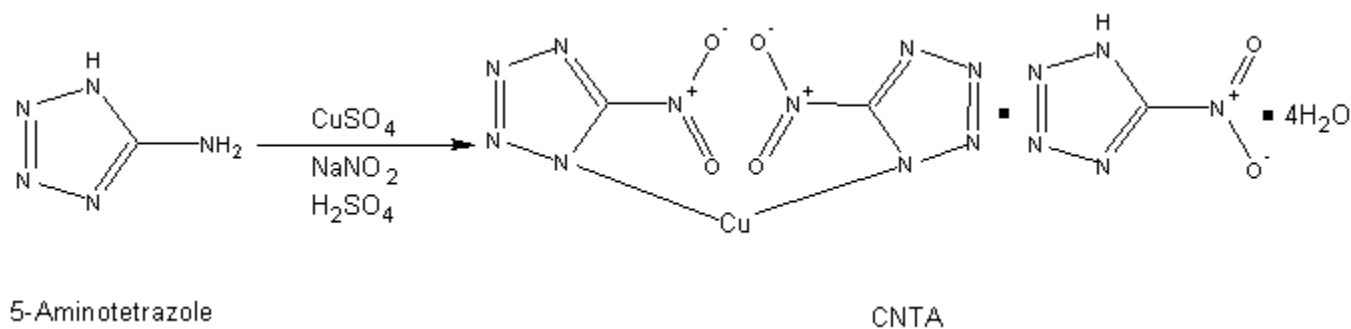

Figure 064. Setup for CNTA preparation.

Procedure 17-02B: Preparation of CNTA

Materials:	1. 200 grams anhydrous cupric sulfate
	2. 206 grams 5-aminotetrazole monohydrate
	3. 240 milliliters of 98% sulfuric acid
	4. 320 grams of sodium nitrite
	5. 400 milliliters of 25% sulfuric acid

Summary: CNTA is prepared by reacting 5-aminotetrazole with copper sulfate, and sodium nitrite in the presence of sulfuric acid. After the reaction, the mixture is cooled, and the product precipitates, forming a paste. The product is then vacuum filtered, washed, and dried. Commercial & Industrial note: For related, or similar information, see Serial No. 621,523, January 5th, 1937, by Edmund von Herz, Cologne, Germany. Part or parts of this laboratory process may be protected by international, and/or commercial/industrial processes. Before using this process to legally manufacture the mentioned explosive, with intent to sell, consult any protected commercial or industrial processes related to, similar to, or additional to, the process discussed in this procedure. This process may be used to legally prepare the mentioned explosive for laboratory, educational, or research purposes.

*Reaction Equation*

CHAPTER 17: THE PREPARATION OF NITRO TETRAZOLES

Hazards: Wear gloves when handling 98% sulfuric acid. 98% sulfuric acid is capable of dehydrating and/or dissolving many substances including cloths. Use caution. Warning! The copper salt of 5-nitroterazole is a very dangerous substance. It will detonate on percussion, heat, or friction. CNTA can be unstable. Prepare in small quantities only, and use proper blast shielding. Store the pure substance submerged in a water free solvent such as benzene, toluene, mineral oil, or kerosene.

Procedure: Prepare a solution by dissolving 206 grams of 5-aminotetrazole monohydrate, and 60 milliliters of 98% sulfuric acid into 4 liters of water. Prepare a second solution by dissolving 320 grams sodium nitrite, and 200 grams of anhydrous copper sulfate into 3 liters of water. Then cool this solution in a cold-water bath. Then slowly add the 5-aminotetrazole solution to the copper sulfate solution while rapidly stirring the copper sulfate solution and maintain its temperature below 20 Celsius. After the addition of about half of the 5-aminotetrazole solution, remove the cold water bath from the copper sulfate solution, and then continue the addition of the 5-aminotetrazole solution with constant stirring. Note: allow any temperature increase to happen, but not above 60 Celsius. Note: during the addition, nitrogen gas will be steadily evolved. After the addition, and after no more nitrogen is evolved, carefully add 180 milliliters of 98% sulfuric acid and continue stirring. After the acid addition, cool the reaction mixture with an ice water bath for 30 to minutes to 1 hour. The copper salt will precipitate as thin blue needles, and shortly the reaction mixture should take on the form of a paste. After the paste forms, vacuum filter the paste to collect the copper salt. Afterwards, wash the copper salt with 400 milliliters of 25% sulfuric acid, and then with large amounts of water. Afterwards, vacuum dry or air-dry the product.

Notes:

CNTA priming mixture

Into a crucible, place 8 grams of antimony pentasulfide, 14 grams of lead thiocyanate, and then 28 grams of potassium chlorate. Thereafter, thoroughly blend the mixture for 30 minutes using a wooden stir rod, or spoon. Make sure to avoid excessive friction during the mixing process. After blending for 30 minutes, add in 150 grams of freshly prepared, wet CNTA, and then continue the blending for about 1 hour to obtain a properly mixed and uniform mixture. Thereafter, place the paste onto a shallow pan, and allow it to cure for several days at room temperature. After which time, remove the dried material, and place into a roller mill filled with 200 grams of steel balls about 4 millimeters in diameter each ball, and then roller mill the priming mixture at a very low speed for several minutes until the priming mixture appears to be pulverized. Thereafter, pass the pulverized mass through a small wire mesh sieve (0.05 to 0.10 millimeters in diameter). For small primers, such as .22 calibers to 9 millimeters, 0.11 wire mesh sieves should be used. For larger primers, say, for .50 caliber bullets, the wire mesh sieves should be at least 0.50 millimeters in diameter. After the sifting process, simply pack the same sized granules of the priming mixture into any desirable, yet appropriate sized primer. Commercial & Industrial note: For related, or similar information, see Serial No. 699,472, February 8, 1985, by L'Etat Francais represente par le Delege Ministeriel pour L'Armement, to Jean Duguet, Tarbes, France. Part or parts of this process may be protected by international, and/or commercial/industrial processes. Before using this process to legally manufacture the mentioned priming mixture, with intent to sell, consult any protected commercial or industrial processes related to, similar to, or additional to, the process discussed in this procedure. This process may be used to legally prepare the mentioned explosive composition for laboratory, educational, or research purposes.

17-03. HGNTA. *Mercury nitrotetrazole*

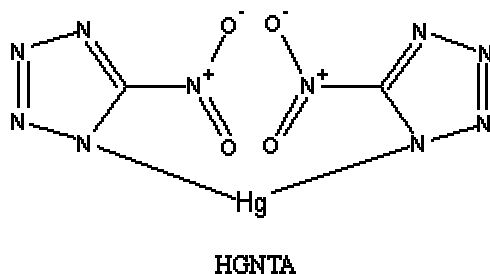

HGNTA forms heavy, granular crystals, which are not very soluble in water—the crystals are stable in nitric acid. HGNTA detonates when heated to 215 Celsius. Its percussion sensitivity is similar to mercury fulminate, and it's used in primers for bullets and the like. It can also be used in booster compositions in place of, or in combination with lead azide or

CHAPTER 17: THE PREPARATION OF NITRO TETRAZOLES

diazodinitrophenol for use in blasting caps, or detonators. HGNTA like most mercury salts are highly toxic, and should not be handled with bare hands. HGNTA should be desensitized with glucose, flour, cellulose, or finely divided carbon black immediately after preparation. The crystals can be stored for up to a week in a nitric acid solution (20% by weight). Note: Handle this substance with care as simply dropping a small sample onto a hard surface, dripping a liquid upon the surface of a sample, or hitting a small sample with a mild object such as a nail or screw may cause detonation.

Molecular weight: 428.678	Flammability: Detonates when ignited
Detonating velocity: 6300 (estimated) also estimated at 6550	Toxicity: High
Sensitivity: High	Classification: Primary explosive
Stability: Low	Overall value (as primary explosive): Moderate

Procedure 17-03A: Preparation of HGNTA

Materials:	1. 50 grams sodium hydroxide
	2. 200 grams of CNTA
	3. 140 grams mercury-II-nitrate hydrate
	4. 18 milliliters of 70% nitric acid

Summary: HGNTA is similar to CNTA in nature, and can be made by converting CNTA to the sodium salt, which is much more soluble in water. This sodium salt gives way to the insoluble mercury salt when treated with mercury nitrate in the presence of nitric acid. The precipitated mercury salt is then collected by filtration, washed, and dried. Commercial & Industrial note: Part or parts of this laboratory process may be protected by international, and/or commercial/industrial processes. Before using this process to legally manufacture the mentioned explosive, with intent to sell, consult any protected commercial or industrial processes related to, similar to, or additional to, the process discussed in this procedure. This process may be used to legally prepare the mentioned explosive for laboratory, educational, or research purposes.

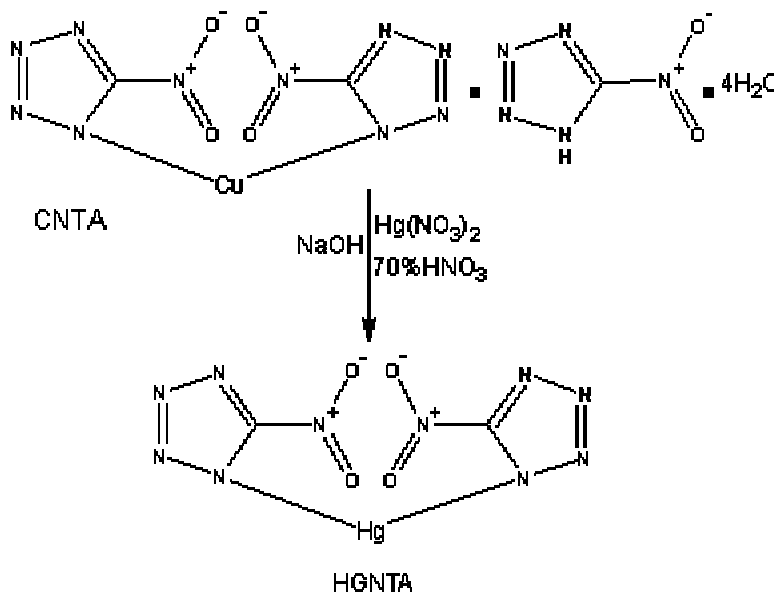

Reaction Equation

Hazards: Mercury-II-nitrate, and HGNTA are highly toxic; handle with care, and wear gloves when handling. Wear gloves when handling corrosive sodium hydroxide; solutions can cause skin burns. Note: Strong alkalis cause more severe skin burns than most strong acids.

Procedure:

Step 1: Preparation of sodium nitrotetrazole

CHAPTER 17: THE PREPARATION OF NITRO TETRAZOLES

Prepare a sodium hydroxide solution by dissolving 50 grams of sodium hydroxide into 150 milliliters of water. Then add 200 grams of dry CNTA into 1000 milliliters of water, and then carefully bring the mixture to a boil (100 Celsius). Afterwards, gradually add the sodium hydroxide solution over a period of about 10 minutes while stirring the CNTA water mixture. During the addition of the sodium hydroxide, a precipitate of copper oxide will form (Note: this copper oxide can be recycled back to copper sulfate by adding to dilute sulfuric acid, followed by recrystallization of the copper sulfate; for use in manufacturing another crop of CNTA). After the addition of the sodium hydroxide solution, remove the heat source and allow the reaction mixture to cool to room temperature. Then filter-off the insoluble copper oxide precipitate. Leave the filtered reaction mixture for the next step. The result will be a sodium nitrotetrazole solution.

Step 2: Preparation of HGNTA

Prepare a solution by dissolving 140 grams of mercury-II-nitrate hydrate, and 18 milliliters of 70% nitric acid into 1400 milliliters of water. Then filter this solution to remove any insoluble impurities. Afterwards, heat this solution to 70 Celsius. Thereafter, slowly add the sodium nitrotetrazole solution (prepared in step 2) over a period of 1 hour, while rapidly stirring the mercury-II-nitrate solution and keeping its temperature at 70 Celsius. After the addition, remove the heat source and allow the reaction mixture to cool to room temperature, during which time continue stirring. Then filter-off the precipitated mercury salt, wash with plenty of cold water, and then vacuum dry or air-dry the product. The result will be a fine granular product suitable for use in blasting caps and detonators.

Notes:

HGNTA priming mixture

This process is identical to the CNTA priming mixture, but with HGNTA being used instead. Into a crucible, place 8 grams of antimony pentasulfide, 14 grams of lead thiocyanate, and then 28 grams of potassium chlorate. Thereafter, thoroughly blend the mixture for 30 minutes using a wooden stir rod, or spoon. Make sure to avoid excessive friction during the mixing process. After blending for 30 minutes, add in 150 grams of freshly prepared, wet HGNTA, and then continue the blending for about 1 hour to obtain a properly mixed and uniform mixture. Thereafter, place the paste onto a shallow pan, and allow it to cure for several days at room temperature. After which time, remove the dried material, and place into a roller mill filled with 200 grams of steel balls about 4 millimeters in diameter each ball, and then roller mill the priming mixture at a very low speed for several minutes until the priming mixture appears to be pulverized. Thereafter, pass the pulverized mass through a small wire mesh sieve (0.05 to 0.10 millimeter in diameter). For small primers, such as .22 calibers to 9 millimeters, 0.11 wire mesh sieves should be used. For larger primers, say, for .50 caliber bullets, the wire mesh sieves should be at least 0.50 millimeters in diameter. After the sifting process, simply pack the same sized granules of the priming mixture into any desirable, yet appropriate sized primer. Commercial & Industrial note: For related, or similar information, see Application No. 699,472, February 8, 1985, by L'Etat Francais represente par le Delege Ministeriel pour L'Armement, to Jean Duguet, Tarbes, France. Part or parts of this process may be protected by international, and/or commercial/industrial processes. Before using this process to legally manufacture the mentioned priming mixture, with intent to sell, consult any protected commercial or industrial processes related to, similar to, or additional to, the process discussed in this procedure. This process may be used to legally prepare the mentioned explosive composition for laboratory, educational, or research purposes.

17-04. LNTA. *Lead nitrotetrazole, basic salt*

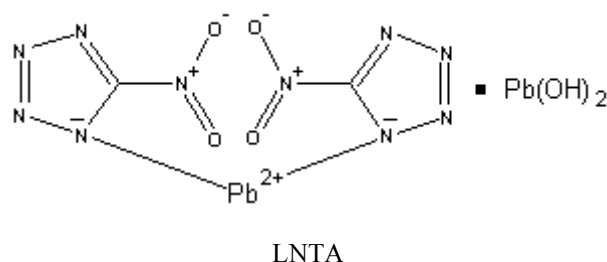

CHAPTER 17: THE PREPARATION OF NITRO TETRAZOLES

LNTA forms heavy, granular, yellowish white crystals, which are not very soluble in water—the crystals are more readily soluble in hot water. LNTA detonates when heated to 220 Celsius, and is slightly more percussion sensitive than mercury fulminate; as a result, its use in priming compositions has been questioned, but it can be safely desensitized by mixing with dextrose, flour, or gum Arabic immediately after preparation. The desensitized product can be successfully used in priming compositions for use in bullet primers and the like.

Molecular weight: 676.502	Flammability: Detonates when ignited
Detonating velocity: 6500 (estimated)	Toxicity: Moderate
Sensitivity: High	Classification: Primary explosive
Stability: Low	Overall value (as primary explosive): Moderate

Procedure 17-04A: Preparation of LNTA

Materials:	1. 200 grams of CNTA
	2. 14 grams of hydrogen sulfide
	3. 1200 milliliters of benzene
	4. 336 grams freshly precipitated lead-II-hydroxide

Summary: LNTA is prepared by converting CNTA into the free nitrotetrazole by treatment with hydrogen sulfide gas. The resulting reaction mixture is filtered, to remove the insoluble copper sulfide, and then evaporated to a syrupy liquid. This liquid is then extracted with benzene, and then evaporated to yield the free nitrotetrazole. The free nitrotetrazole is dissolved in water, and then precipitated as the basic lead salt by addition of freshly precipitated lead hydroxide, which is prepared by adding sodium hydroxide solution to a solution of lead-II-acetate (or prepared by mixing commercial lead hydroxide with hot water, followed by filtering, and vacuum drying. The precipitated lead nitrotetrazole is then collected by filtration, washed, and dried. Commercial & Industrial note: Part or parts of this laboratory process may be protected by international, and/or commercial/industrial processes. Before using this process to legally manufacture the mentioned explosive, with intent to sell, consult any protected commercial or industrial processes related to, similar to, or additional to, the process discussed in this procedure. This process may be used to legally prepare the mentioned explosive for laboratory, educational, or research purposes.

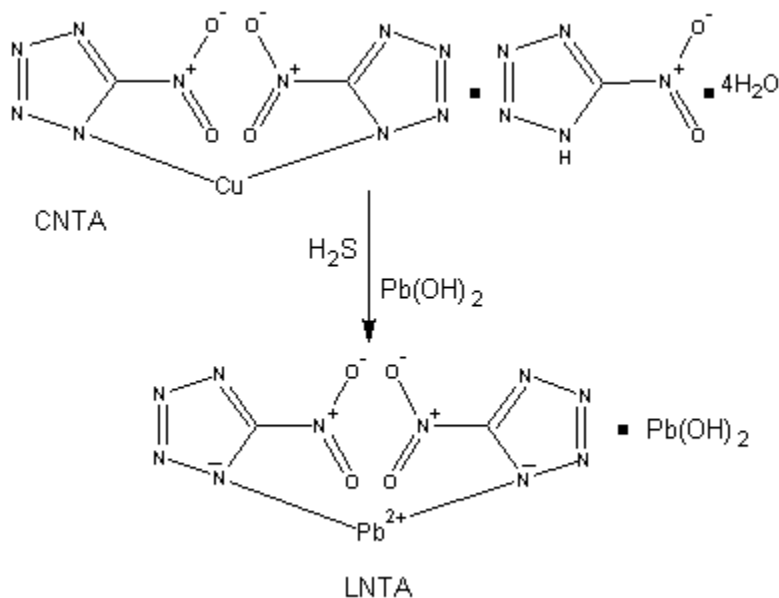

Reaction Equation

Hazards: Hydrogen sulfide is a poisonous gas. Use proper ventilation, and avoid inhalation. Wear gloves, and avoid inhalation of benzene vapors. Benzene is a known carcinogen. Free nitrotetrazole is a dangerous substance. It easily detonates by heat, sparks, percussion, or fire. Handle with great care. Note: Water solutions of the free nitrotetrazole are perfectly safe.

Procedure:

Step 1: Preparation of free nitrotetrazole

Prepare a CNTA suspension by adding 200 grams of CNTA into 800 milliliters of warm water. Afterwards, pass 14 grams of dry hydrogen sulfide into the CNTA suspension while stirring the CNTA suspension. During the addition, keep the temperature below 40 Celsius. (Note: A precipitate of copper sulfide will form. This salt can be converted back into the sulfate by roasting the sulfide in air until no more sulfur dioxide is evolved. The copper oxide is then digested into dilute sulfuric acid, followed by recrystallization to recover the copper sulfate pentahydrate). After the addition of the hydrogen sulfide, filter-off the precipitated copper sulfide, and then evaporate the reaction mixture until a syrupy consistency is obtained (use a rotary evaporator under moderately high vacuum; if one is not available, carefully boil-off the water at 100 Celsius). When a syrupy consistency is obtained, stop the evaporation process and allow the reaction to cool to room temperature. Then, extract the syrupy consistency with six 200-milliliter portions of benzene. After which, combine all benzene fractions (if not already done so), and then evaporate-off the benzene until dry solid remains (use a rotary evaporator under moderate vacuum). When dry solid remains, the result will be a white, very deliquescent mass, which is very explosive. The melting point of this mass cannot be accurately determined.

Step 2: Preparation of LNTA

Prepare a solution by dissolving 174 grams of free nitrotetrazole (prepared in step 1) into 1512 milliliters of water. Afterwards, heat this solution to 80 Celsius. When the temperature reaches 80 Celsius, quickly add 336 grams of freshly precipitated lead-II-hydroxide while rapidly stirring the hot mixture. After the addition of the lead hydroxide, rapidly filter the reaction mixture hot, and then allow the solution to cool to room temperature. During the cooling process, continue to stir the reaction mixture rapidly. After allowing the reaction mixture to stand at room temperature for about 1 hour or so, filter-off the precipitated product, wash with several hundred milliliters of ice-cold water, and vacuum dry or air-dry the product. The result will be LNTA in the form of granular yellowish white crystals.

Notes:

17-05. TADA. *5,5'-bi-1H-tetrazole diammonium salt*

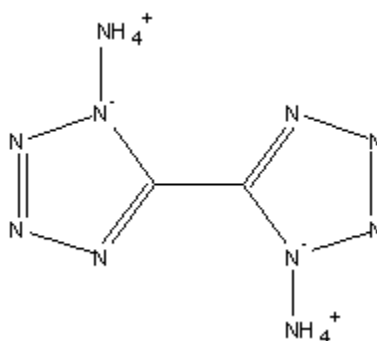

TADA

TADA is an interesting high explosive with excellent properties and resistance to shock, friction, and percussion. It is one of only a few compounds that demonstrate excellent explosives properties without actually having any nitro groups. Even though TADA has excellent explosives properties, it is primarily used solely in the manufacturer of rocket propellants when admixed with ammonium perchlorate, HMX, or nitrocellulose and a reducing agent. However, TADA can be used in the preparation of explosive charges when mixed with nitroglycerine, or other liquid explosives. Because of cheaper methods of preparation (as in the following procedure), its popularity is increasing. TADA can also be used in pyrotechnic compositions for use in flares, fireworks, and incendiaries.

Molecular weight: 172.156	Flammability: Highly flammable (deflagrates)
Detonating velocity: 6100 (estimated)	Toxicity: Mild
Sensitivity: Moderate	Classification: Primary explosive

Stability: Moderate

Overall value (as primary explosive): Above Moderate

Procedure 17-05A: Preparation of TADA

Materials:	1. 28 grams of 99% hydrogen cyanide
	2. 74 grams of sodium azide
	3. 1040 milligrams of copper-II-sulfate pentahydrate
	4. 54 grams of 35 – 36% hydrogen peroxide
	5. 6 grams of 88% formic acid
	6. 62 grams of ammonium chloride

Summary: TADA is prepared by the reaction between hydrogen cyanide, sodium azide, and formic acid. The reaction mixture is heated several times over a period of several hours. After the heatings, the intermediate produced is reacted with ammonium chloride forming TADA. The TADA is then collected by filtration, washed, and then dried. Commercial & Industrial note: For related, or similar information, see Application No. 374,949, August 16, 1999, by Japan Hydrazine Co., Inc., and Masuda Chemical Industry Co., LTD., Tokyo, JP, to Shunji Hyoda, Sakaide, JP, Masaharu Kita, Sakaide, JP, Hirotohi Sawada, Sakaide, JP, Shuichi Nemugaki, Sakaide, JP, Takahiro Ueta, Sakaide, JP, Kohki Satoh, Sakaide, JP, Sumio Otsuka, Takamatsu, JP, Yoshitaka Miyawaki, Takamatsu, JP, and Hiroshi Taniguchi, Takamatsu, JP. Part or parts of this laboratory process may be protected by international, and/or commercial/industrial processes. Before using this process to legally manufacture the mentioned explosive, with intent to sell, consult any protected commercial or industrial processes related to, similar to, or additional to, the process discussed in this procedure. This process may be used to legally prepare the mentioned explosive for laboratory, educational, or research purposes.

Hazards: Warning! Hydrogen cyanide is a deadly poison. Exposure to hydrogen cyanide can cause death in 5 minutes. Use maximum ventilation, and wear proper safety equipment when handling this substance. Keep a gas mask in hands reach just in case of accident.

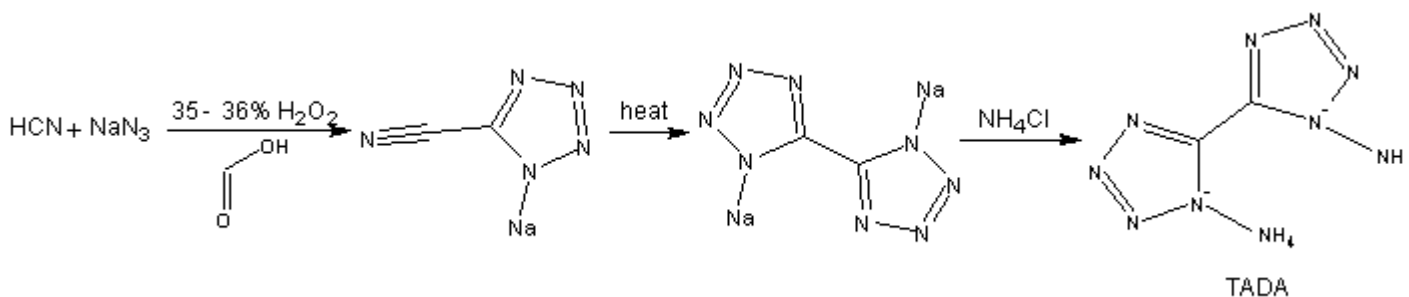

Reaction Equation

Procedure: 1. Prepare a hydrogen cyanide solution by dissolving 28 grams of 99% hydrogen cyanide into 220 grams water, and then cool the solution to 0 Celsius. 2. Prepare a second solution by dissolving 74 grams of sodium azide into 200 grams of water, and then cool this solution to 0 Celsius. Now, slowly add drop wise, the hydrogen cyanide solution to the sodium azide solution over a period of 20 minutes while keeping the temperature of the sodium azide solution at 0 Celsius and stirring. Next, add 1 grams of copper-II-sulfate pentahydrate while stirring the reaction mixture. Afterwards, prepare another solution by mixing 54 grams of 35 – 36% hydrogen peroxide, 4 grams of water, and 6 grams of 88% formic acid, and then cool this solution to 0 Celsius. Then slowly add, drop wise, this solution to the reaction mixture over a period of 90 minutes while keeping the temperature of the reaction mixture at 0 Celsius and stirring. After the addition of the hydrogen peroxide/water/formic acid solution, remove the ice bath and then stir the reaction mixture at room temperature for one hour. After one hour, heat the reaction mixture to 30 Celsius while stirring. Right when the temperature of the reaction mixture hits 30 Celsius, increase the heat to 40 Celsius, and heat at this temperature for 2 hours with stirring. After 2 hours, raise the temperature to 90 Celsius, and then heat the reaction mixture at this temperature for 6 hours with stirring. After 6 hours, add 62 grams of ammonium chloride, and then reduce the heat to 50 Celsius. Then stir the reaction mixture at 50 Celsius for 2 hours. Thereafter, remove the heat source, and then cool the reaction mixture to 10 Celsius by means of an ice water bath while continuously stirring the reaction mixture. Keep at the reaction mixture at 10 Celsius while stirring for 1 hour. After 1 hour, filter-off the precipitated crystal product, and then wash the crystals with 100 milliliters of cold water. Then vacuum dry or air-dry the product.

Notes:

CHAPTER 18: THE PREPARATION OF NITRO PHENYLS

TPG, DNP, DNR, PICRIC ACID, STYPHNIC ACID, PICRAMIC ACID, METHYLPICRIC ACID, TA

18-01. TPG. 2,4,6-trinitrophenol

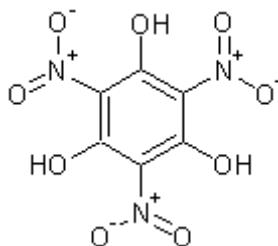

TPG

TPG forms colorless, long, spear like needles with a melting point of 165 Celsius. It can be used as a substitute for picric acid, but readily forms shock sensitive salts with metal hydroxides or carbonates. TPG can be used with satisfactory results when alloyed with RDX, HMX, or PETN for use in blasting compositions. TPG readily forms a triammonium salt when treated with aqueous ammonia. This ammonium salt is used in rocket propellants, fireworks, and pyrotechnic compositions—as it self deflagrates.

Molecular weight: 261.103	Flammability: Burns with smoky flame
Detonating velocity: Similar to picric acid	Toxicity: Moderate
Sensitivity: Low	Classification: Secondary explosive
Stability: Good	Overall value (as secondary explosive): Moderate

Procedure 18-01A: Preparation of TPG

Materials:	1. 76 milliliters of 70% nitric acid
	2. 1124 milliliters of 98% sulfuric acid
	3. 50 grams phloroglucinol
	4. 500 milliliters 5% hydrochloric acid

Summary: TPG can be prepared by reacting phloroglucinol with a nitrating acid in the presence of excess sulfuric acid. The reaction mixture is then treated with ice, and the precipitated product recovered by filtration. The dried product can be recrystallized from dichloroethane to obtain high purity TPG if desired, but is not necessary for the production of TPG containing explosive compositions. Commercial & Industrial note: For related, or similar information, see Application No. 434,460, February 28th 1984, by The United States Navy, to DeFusco, Jr., Albert A. Nielsen, Arnold T. Atkins, and Ronald L. all of Ridgecrest, CA. Part or parts of this laboratory process may be protected by international, and/or commercial/industrial processes. Before using this process to legally manufacture the mentioned explosive, with intent to sell, consult any protected commercial or industrial processes related to, similar to, or additional to, the process discussed in this procedure. This process may be used to legally prepare the mentioned explosive for laboratory, educational, or research purposes.

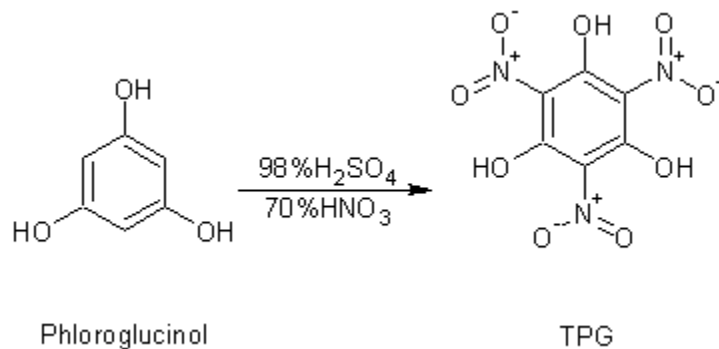
*Reaction Equation*

Hazards: Wear gloves when handling 98% sulfuric acid, and 70% nitric acid; both can cause skin burns and irritation. 98% sulfuric acid is a strong dehydrating agent capable of charring many organic substances, including cloths.

Procedure: Prepare a nitrating acid mixture by adding 124 milliliters of 98% sulfuric acid into 76 milliliters of 70% nitric acid. Then prepare a phloroglucinol solution by adding and dissolving 50 grams of phloroglucinol into 1000 milliliters of 98% sulfuric acid. Afterwards, place this phloroglucinol mixture into an ice bath and cool to about 0 Celsius. When the mixture is about 0 Celsius, slowly add, drop wise, the nitrating acid mixture over a period of about 2 hours while maintaining the reaction temperature at about 0 to 5 Celsius with constant stirring. After the addition of the nitrating acid, continue to stir the reaction mixture for about 20 minutes (some precipitate will form). Then add the entire reaction mixture, including the precipitate to 3600 grams of ice contained in a beaker. After the ice melts, filter-off the precipitated product, wash with four 125 milliliter portions of 5% hydrochloric acid solution, and then vacuum dry or air-dry the product. The result will be relatively pure TPG suitable for manufacturing explosive compositions. This product can be recrystallized from 1600 milliliters of dichloroethane to obtain high purity TPG.

Note: Keep this substance away from heavy metals and their salts to prevent the formation of shock sensitive salts which easily detonate by heat, sparks, friction, or percussion.

Notes:

18-02. DNP. 2,4-Dinitrophenol

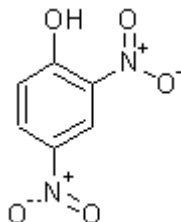

2,4-Dinitrophenol

2,4-Dinitrophenol forms stable, yellowish to yellow orthorhombic crystals with a melting point of 114 Celsius. It sublimes when carefully heated, and is volatile with steam. It is insoluble in water and chloroform, slightly soluble in ethyl acetate, and soluble in acetone, alcohol, and benzene. It is moderately soluble in pyridine. 2,4-Dinitrophenol is toxic, and ingestion or skin absorption causes weight loss, and then accumulative disorders leading to death. It readily forms shock sensitive and explosive salts with many metal hydroxides and carbonates. 2,4-Dinitrophenol is a powerful explosive, which was largely used during WWI, but its use has been significantly decreased. DNP can be used in explosive charges when alloyed with TNT, RDX, or other secondary explosives (ratio of 1 to 1). The ammonium salt of DNP is used in fireworks, and pyrotechnic compositions, and is made by treating DNP with aqueous ammonia.

Molecular weight: 184.106

Flammability: Burns with smoky flame

Detonating velocity: Similar to picric acid	Toxicity: Moderate
Sensitivity: Low	Classification: Secondary explosive
Stability: Good	Overall value (as secondary explosive): Moderate

Procedure 18-02A: Preparation of DNP

Materials:	1. 94 grams phenol
	2. 86 grams sodium nitrite
	3. 42 grams sodium hydroxide
	4. 800 milliliters of 26% nitric acid
	5. 400 milliliters 60% Nitric acid

Summary: 2,4-Dinitrophenol is prepared by reacting phenol with sodium hydroxide, sodium nitrite, and dilute nitric acid. A nitroso intermediate is formed, which is then converted to 2,4-dinitrophenol by treatment with 60% nitric acid. The 2,4-Dinitrophenol is then recovered by filtration. After which, the DNP is washed and dried. Commercial & Industrial note: For related, or similar information, see Application No. 365,208, May 30, 1973, by David Anthony Salter, 35, Roseacres, Takely, Essex, England, Robert John James Simkins, 3, Upper Park, Harlow, Essex, England. Part or parts of this laboratory process may be protected by international, and/or commercial/industrial processes. Before using this process to legally manufacture the mentioned explosive, with intent to sell, consult any protected commercial or industrial processes related to, similar to, or additional to, the process discussed in this procedure. This process may be used to legally prepare the mentioned explosive for laboratory, educational, or research purposes.

Hazards: Wear gloves when handling phenol. Phenol is highly toxic and can be absorbed through the skin. Perform the chemical reaction with proper ventilation as poisonous fumes of nitrogen oxides are produced.

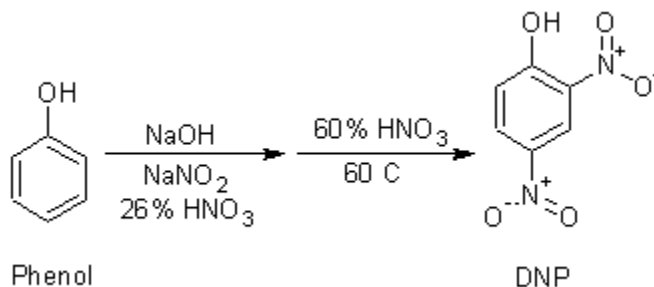

Reaction Equation

Procedure: Prepare a solution by dissolving 42 grams sodium hydroxide and 86 grams sodium nitrite into 1000 milliliters water. Afterwards, dissolve 94 grams of phenol and stir the mixture vigorously. While dissolving the phenol, keep the temperature of the mixture at room temperature (use a cold water bath is necessary. After the addition of the phenol, add 1000 grams crushed ice. After adding the ice, slowly add 800 milliliters of a 26% nitric acid solution over a period of 40 minutes while stirring and maintaining the temperature of the reaction mixture at room temperature. After the addition of the 26% nitric acid, lower the temperature of the reaction mixture to 5 Celsius by means of an ice bath. Then hold this temperature at 5 Celsius for 1 hour. After which, place 400 milliliters of 60% nitric acid into a flask and then heat to 60 Celsius. When the 60% nitric acid reaches 60 Celsius, slowly add the reaction mixture over a period of 30 minutes while stirring, and keeping the temperature of the 60% nitric acid mixture at 60 Celsius. During the first part of the addition, there will be a moderate evolution of nitrogen oxide fumes. After complete addition, raise the temperature of the reaction mixture to 90 Celsius, and keep this temperature for 3 hours. After 3 hours, remove the heat source and allow the reaction mixture to cool to room temperature. Then filter-off the precipitated 2,4-dinitrophenol, wash with 1000 milliliters of water, and then vacuum dry or air dry. The 2,4-dinitrophenol product will have a melting point of 114 Celsius.

Note: Keep this substance away from heavy metals and their salts to prevent potential formation of shock sensitive materials, which easily detonate by heat, shock, sparks, or friction.

Notes:

“Phenolene” DNP explosive composition

Place 11 kilograms of DNP into 1680 milliliters of cold water, and then manually blend the mixture rapidly for 1 hour to form a slurry. Afterwards, add 1500 milliliters of more cold water, and continue rapid blending for 1 hour. Then add 9 grams of a 0.11% Teepol L solution (commercially available), and then manually blend for 20 minutes. After 20 minutes, slowly add 500 grams of Wax 3 (p-phenylene diamine and stearic acid; commercially available) over a period of 10 minutes while continuously blending the slurry. After the addition of the wax 3, manually blend the mixture thoroughly for 60 minutes at room temperature. Afterwards, filter-off the explosive product, and then place the explosive product on a tray and allow to dry for 3 days. After the explosive has dried, press the explosive into any desirable mold, container, bomb casing, or warhead casing under high pressure. For demolition use, remove the pressed explosive from the container and then wrap in paper, plastic, or cardboard. It requires a blasting cap or detonator for initiation. Commercial & Industrial note: Part or parts of this laboratory process may be protected by international, and/or commercial/industrial processes. Before using this process to legally manufacture the mentioned explosive, with intent to sell, consult any protected commercial or industrial processes related to, similar to, or additional to, the process discussed in this procedure. This process may be used to legally prepare the mentioned explosive for laboratory, educational, or research purposes.

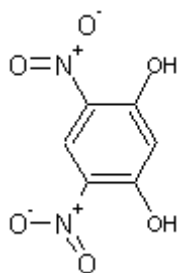
18-03. DNR. 4,6-dinitroresorcinol

DNR

Uses: Substitute for DNP, and Picric acid in explosives compositions. Readily forms primary explosives when treated with metal hydroxides, or carbonates. The ammonium salt is prepared by treating DNR with aqueous ammonia, and is used in fireworks, and pyrotechnic compositions—as it self deflagrates.

Molecular weight: 200.106	Flammability: Burns with smoky flame
Detonating velocity: Similar to picric acid	Toxicity: Moderate
Sensitivity: Low	Classification: Secondary explosive
Stability: Good	Overall value (as secondary explosive): Moderate

Procedure 18-03A: Preparation of DNR

Materials:	1. 2000 milliliters of 70% nitric acid
	2. 1740 milliliters of 90% nitric acid
	3. 120 milliliters 98% sulfuric acid
	4. 400 grams resorcinol diacetate
	5. 160 grams urea

Summary: 4,6-Dinitroresorcinol is prepared by the action of 70% nitric acid on resorcinol diacetate. Some urea is added in order to control the nitration and ensure no by-product nitrosation takes place. After the addition of the 70% nitric acid, the intermediate produced is treated with 90% nitric acid yielding the 4,6-dinitroresorcinol as a golden yellow solid. Commercial & Industrial note: For related, or similar information, see Application No. 001,243, January 7, 1987, by SRI International, to Robert J. Schmitt, (Mountain View, CA, David S. Ross, Palo Alto, CA, James F. Wolfe, Palo Alto, CA. Part or parts of this laboratory process may be protected by international, and/or commercial/industrial processes. Before using this process to legally manufacture the mentioned explosive, with intent to sell, consult any protected commercial or industrial processes related to, similar to, or additional to, the process discussed in this procedure. This process may be used to legally prepare the mentioned explosive for laboratory, educational, or research purposes.

Hazards: Wear gloves and use proper ventilation when handling 70% nitric acid, and 90% nitric acid. 90% nitric acid is highly toxic and corrosive yielding highly toxic fumes of nitrogen oxides.

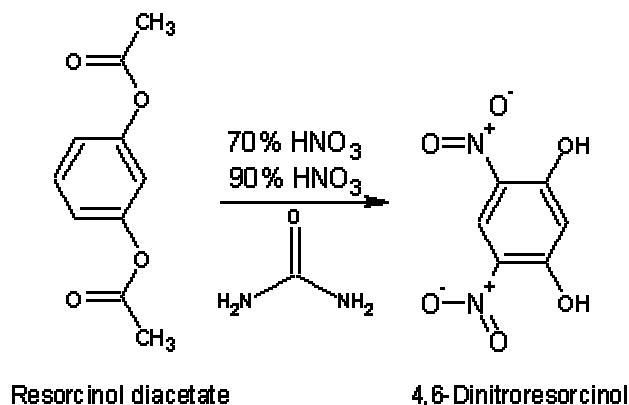

Reaction Equation

Procedure: Note: This procedure uses an excessive amount of 90% and 70% nitric acid to properly carry out the reaction. This excessive amount of acid can be recovered by treating the reaction mixture (after complete removal of the product) with methylene chloride to recover the nitric acid. Prior to this action, a small amount of sulfuric acid should be added to the reaction mixture. Afterwards, the reaction mixture should be extracted with several volumes of methylene chloride. These combined volumes can then be carefully distilled to recover the nitric acid of 99% purity (see nitric acid, 70%, 90% and 99% respectively).

Place 2000 milliliters of 70% nitric acid into a flask. Then add 160 grams of urea. After adding the urea, cool the mixture to 0 Celsius by means of an ice bath. Now, slowly add 388 grams of resorcinol diacetate over a period of about 1 hour while rapidly stirring the 70% nitric acid/urea mixture. After addition of the resorcinol diacetate, stir the reaction mixture for one hour. After which, slowly add 1740 milliliters of 90% fuming nitric acid while continuing to stir the reaction mixture. During the course of the 90% nitric acid addition, a yellowish-gold precipitate can be observed forming. After the addition of the 90% nitric acid, filter-off the precipitated product, and then pour the filtered liquid onto 1000 grams of ice contained in a beaker. After the ice has melted, re-filter the liquid (using the same filter) to obtain more precipitated product. Afterwards, wash all the collected precipitate with 2000 milliliters of cold water, and then vacuum dry or air-dry.

Note: Keep this substance away from all metals and their salts to prevent potential formation of shock sensitive materials, which easily detonate by heat, shock, sparks, or friction.

Notes:

18-04. Picric Acid. 2,4,6-trinitrophenol

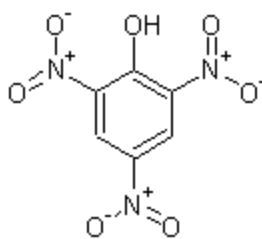

Picric acid

Picric acid is a pale yellow, odorless solid with a melting point of 123 Celsius. It explodes when heated to 300 Celsius. It is relatively insoluble in water, but soluble in alcohol, and benzene. Picric acid is toxic and can be absorbed through the skin with

CHAPTER 18: THE PREPARATION OF NITRO PHENYLS

effects similar to DNP. Picric acid should be stored wet with 10% water, and kept in a cool place and away from fire. Picric acid will detonate if rapidly heated, or on percussion—the percussion is much higher than for most primary explosives. Picric acid was largely used during WWI, but its use has decreased. However, picric acid still demonstrates outstanding properties for use in explosives charges. It can be alloyed with TNT, RDX, HMX, and many other secondary explosives for use in blasting compositions, warheads, grenades, and land mines. Picric acid is also used in high performance gun propellants with ammonium picrate, nitrocellulose, and sodium or potassium nitrate. Picric acid readily forms primary explosives when treated with metal hydroxides, or carbonates.

Molecular weight: 229.104	Flammability: Burns with smoky flame but may flash on strong ignition
Detonating velocity: 7400	Toxicity: Above moderate
Sensitivity: Low	Classification: Secondary explosive
Stability: Good	Overall value (as secondary explosive): High

Procedure 18-04A: Preparation of Picric acid

Materials:	1. 94 grams phenol
	2. 42 grams sodium hydroxide
	3. 86 grams sodium nitrite
	4. 800 milliliters 26% nitric acid
	5. 250 milliliters of 90% fuming nitric acid

Summary: Picric acid is prepared from phenol by nitration of the nitrosophenol intermediate. The nitrosophenol intermediate is prepared by treating phenol with sodium hydroxide and sodium nitrite. The resulting nitrosophenol intermediate is then nitrated with fuming nitric acid. Commercial & Industrial note: For related, or similar information, see Application No. 365,208, May 30, 1973, by David Anthony Salter, 35, Roseacres, Takely, Essex, England, Robert John James Simkins, 3, Upper Park, Harlow, Essex, England. Part or parts of this laboratory process may be protected by international, and/or commercial/industrial processes. Before using this process to legally manufacture the mentioned explosive, with intent to sell, consult any protected commercial or industrial processes related to, similar to, or additional to, the process discussed in this procedure. This process may be used to legally prepare the mentioned explosive for laboratory, educational, or research purposes.

Hazards: Use gloves when handling phenol. Phenol is very toxic and is rapidly absorbed by the skin. Both phenol and sodium hydroxide are very corrosive. Wear gloves and use proper ventilation when handling 90% nitric acid. The acid is very toxic and emits poisonous fumes of nitrogen oxides.

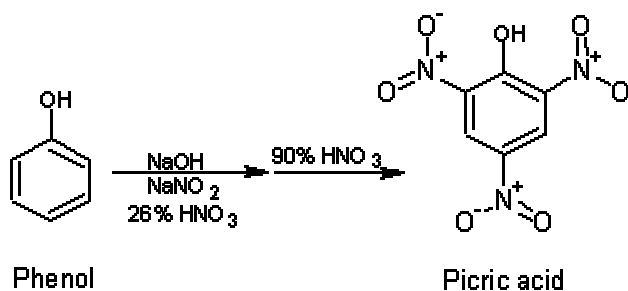

Reaction equation

Procedure: Note: This procedure uses an excessive amount of 26% and 90% nitric acid to properly carry out the reaction. This excessive amount of acid can be recovered by treating the reaction mixture (after complete removal of the product) with methylene chloride to recover the nitric acid. Prior to this action, a small amount of sulfuric acid should be added to the reaction mixture. Afterwards, the reaction mixture should be extracted with several volumes of methylene chloride. These combined volumes can then be carefully distilled to recover the nitric acid of 99% purity (see nitric acid, 90% and 99% respectively).

Prepare a solution by dissolving 42 grams of sodium hydroxide, and 86 grams sodium nitrite into 1000 milliliters of water. Afterwards, place this solution into a cold-water bath, and then add 94 grams of phenol while stirring the solution and maintaining its temperature below 20 Celsius by means of the water bath. After the addition of the phenol, place the reaction mixture into an ice/salt bath to lower its temperature to -5 Celsius. After which, slowly add 800 milliliters of 26% nitric acid while stirring the reaction mixture and maintaining its temperature at -5 Celsius. After the addition of the 26% nitric acid, keep the temperature of the reaction mixture at -5 Celsius for 1 hour, and continue stirring to form a slurry. After 1 hour, add 250

CHAPTER 18: THE PREPARATION OF NITRO PHENYLS

milliliters of 90% nitric acid to a 3-liter flask, and then heat to 50 Celsius. When the 90% nitric acid reaches 50 Celsius, slowly transfer the reaction mixture slurry into the hot 90% nitric acid while stirring the 90% nitric acid and maintaining its temperature at 50 Celsius (during the addition, if the 90% nitric acid's temperature rises above 50 Celsius, temporarily remove the heat source). After the addition of the reaction mixture slurry into the hot 90% nitric acid, raise the temperature of the reaction mixture to 96 Celsius, and keep it at this temperature while stirring for 3 hours. After 3 hours, remove the heat source and allow the reaction mixture to cool to room temperature. Afterwards, mix the entire reaction mixture with 1500 milliliters of cold water, and then filter-off the picric acid precipitate. Then wash the picric acid with 500 milliliters of cold water, and then vacuum dry, or air-dry.

Note: Keep this substance away from heavy metals and their salts to prevent potential formation of shock sensitive materials, which easily detonate by heat, shock, sparks, or friction.

Notes:

Procedure 18-04B: Preparation of Picric acid

Materials:	1. 50 grams of aspirin
	2. 350 milliliters of 95% ethyl alcohol
	3. 350 grams of 98% sulfuric acid
	4. 115 grams of potassium nitrate or 95 grams of sodium nitrate

Summary: In this procedure, picric acid is prepared by the reaction of common aspirin (acetylsalicylic acid) with potassium or sodium nitrate in the presence of excess concentrated sulfuric acid. After the reaction, the entire mixture is then drowned into an excessive amount of ice water, whereby the picric acid precipitates, and is then collected by filtration, washed, and then dried.

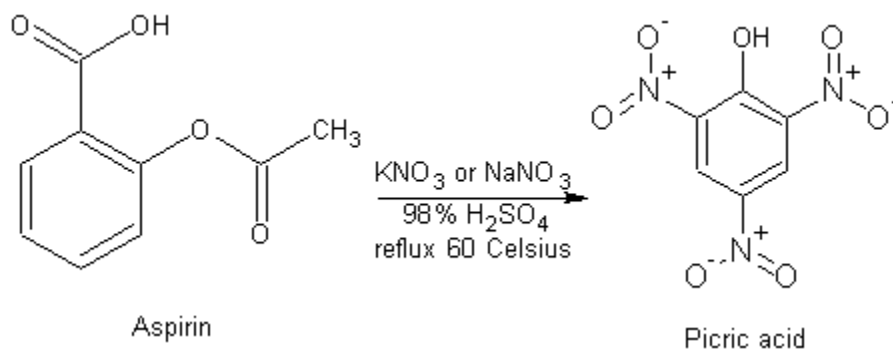

Reaction Equation

Hazards: Use caution when handling 98% sulfuric acid, which is highly corrosive and chars many substances. Extinguish all flames before using 95% ethyl alcohol, which is flammable.

Procedure: Place 50 grams of aspirin into a beaker, and then add 350 milliliters of 95% ethyl alcohol (note: about 50 grams of aspirin can be obtained by crushing up 100, 500-milligram tablets of store bought aspirin tablets—these crushed up tablets can be added directly to the 350 milliliters of 95% ethyl alcohol). Thereafter, stir the mixture to fully dissolve the aspirin, and then filter-off any insoluble impurities—such as starch, and other fillers (if using medical aspirin tablets), and then recrystallize the aspirin from this 95% ethyl alcohol solution. Thereafter, vacuum dry or air-dry the collected aspirin crystals. Now, into a clean flask equipped with thermometer, motorized stirrer and powder funnel, place 350 grams of 98% sulfuric acid, and then place this flask into an ice bath, and chill to 0 Celsius. Thereafter, slowly add in small portions, 115 grams of potassium nitrate, or 95 grams of sodium nitrate to the sulfuric acid over a period of about 1 hour, while rapidly stirring the sulfuric acid, and maintaining its temperature below 5 Celsius. After the addition of the sodium or potassium nitrate, slowly add the dry recrystallized aspirin, in small portions, over a period of about 1 hour while rapidly stirring the sulfuric acid/nitrate mixture, and keeping it temperate below 5 Celsius. After the addition of the aspirin, replace the powder funnel with a condenser, and reflux the mixture for 2 hours at 60 Celsius with rapid stirring. After 2 hours, remove the heat source, and allow the reaction

CHAPTER 18: THE PREPARATION OF NITRO PHENYLS

mixture to cool to room temperature. Then gradually add the reaction mixture to 1500 milliliters of ice water, and then allow the entire mixture to stand for 3 hours. Thereafter, filter-off the precipitated picric acid, wash excessively with 10, 250-milliliter portions of ice cold water. Note: washing with base to remove traces of acid should be avoided as formation of the corresponding picrate salts may develop. After the washing process, vacuum dry or air-dry the solid product.

Notes:

“Pentotal” Picric acid explosive composition

Place 11 kilograms of picric acid into 1680 milliliters of cold water and then manually blend the mixture rapidly for 1 hour to form a slurry. Afterwards, add 1500 milliliters of more cold water and continue rapid blending for 1 hour. Then add 9 grams of a 0.11% Teepol L solution, and then manually blend for 20 minutes. After 20 minutes, slowly add 500 grams of Wax 3 (p-phenylene diamine and stearic acid) over a period of 10 minutes while continuously blending the slurry. After the addition of the wax 3, manually blend the mixture thoroughly for 1 hour at room temperature. Afterwards, filter-off the explosive product, and then place the explosive product on a tray and allow to dry for 3 days. After the explosive has dried, press the explosive into any desirable mold, container, bomb casing, or warhead casing under mild pressure. For demolition use, remove the pressed explosive from the mold or container and then wrap in paper, plastic, or cardboard. The mold or container should be 1 – 2 inches wide by 5 – 11 inches long. It requires a blasting cap or detonator for initiation. Commercial & Industrial note: Part or parts of this laboratory process may be protected by international, and/or commercial/industrial processes. Before using this process to legally manufacture the mentioned explosive, with intent to sell, consult any protected commercial or industrial processes related to, similar to, or additional to, the process discussed in this procedure. This process may be used to legally prepare the mentioned explosive for laboratory, educational, or research purposes.

18-05. Styphnic Acid. 2,4,6-trinitro-1,3-benzenediol

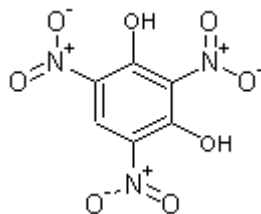

Styphnic acid

Styphnic acid is a yellow crystalline solid with a melting point of 176 Celsius. It is insoluble in water, but soluble in alcohol, ether, and acetic acid. Styphnic acid turns deep yellow on contact with air, so it should be stored in tightly sealed bottles in a cool place. The compound is corrosive and readily forms salts with metal hydroxides and carbonates—many of which are primary explosives, i.e., lead styphnate. Styphnic acid burns rapidly and violently when ignited. For safety reasons, styphnic acid should be stored wet with 10% water. It is used primarily in the manufacture of lead styphnate, but is used with outstanding results in explosives compositions when mixed with nitrocellulose, sodium nitrate, or ammonium perchlorate and adding inert fillers such as sodium sulfate, wax, paraffins, glue, oils, or gum Arabic. It is also widely used in initiating compositions along with lead styphnate, or in combination with lead azide or diazodinitrophenol. Styphnic acid also demonstrates potential use in fireworks and other pyrotechnic compositions.

Molecular weight: 245.103	Flammability: Flammable—self deflagrates and may detonate when ignited
Detonating velocity: 7200 (estimated) also reported as 7300	Toxicity: Above Moderate
Sensitivity: Moderate	Classification: Secondary explosive
Stability: Moderate	Overall value (as secondary explosive): High

Procedure 18-05A: Preparation of Styphnic acid

CHAPTER 18: THE PREPARATION OF NITRO PHENYLS

Materials:	1. 220 grams resorcinol
	2. 840 milliliters of 16% nitric acid
	3. 300 grams sodium nitrite
	4. 800 milliliters 60% nitric acid

Summary: Styphnic acid is prepared from a dinitroso intermediate formed by the reaction between resorcinol, dilute nitric acid, and sodium nitrite. The dinitroso intermediate is converted into styphnic acid by treatment with 60% nitric acid.

Commercial & Industrial note: For related, or similar information, see Application No. 365,208, May 30, 1973, by David Anthony Salter, 35, Roseacres, Takely, Essex, England, Robert John James Simkins, 3, Upper Park, Harlow, Essex, England. Part or parts of this laboratory process may be protected by international, and/or commercial/industrial processes. Before using this process to legally manufacture the mentioned explosive, with intent to sell, consult any protected commercial or industrial processes related to, similar to, or additional to, the process discussed in this procedure. This process may be used to legally prepare the mentioned explosive for laboratory, educational, or research purposes.

Hazards: Wear gloves when handling 60% nitric acid.

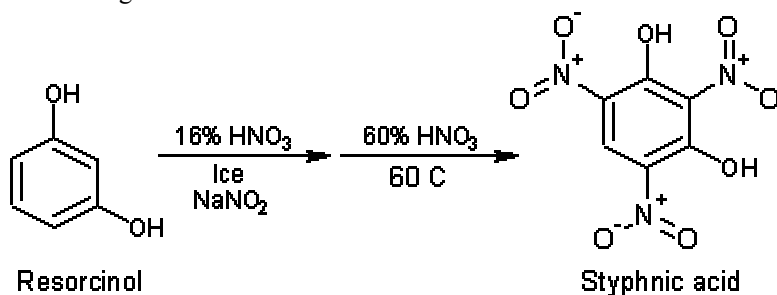

Reaction Equation

Procedure: Place 220 grams of resorcinol, 840 milliliters of 16% nitric acid, and 1900 grams of crushed ice into a suitable flask fitted with a stirrer. When the resorcinol has been dissolved, prepare a new solution by dissolving 300 grams of sodium nitrite into 1830 milliliters of water, and then add this sodium nitrite solution to the resorcinol/nitric acid solution slowly, over a period of 60 minutes with vigorous stirring. After the addition, place 800 milliliters of 60% nitric acid into a suitable flask and heat to 60 Celsius. After which, slowly transfer (portion wise) the resorcinol/nitric acid mixture into the hot 60% nitric acid over a period of 4 hours while maintaining the temperature of the 60% nitric acid at 60 Celsius and stirring. After the addition, raise the temperature of the mixture to 82 Celsius, and then heat at 82 Celsius for 30 minutes. After which, slowly raise the temperature to 97 Celsius while stirring, and heat for 90 minutes at 97 Celsius. Afterwards, remove the heat source and allow the mixture to cool to room temperature. After which, filter-off the precipitated styphnic acid, wash with 2000 milliliters of cold water, and then vacuum dry or air-dry the product.

Note: Keep this substance away from heavy metals and their salts to prevent potential formation of shock sensitive materials which easily detonate by heat, shock, sparks, or friction.

Notes:

Procedure 18-05B: Preparation of Styphnic acid

Materials:	1. 440 grams resorcinol
	2. 452 grams 98% sulfuric acid
	3. 600 grams sodium nitrite
	4. 3000 milliliters 40% nitric acid
	5. 300 milliliters of 2% nitric acid

Summary: Styphnic acid can be prepared by nitrating resorcinol in a two-step process. The first step is the preparation of dinitroresorcinol, which is prepared by the reaction of resorcinol with sodium nitrite and sulfuric acid. The dinitroresorcinol is converted into styphnic acid by treatment with dilute nitric acid. The product is then precipitated, washed, and then dried. The

CHAPTER 18: THE PREPARATION OF NITRO PHENYLS

lead styphnate produced in this procedure is suitable for lead styphnate production. Commercial & Industrial note: For related, or similar information, see Serial No. 296,250, November 10th, 1942, by Western Cartridge Company, to Delbert R. Jones, East Alton ILL., and Carl L. Roberts, Wood River, ILL. Part or parts of this laboratory process may be protected by international, and/or commercial/industrial processes. Before using this process to legally manufacture the mentioned explosive, with intent to sell, consult any protected commercial or industrial processes related to, similar to, or additional to, the process discussed in this procedure. This process may be used to legally prepare the mentioned explosive for laboratory, educational, or research purposes.

Hazards: 98% Sulfuric acid is a strong dehydrating agent. Wear proper clothing when handling, and wear gloves.

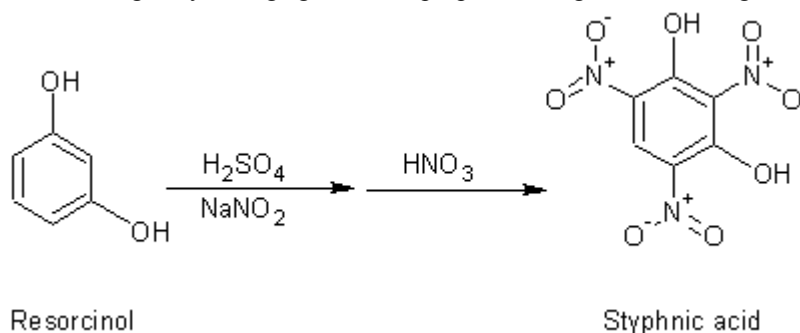

Reaction equation

Procedure:

Step 1: Preparation of Dinitroresorcinol monohydrate

To 16 liters of water add and dissolve 440 grams of resorcinol, and then 452 grams of 98% sulfuric acid. Immediately thereafter, add 6800 grams of crushed ice to mixture, and then stir the mixture vigorously until the internal temperature of the mixture reaches about 0 Celsius. Then prepare a solution by dissolving 600 grams of sodium nitrite into 3200 milliliters of water, and then add this sodium nitrite solution to the sulfuric/resorcinol mixture over a period of 6 minutes while vigorously stirring the mixture and maintaining its temperature below 5 Celsius. After the addition of the sodium nitrite solution, continue to stir and cool the reaction mixture below 5 Celsius for 30 minutes. Note: A precipitate will begin to form. After the 30 minute period, filter-off the precipitated dinitroresorcinol monohydrate, and wash with several hundred milliliters of cold water (use gravity filtration).

Step 2: Preparation of Styphnic acid

Place 3000 milliliters of 40% nitric acid into a beaker, and then gently heat this mixture to about 30 Celsius. Thereafter, carefully mix the moist filter cake, prepared at the end of step 1 to the nitric acid solution over a period of about 30 minutes, while stirring the nitric acid and keeping its temperature around 30 Celsius. Immediately after the first addition of the filter cake, nitrogen oxide gases will be evolved, followed by the formation of a foam (the foam will dissipate after about 10 minutes). After the addition, raise the temperature of the mixture to 95 Celsius, and then hold this temperature for 1 hour. After heating for 1 hour, remove the heat source and allow the reaction mixture to cool to room temperature. Note: A precipitate will form. When the reaction mixture reaches room temperature, filter-off the precipitated product, wash with 300 milliliters of 2% nitric acid, and then with 600 milliliters of cold water. Then vacuum dry or air-dry the product. The result will be pale yellow crystals, well suitable for use in preparing lead styphnate, or styphnic acid compositions.

Note: Keep this substance away from heavy metals and their salts to prevent potential formation of shock sensitive materials which easily detonate by heat, shock, sparks, or friction.

Notes:

18-06. Picramic acid. 2-amino-4,6-dinitrophenol

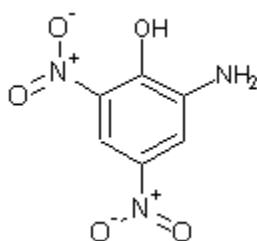

Picramic acid

Picramic acid forms dark red needles, with a melting point of 170 Celsius. It is insoluble in water, but soluble in glacial acetic acid and benzene. A small sample of picramic acid explodes in contact with a flame producing a brilliant flash, and larger samples ignite rapidly and burn violently. Its chief uses are in the manufacture of picramates for use in primary explosive compositions for blasting caps and detonators and pyrotechnic compositions, and in the preparation of compositions for flares, incendiary compositions, fireworks, and many other pyrotechnic compositions. It also has significant use in rocket propellants, and high performance gunpowders. Picramic acid can be used in explosives charges when mixed with nitrocellulose, TNT, or other secondary explosives for use in demolition charges.

Molecular weight: 199.121	Flammability: Highly Flammable—flashes on ignition
Detonating velocity: Similar to picric acid	Toxicity: Moderate
Sensitivity: Moderate	Classification: Secondary explosive
Stability: Good	Overall value (as secondary explosive): High

Procedure 18-06A: Preparation of Picramic acid

Materials:	1. 26.8 grams glacial acetic acid
	2. 100 grams ammonium picramate

Summary: Picramic acid is prepared by treating ammonium picramate with glacial acetic acid. The picramic acid is then collected by filtration, washed, and then dried in an oven. Commercial & Industrial note: Part or parts of this laboratory process may be protected by international, and/or commercial/industrial processes. Before using this process to legally manufacture the mentioned explosive, with intent to sell, consult any protected commercial or industrial processes related to, similar to, or additional to, the process discussed in this procedure. This process may be used to legally prepare the mentioned explosive for laboratory, educational, or research purposes.

Hazards: Wear gloves when handling glacial acetic acid. Glacial acetic acid can cause skin burns.

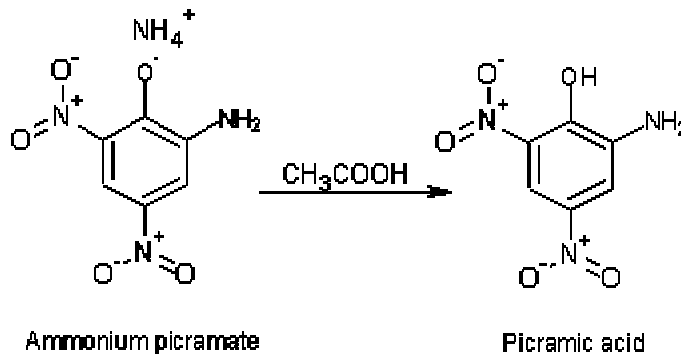

Reaction Equation

Procedure: Dissolve 100 grams of ammonium picramate in 1000 milliliters of cold water while stirring the water (if some of the ammonium picramate fails to dissolve, add an additional 400 milliliters of water). To this solution, add drop wise, over a period of ten minutes, 26.8 grams of glacial acetic acid. After the addition of the glacial acetic acid, filter-off the product, wash with 400 milliliters of cold water, and then dry in an oven at 80 Celsius for 1 hour.

Note: Salts of picramic acid are made by neutralizing picramic acid with metal hydroxides or carbonates. Most salts of picramic acid are primary explosives.

Notes:

18-07. Methylpicric acid. *2,4,6-trinitro-3-methylphenol*

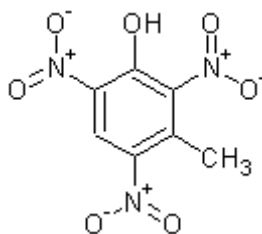

Methylpicric acid

Uses: Primarily as a substitute for picric acid, DNP, and DNR in explosives compositions for demolition charges. The ammonium salt of methylpicric acid is a primary explosive used in priming compositions, initiation compositions, fireworks, and many pyrotechnic compositions.

Molecular weight: 243.131	Flammability: Burns with smoky flame
Detonating velocity: Similar to picric acid	Toxicity: Moderate
Sensitivity: Low	Classification: Secondary explosive
Stability: Good	Overall value (as secondary explosive): Moderate

Procedure 18-07A: Preparation of Methylpicric acid

Materials:	1. 64.8 grams m-cresol
	2. 45 grams sodium nitrite
	3. 24 grams sodium hydroxide
	4. 60 milliliters 90% fuming nitric acid
	5. 300 milliliters 60% Nitric acid

Summary: Methylpicric acid is prepared from a nitroso intermediate, which is prepared by reacting m-cresol with sodium nitrite and sodium hydroxide. Afterwards, the nitroso intermediate is then nitrated with nitric acid forming methylpicric acid. The methylpicric acid is then collected by filtration, washed, and dried. Commercial & Industrial note: For related, or similar information, see Application No. 365,208, May 30, 1973, by David Anthony Salter, 35, Roseacres, Takely, Essex, England, Robert John James Simkins, 3, Upper Park, Harlow, Essex, England. Part or parts of this laboratory process may be protected by international, and/or commercial/industrial processes. Before using this process to legally manufacture the mentioned explosive, with intent to sell, consult any protected commercial or industrial processes related to, similar to, or additional to, the process discussed in this procedure. This process may be used to legally prepare the mentioned explosive for laboratory, educational, or research purposes.

Hazards: Warning! Wear gloves when handling 90% nitric acid, and use proper ventilation. 90% nitric acid is a highly toxic, corrosive liquid, which evolves poisonous fumes of nitrogen oxides. Use great care.

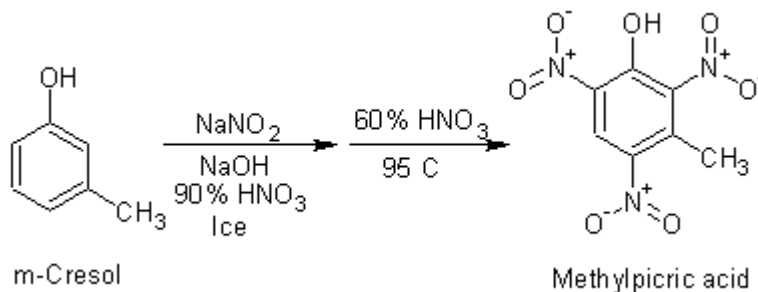
*Reaction equation*

Procedure: Prepare a solution by dissolving 45 grams of sodium nitrite and 24 grams of sodium hydroxide into 120 milliliters of water. Then add and dissolve 64.8 grams of m-Cresol while stirring the sodium nitrite/sodium hydroxide solution at room temperature. After the m-cresol has completely dissolved, place 300 grams of crushed ice into a separate flask, and then add 60 milliliters of 90% nitric acid. Then place this flask into an ice bath, and cool to 0 Celsius. Then, to this 90% nitric acid mixture, slowly add the sodium nitrite/sodium hydroxide/m-cresol solution drop wise, while keeping the temperature of the 90% nitric acid mixture at 0 Celsius and stirring. After the drop-wise addition, remove the ice bath, and allow the reaction mixture to warm to room temperature. Then place the flask into a cold-water bath for 90 minutes to form a slurry. After 90 minutes, place 300 milliliters of 60% nitric acid into a clean flask, and heat to 95 Celsius. When the 60% nitric acid is at 95 Celsius, slowly transfer the reaction mixture slurry, portion wise, into the hot 60% nitric acid while rapidly stirring the 60% nitric acid. After the addition, heat the reaction mixture at 95 Celsius for 3 hours while stirring. After 3 hours, remove the heat source, and allow the reaction mixture to cool to room temperature. After which, add the reaction mixture to 1500 milliliters of cold water, and then stir the whole mixture for 30 minutes. After which, filter-off the methylpicric acid precipitate, wash with 1500 milliliters of coldwater, and then vacuum dry or air dry

Note: Keep this substance away from heavy metals and their salts to prevent potential formation of shock sensitive materials which easily detonate by heat, shock, sparks, or friction.

Notes:

Methylpicric acid explosive composition

Procedure:

Step 1: Preparation of methylpicric acid/wax composition

Mix 11 kilograms of methylpicric acid with 1680 milliliters of water, and then manually blend for 1 hour at room temperature. Then add 1500 milliliters of water, and then manually blend for 30 minutes. Thereafter, add 9 grams of a 0.11% Teepol L solution, and blend for 30 minutes. Then slowly add 500 grams of Wax 3 (p-phenylene diamine and stearic acid) over a period of 30 minutes while rapidly blending the mixture. After all the wax is added, continue stirring at room temperature for 1 hour. Afterwards, place the entire mixture into a shallow pan and allow it dry for several days.

Step 2: Preparation of Aluminum-containing methylpicric acid-wax composition

Place 7 kilograms of the dry product obtained in step 1 into a beaker, and then add 3 kilograms of aluminum powder. Then manually blend the mixture for 1 hour at room temperature. Then press the mixture into any desirable mold, container, bomb casing, or warhead casing under high pressure. For demolitions use, remove the pressed explosive from the mold or container, and then wrap in paper, plastic, or cardboard. For demolition purposes, the mold or container should be 1 to 2 inches wide by 5 to 11 inches long. Requires a blasting cap or detonator for initiation. Commercial & Industrial note: Part or parts of this laboratory process may be protected by international, and/or commercial/industrial processes. Before using this process to legally manufacture the mentioned explosive, with intent to sell, consult any protected commercial or industrial processes related to, similar to, or additional to, the process discussed in this procedure. This process may be used to legally prepare the mentioned explosive for laboratory, educational, or research purposes.

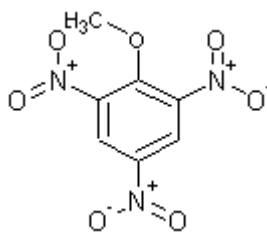
18-08. TA. *Trinitroanisole*

TA

Uses: see methylpicric acid.

Molecular weight: 243.131	Flammability: Burns with smoky flame
Detonating velocity: Similar to picric acid	Toxicity: Moderate
Sensitivity: Low	Classification: Secondary explosive
Stability: Good	Overall value (as secondary explosive): Moderate

Procedure 18-08A: Preparation of TA

Materials:	1. 156 grams picryl chloride
	2. 20.4 grams methanol
	3. 36 grams potassium hydroxide

Summary: Trinitroanisole is easily prepared by reacting picryl chloride with methanol, and potassium hydroxide. The trinitroanisole is then collected by filtration. Commercial & Industrial note: Part or parts of this laboratory process may be protected by international, and/or commercial/industrial processes. Before using this process to legally manufacture the mentioned explosive, with intent to sell, consult any protected commercial or industrial processes related to, similar to, or additional to, the process discussed in this procedure. This process may be used to legally prepare the mentioned explosive for laboratory, educational, or research purposes.

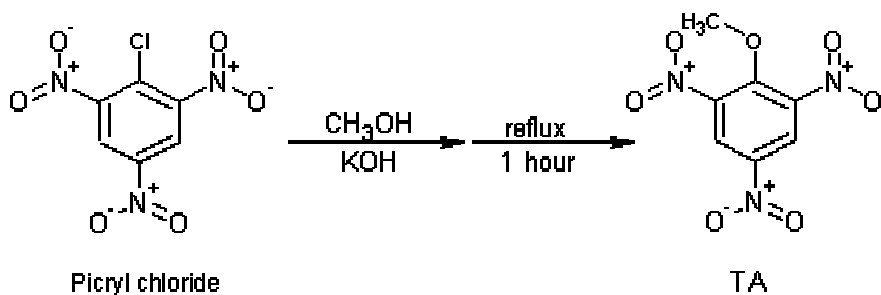
*Reaction Equation*

Procedure: Place 156 grams of picryl chloride, and 20.4 grams of methanol into a reflux apparatus. Then prepare a 50% potassium hydroxide solution by dissolving 36 grams of potassium hydroxide into 36 grams of water (much heat is evolved when potassium hydroxide is dissolved in water, so after dissolving the potassium hydroxide, allow the solution to cool to room temperature before using). When the potassium hydroxide solution is at room temperature, heat the picryl chloride mixture in the reflux apparatus to 65 Celsius. Then when the temperature reaches 65 Celsius, slowly add, drop wise, the 50% potassium hydroxide solution over a period of 90 minutes while stirring the contents in the reflux apparatus. After addition of the 50% potassium hydroxide solution, continue heating the mixture at 65 Celsius for 2 hours while strongly stirring. After 2 hours, remove the heat source, and allow the mixture to cool to room temperature. After which, add the entire reaction mixture into 1500 milliliters of cold water. Then filter-off the TA product, wash with 1500 milliliters of water several times, and then vacuum dry or air dry.

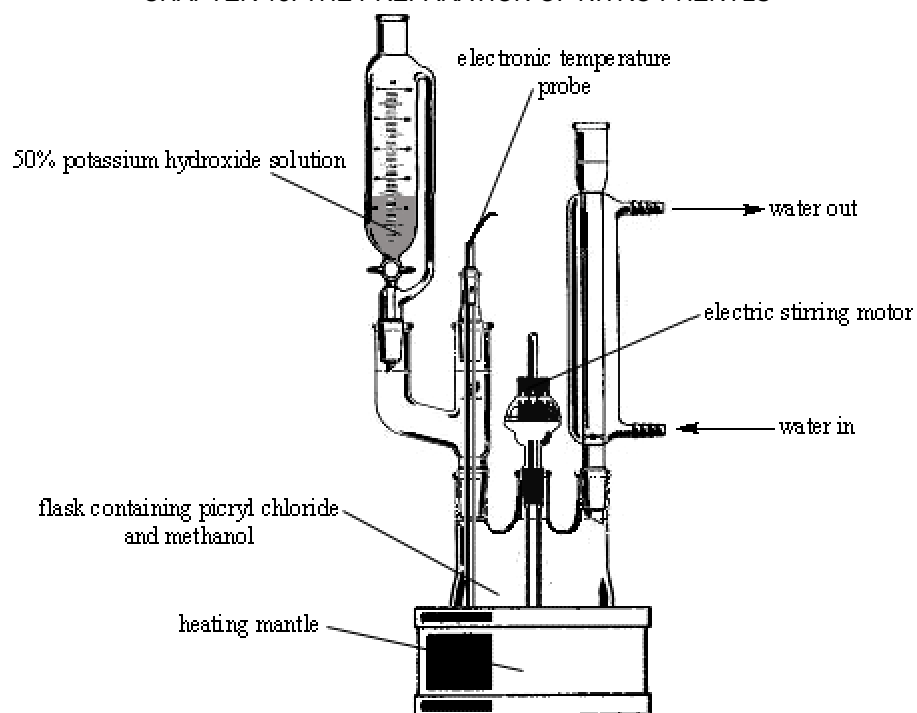

Figure 065. Reflux apparatus for preparation of TA.

Notes:

CHAPTER 19: THE PREPARATION OF NITRO PHENYL SALTS

LEAD-TNP, BARIUM STYPHANTE, LEAD STYPHNATE, AMMONIUM PICRAMATE, AMMONIUM PICRATE, LEAD PICRATE, SODIUM PICRAMATE

19-01. Lead-TNP. *Trinitrophenol lead salt*

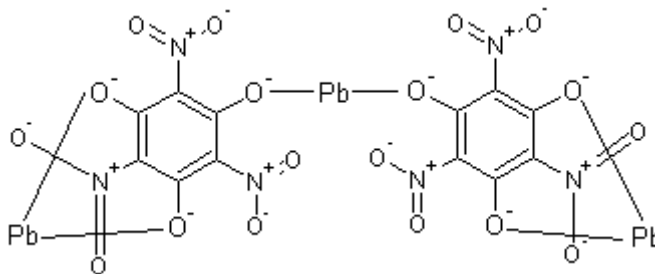

Lead-TNP

Uses: Lead-TNP is used in initiating compositions in place of lead styphnate or diazodinitrophenol for blasting caps and detonators, in priming compositions in place of mercury fulminate or in combination with sulfur nitride, triazoles, or tetrazoles, for use in bullet primers and the like. Lead-TNP can also be used in fireworks to detonate black powder for increased bursting effects in aerial shells. Lead-TNP should be handled with care. Never store dry, and keep submerged in a water free solvent such as kerosene for prolonged storage. Lead-TNP can be desensitized by mixing with dextrose, lead phosphate, lead chloride, sucrose, starch, or oils.

Molecular weight: 1065.69	Flammability: Explodes when ignited
Detonating velocity: Uncalculated	Toxicity: Moderate
Sensitivity: High	Classification: Primary explosive
Stability: Moderate	Overall value (as primary explosive): Moderate

Procedure 19-01A: Preparation of Lead-TNP

Materials:	1. 80 grams of phloroglucinol
	2. 114 milliliters glacial acetic acid
	3. 135 grams sodium nitrite
	4. 320 grams lead nitrate

Summary: The lead salt of phloroglucinol is prepared by treating the sodium salt with lead nitrate at 60 Celsius. The sodium salt is easily prepared by nitrating phloroglucinol with sodium nitrite in the presence of glacial acetic acid. The sodium salt is then filtered-off, placed into an excess of water, and then treated with the nitrate. The lead salt is then filtered-off, washed, and dried. Commercial & Industrial note: For related, or similar information, see Serial No. 301,955, October 30th, 1939, by Western cartridge Company, to William B. Woodring, Alton, ILL.. Part or parts of this laboratory process may be protected by international, and/or commercial/industrial processes. Before using this process to legally manufacture the mentioned explosive, with intent to sell, consult any protected commercial or industrial processes related to, similar to, or additional to, the process discussed in this procedure. This process may be used to legally prepare the mentioned explosive for laboratory, educational, or research purposes.

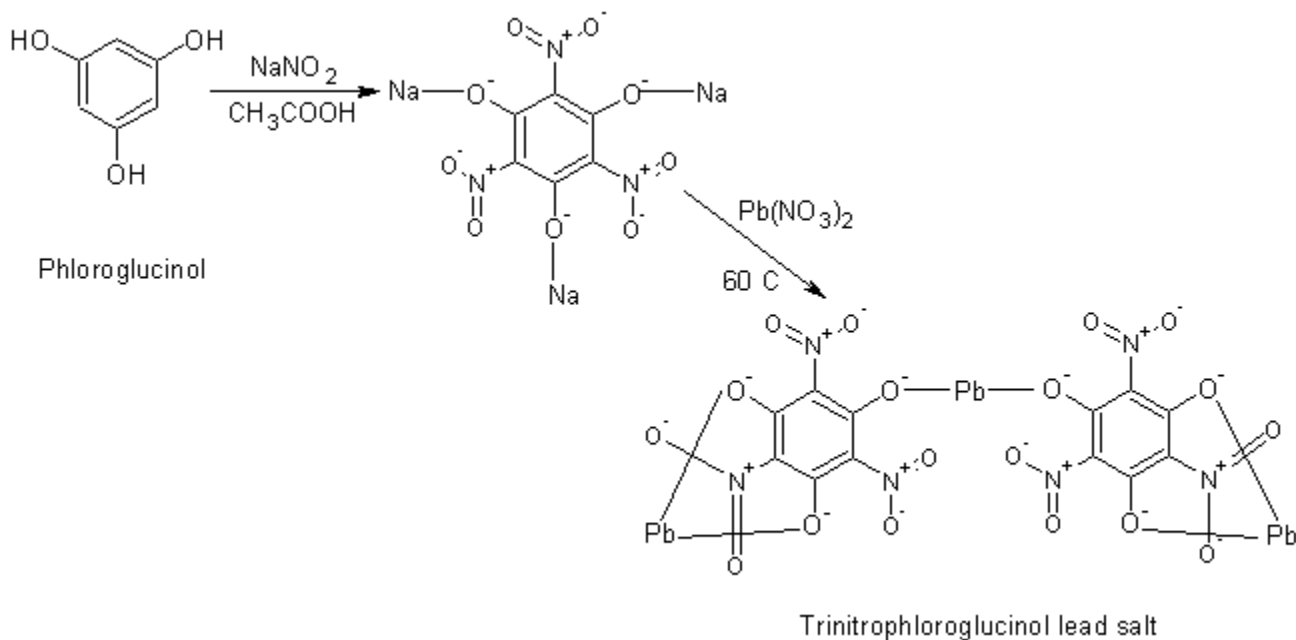

Hazards: Wear gloves when handling glacial acetic acid; although glacial acetic acid is considered a weak acid, it may cause skin irritation on prolonged exposure. Lead nitrate may be a carcinogen, so do not handle with bare hands.

Procedure:

Step 1: Preparation of the sodium salt

Into a suitable flask, add 80 grams of phloroglucinol, then 1600 milliliters of water, 114 milliliters of glacial acetic acid, and then 200 milliliters diethyl ether. Thereafter, place this mixture into an ice bath and chill to 5 Celsius. Then, prepare a solution by dissolving 135 grams sodium nitrite into 800 milliliters of water, and then chill this solution to 0 Celsius by means of an ice bath. Thereafter, add drop-wise, the sodium nitrite solution to the phloroglucinol solution over a period of 1 hour. During the addition, stir the phloroglucinol solution rapidly, and keep its temperature at 5 Celsius. After the addition, continue to stir the reaction mixture at 5 Celsius for 20 minutes. Thereafter, add in small portions, 220 grams of sodium hydroxide at such a rate as to keep the reaction mixtures temperature below 15 Celsius. During the addition, stir the reaction mixture rapidly. After the addition, cool the reaction mixture to 5 Celsius, and allow it to stand at such temperature for 10 minutes. Then, filter-off the precipitated solid, and then vacuum dry or air-dry. Thereafter, place 500 milliliters of water into a beaker, and then add the dried filtered-off solid. Then heat this mixture to 60 Celsius with stirring for about 20 minutes, and then remove the heat source and allow the mixture to cool to room temperature. Thereafter, filter-off the insoluble solid, and the vacuum dry or air-dry.

Step 2: Preparation of the lead salt

Place 2 liters of water into a beaker, and then add all the dried sodium salt obtained in step 1. Then heat this mixture to 60 Celsius with stirring. Then dissolve 320 grams of lead nitrate into 1400 milliliters of water, and then slowly add drop-wise, this lead nitrate solution to the sodium salt solution. During the addition, stir the sodium salt solution, and keeps its temperature around 60 Celsius. After the addition, remove the heat source and allow the reaction mixture to cool to room temperature. During the cool down period, continue to rapidly stir the reaction mixture. Afterwards, filter-off the precipitated lead salt, wash with 500 hundred milliliters of cold water, and then vacuum dry or air-dry the lead salt. The result will be 252 grams of the lead salt.

Notes:

This mixture may be used in electric blasting caps to initiate the RDX base charge. This eliminates the need for a lead azide booster, or lead styphnate/barium chromate ignition mixture as seen in the standard US military blasting caps discussed under RDX. The lead wires from the electric wires pass through this mixture in the usual manner. Into a mixing drum, add 100 grams of Lead-TNP, 80 grams of potassium chlorate, and 20 grams lead thiocyanate. Thereafter, thoroughly blend the mixture for several hours to obtain a uniform mixture. After the mixing process, remove the material, and then pack into a standard blasting cap above the RDX base charge; the lead electric wires should be in place before adding this mixture. A small electric current from a 9-volt battery is sufficient to initiate the mixture. Commercial & Industrial note: Part or parts of this laboratory process may be protected by international, and/or commercial/industrial processes. Before using this process to legally manufacture the mentioned explosive, with intent to sell, consult any protected commercial or industrial processes related to, similar to, or additional to, the process discussed in this procedure. This process may be used to legally prepare the mentioned explosive for laboratory, educational, or research purposes.

19-02. Barium Styphnate

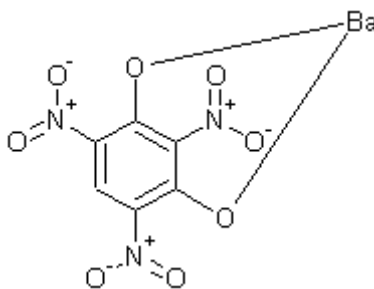

Barium Styphnate

Barium Styphnate forms yellow, uniform crystals. The crystals are stable, but may detonate if strongly heated and they deflagrate on ignition. Barium styphnate is well suitable for use in priming compositions for bullets and the like, in pyrotechnic compositions, and rocket propellants. Barium styphnate however, is primarily used as a substitute for lead styphnate in initiation compositions. Barium styphnate should be stored submerged in kerosene.

Molecular weight: 253.898	Flammability: Flashes when ignited
Detonating velocity: Uncalculated	Toxicity: Moderate
Sensitivity: Moderate	Classification: Primary explosive
Stability: Good	Overall value (as primary explosive): Moderate

Procedure 19-02A: Preparation of Barium Styphnate

Materials:	1. 20 grams Styphnic acid
	2. 20 milliliters 28 to 30% ammonia solution
	3. 20 grams barium chloride dihydrate
	4. 100 milliliters acetone

Summary: Barium styphnate is easily prepared by reacting styphnic acid with ammonia solution forming ammonium styphnate. This ammonium styphnate is then converted into the water insoluble barium styphnate by addition of barium chloride dihydrate. The product is then filtered-off, washed, and then dried. Commercial & Industrial note: For related, or similar information, see Serial No. 360,756, July 28th, 1970, by Atlas Chemical Industries, to Harold F. Bluhm, Tamaqua PA. Part or parts of this laboratory process may be protected by international, and/or commercial/industrial processes. Before using this process to legally manufacture the mentioned explosive, with intent to sell, consult any protected commercial or industrial processes related to, similar to, or additional to, the process discussed in this procedure. This process may be used to legally prepare the mentioned explosive for laboratory, educational, or research purposes.

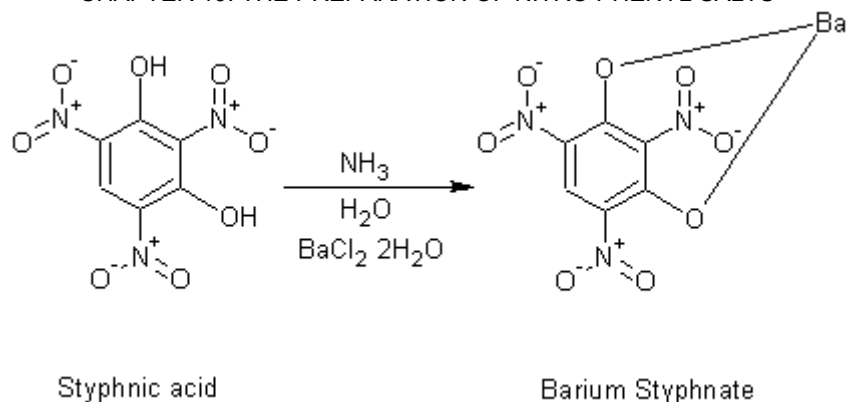
*Reaction Equation*

Hazards: Concentrated ammonia solution is very strong irritant. Use proper ventilation, and avoid inhalation of vapors.

Procedure: Add and dissolve 20 milliliters of 28 to 30% ammonium solution into 400 milliliters of water. Thereafter, add 20 grams of styphnic acid, and stir the mixture vigorously for about 20 minutes (at the end of 20 minutes, a clear solution will result). Then, heat the mixture to 80 Celsius. While the mixture begins to heat-up to 80 Celsius, prepare a solution by adding and dissolving 20 grams of barium chloride dihydrate into 150 milliliters of water. When the styphnic acid mixture reaches about 80 Celsius, add the barium chloride dihydrate solution over a period of about 4 minutes while constantly stirring the styphnic acid mixture. Note: a yellow precipitate will form immediately after the first addition of the barium chloride dihydrate. After the addition of the barium chloride dihydrate solution, remove the heat source and allow the reaction mixture to cool to room temperature. Then place the reaction mixture into a cold-water bath for 30 minutes. Afterwards, filter-off the precipitated product, wash with 200 milliliters of water, 100 milliliters of acetone, and then vacuum dry or air-dry the product. The result will be a yellow solid with very uniform particle size.

Notes:

19-03. Lead Styphnate. 2,4,6-trinitro-lead-II-resorcinatate

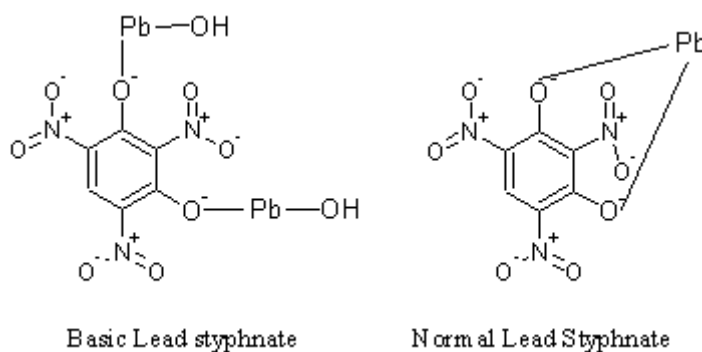

Lead Styphnate has several forms: 1) The amorphous basic lead styphnate forms a yellowish powder, needle-like crystals, or granules, 2) the red basic lead styphnate forms reddish or reddish-brown square prisms, or reddish hexagonal plates, and 3) the normal lead styphnate forms yellowish-orange crystals. All these forms of lead styphnate detonate when heated to about 260 Celsius. All forms are an excellent initiating explosive for use in blasting caps, and detonators. They are also widely used in the preparation of priming mixtures for a variety of applications. All forms of lead styphnate are sensitive to shock, heat, friction, and percussion, but the red basic lead styphnate tends to be the most unstable form. For use in initiation (ignition) compositions, all forms should be desensitized with small amounts of gum Arabic, sulfur, carbon black, dextrose, magnesium

CHAPTER 19: THE PREPARATION OF NITRO PHENYL SALTS

sulfate, or starch and mixed with an oxidizer such as barium chromate, lead chromate, copper permanganate, copper perchlorate, or magnesium dichromate.

Molecular weight: 691.501 and 450.287	Flammability: Explodes when ignited
Detonating velocity: 7300 to 7600	Toxicity: Moderate
Sensitivity: High	Classification: Primary explosive
Stability: Moderate	Overall value (as primary explosive): Very high

Procedure 19-03A: Preparation of Yellow basic Lead styphnate

Materials:	1. 24.4 grams styphnic acid
	2. 16 grams sodium hydroxide
	3. 100 grams lead-II-nitrate

Summary: The basic yellow lead styphnate is prepared by precipitating the salt from a styphnic acid/sodium hydroxide solution with lead nitrate at 100 Celsius. The resulting precipitated lead styphnate is then collected by filtration, washed, and dried. Commercial & Industrial note: Part or parts of this laboratory process may be protected by international, and/or commercial/industrial processes. Before using this process to legally manufacture the mentioned explosive, with intent to sell, consult any protected commercial or industrial processes related to, similar to, or additional to, the process discussed in this procedure. This process may be used to legally prepare the mentioned explosive for laboratory, educational, or research purposes.

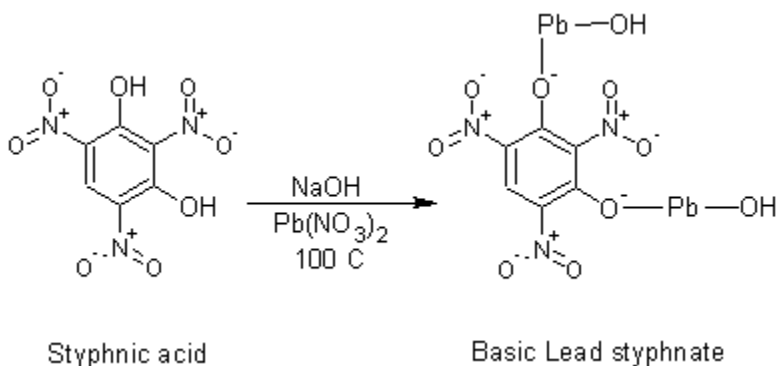

Reaction Equation

Hazards: Wear gloves when handling lead nitrate. Lead nitrate may be a carcinogen.

Procedure: Place 1500 milliliters of water into a beaker, and then add and dissolve 24.4 grams of styphnic acid, and then 16 grams of sodium hydroxide. Then, heat this mixture to 100 Celsius with stirring. Then, prepare a solution by dissolving 100 grams of lead nitrate into 2500 milliliters of water, and then add drop-wise the styphnic acid/sodium hydroxide solution to the lead nitrate solution as a steady drip, while stirring the lead nitrate solution. The rate of addition should be as such that the styphnic acid/sodium hydroxide mixtures temperature does not fall below 90 Celsius. Note: Simply place the heated styphnic acid/sodium hydroxide solution into a dropping funnel while it's boiling hot, and then begin the addition. After the addition, stir the reaction mixture for about 20 minutes, and then filter-off the precipitated lead styphnate. After filtering, allow the basic lead styphnate to cool to room temperature. Thereafter, wash with 200 milliliters of cold water, and then vacuum dry or air-dry.

Notes:

Procedure 19-03B: Preparation of Red basic Lead styphnate

Materials:	1. 24.4 grams styphnic acid
	2. 16 grams sodium hydroxide
	3. 70 grams lead-II-nitrate

Summary: The red basic lead styphnate is prepared by the interaction of a styphnic acid/sodium hydroxide solution with lead nitrate at 70 Celsius. In this case, the lead nitrate solution is less dilute, facilitating the formation of the red modification. During the first addition, a yellow precipitate forms during which time the addition of the styphnic acid/sodium hydroxide mixture is stopped. This precipitate is allowed to settle into reddish-brown diamond shaped crystals, where upon the addition is continued. After the addition, the precipitate is filtered-off, washed, and then dried. Commercial & Industrial note: For related, or similar information, see Serial No. 367,610, November 28th, 1940, by Remington Arms Company, to Willi Brun, Bridgeport CONN. Part or parts of this laboratory process may be protected by international, and/or commercial/industrial processes. Before using this process to legally manufacture the mentioned explosive, with intent to sell, consult any protected commercial or industrial processes related to, similar to, or additional to, the process discussed in this procedure. This process may be used to legally prepare the mentioned explosive for laboratory, educational, or research purposes.

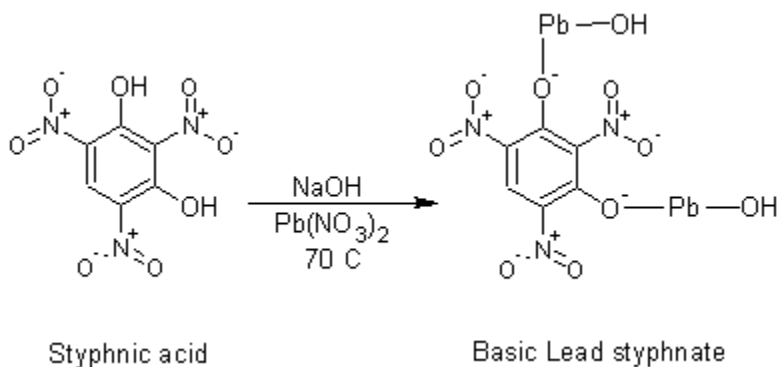

Reaction Equation

Hazards: Wear gloves when handling lead nitrate. Lead nitrate may be a carcinogen.

Procedure: Place 800 milliliters of water into a beaker, and then add, while rapidly stirring the water, 24.4 grams of styphnic acid, and then 16 grams of sodium hydroxide. Then, heat this mixture to 70 Celsius while stirring. Then dissolve 70 grams of lead nitrate into 700 milliliters of water. Thereafter, place the heated styphnic acid/sodium hydroxide into a dropping funnel, and then slowly add, drop-wise, drop-by-drop the styphnic acid/sodium hydroxide mixture into the lead nitrate solution while stirring the lead nitrate. Now, in the beginning, slowly add the styphnic acid/sodium hydroxide mixture very slowly, drop-by-drop until a small amount of an amorphous yellow precipitate forms. When this happens, stop the addition, and allow this amorphous yellow solid to crystallize as reddish-brown diamond shaped crystals. Where upon, add the styphnic acid/sodium hydroxide mixture at a much faster pace, and continue the addition until all the styphnic acid/sodium hydroxide mixture has been added. During the whole operation, stir the lead nitrate solution. After the addition, continue to stir the reaction mixture for 20 minutes, and then filter-off the precipitated lead styphnate. Allow it to cool to room temperature, and then wash with 200 milliliters of cold water, followed by vacuum drying or air-drying.

Notes:

Procedure 19-03C: Preparation of Normal Lead styphnate

Materials:	1. 182 grams styphnic acid
	2. 74 grams magnesium carbonate
	3. 248 grams lead nitrate
	4. 2.2 milliliter of 70% nitric acid

Summary: Lead styphnate is easily prepared by reacting a lead nitrate solution with a solution of magnesium styphnate. When the two solutions are mixed, the lead styphnate precipitates. Vacuum filtration is then used for isolating the lead styphnate. Commercial & Industrial note: Part or parts of this laboratory process may be protected by international, and/or commercial/industrial processes. Before using this process to legally manufacture the mentioned explosive, with intent to sell, consult any protected commercial or industrial processes related to, similar to, or additional to, the process discussed in this

procedure. This process may be used to legally prepare the mentioned explosive for laboratory, educational, or research purposes.

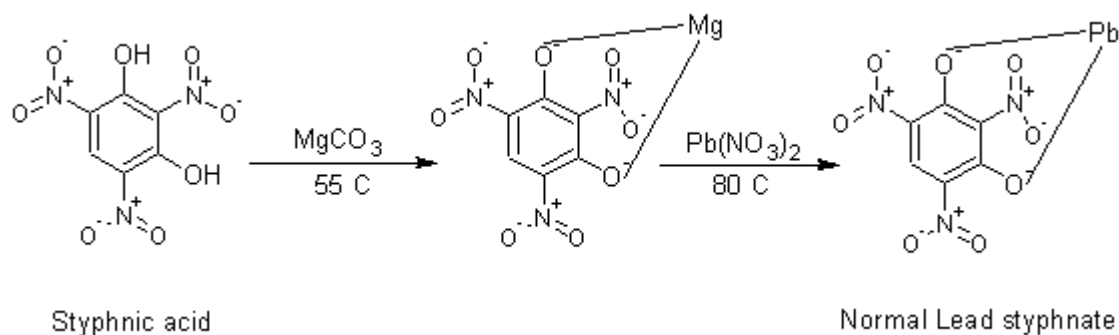

Reaction Equation

Procedure:

Step 1: Preparation of magnesium styphnate

Add 182 grams of styphnic acid to 466 milliliters of distilled water, and then heat the mixture to 45 Celsius. When the temperature reaches 45 Celsius, add 74 grams magnesium carbonate in small quantities while stirring the mixture. Gas evolution will begin immediately. After the addition of some of the magnesium carbonate, raise the temperature to 55 Celsius and continue adding the magnesium carbonate in small quantities while continuously stirring the mixture. After the addition of the magnesium carbonate, remove the heat source and allow the solution to cool to room temperature. Then add cold water to the reaction mixture until its total volume equals 732 milliliters. After which, filter the reaction mixture to remove any insoluble impurities. After filtration, add 2.2 milliliters of 70% nitric acid while stirring the filtered reaction mixture.

Step 2: Preparation of lead nitrate solution

Prepare a lead nitrate solution by adding 248 grams of crystalline lead nitrate to 670 milliliters of distilled water. Then warm the solution to 50 Celsius while stirring. Continue stirring the mixture until all the lead nitrate has dissolved. When all the lead nitrate has dissolved, cool the solution to room temperature and then filter to remove any insoluble impurities.

Step 3: Preparation of lead styphnate

Place 132 milliliters of the magnesium styphnate solution (prepared in step 1) into a flask and heat to 80 Celsius while stirring. Then slowly add 114 milliliters of the lead nitrate solution (prepared in step 2) over a period of 40 minutes while maintaining the temperature of the magnesium styphnate solution at 80 Celsius and stirring. After addition of the lead nitrate solution, continue heating the mixture at 80 Celsius for 10 minutes and then remove the heat source, and allow the mixture to cool to room temperature. Afterwards, filter-off the lead styphnate precipitate, and then wash with 1000 milliliters of water. Then vacuum dry or air-dry the product (no heat).

Notes:

19-04. Ammonium Picramate. *Ammonium 2-amino-4,6-dinitrophenolate; Ammonium-2-amino-4,6-dinitropicrate*

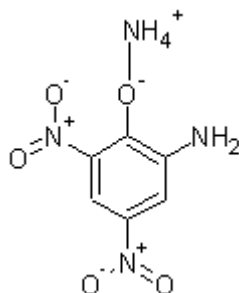

Ammonium picramate

Ammonium picramate forms highly flammable crystals, which ignite easily and burn violently. The crystals are easily detonated by heat, sparks, shock, flame, and percussion. Ammonium picramate like similar compounds are used extensively in priming mixtures for bullets and the like, initiation (ignition) charges for blasting caps and detonators, fireworks and other pyrotechnic compositions, and in high performance gun propellants and rocket propellants. Ammonium picramate should be stored submerged in kerosene.

Molecular weight: 216.153	Flammability: Highly flammable (deflagrates)
Detonating velocity: Uncalculated	Toxicity: Moderate
Sensitivity: High	Classification: Primary explosive
Stability: Moderate	Overall value (as primary explosive): High

Procedure 19-04A: Preparation of Ammonium picramate

Materials:	1. 400 grams picric acid
	2. 230 grams 13% ammonia solution
	3. 2948 grams 9% ammonium bisulfide solution
	4. 300 milliliters carbon disulfide

Summary: Ammonium picramate is the ammonium salt of picramic acid, and is made by reducing picric acid with ammonium bisulfide and ammonia solution. Sulfur is a by-product and must be removed with carbon disulfide. The sulfur/carbon disulfide solution can be distilled to recover the carbon disulfide solvent, and recover the sulfur by-product. The ammonium picramate is recovered by filtration. Commercial & Industrial note Part or parts of this laboratory process may be protected by international, and/or commercial/industrial processes. Before using this process to legally manufacture the mentioned explosive, with intent to sell, consult any protected commercial or industrial processes related to, similar to, or additional to, the process discussed in this procedure. This process may be used to legally prepare the mentioned explosive for laboratory, educational, or research purposes.

Hazards: Wear gloves and use proper ventilation when handling ammonium bisulfide, and ammonia solutions. Warning! Wear gloves and use proper ventilation when handling carbon disulfide. Carbon disulfide is a highly volatile, and toxic substance. Handle with care.

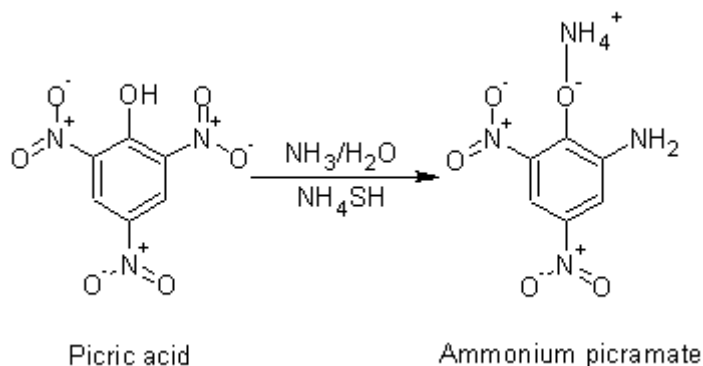

Reaction Equation

CHAPTER 19: THE PREPARATION OF NITRO PHENYL SALTS

Procedure: Into a flask, place 400 grams of picric acid, and then add about 100 grams of water. Then stir the mixture to form a paste. Thereafter, rapidly add 230 grams of 13% ammonia solution while stirring the paste. After the addition of the 13% ammonia solution, stir the mixture for 20 minutes, and then place the flask into an ice bath and cool to 0 Celsius. When the mixture reaches 0 Celsius, slowly add 2948 grams of a 9% ammonium bisulfide solution over a period of 4 hours while keeping the reaction mixture at 0 Celsius and stirring. After the addition of the 9% ammonium bisulfide solution, filter-off the blood red semi-solid mass, and then wash (several times with the same washing portion) with six 50-milliliter portions of carbon disulfide (to remove the sulfur and other impurities). After the washing, vacuum dry or air-dry the product. Note: The carbon disulfide can be recycled by distillation.

Notes:

19-05. AP. Ammonium Picrate

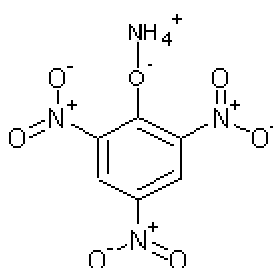

AP

Ammonium picrate forms bright yellow scales, or orthorhombic crystals, which are insoluble in water. The crystals explode easily from heat, shock, friction, fire, and percussion. Ammonium picrate is commonly used in priming compositions for bullets and the like, initiation compositions for blasting caps and detonators, high performance rocket propellants, and fireworks and other pyrotechnic compositions. Ammonium picrate should be stored submerged in kerosene.

Molecular weight: 246.135	Flammability: Flammable—may flash when ignited
Detonating velocity: 6500	Toxicity: Low
Sensitivity: High	Classification: Primary explosive
Stability: Moderate	Overall value (as primary explosive): High

Procedure 19-05A: Preparation of AP

Materials:	1. 400 milliliters of benzene
	2. 6 grams of dry ammonia
	3. 38 grams of picric acid

Summary: Ammonium picrate is prepared by treating picric acid with ammonia in benzene solution. The ammonium picrate precipitates and is collected by filtration. Commercial & Industrial note: Part or parts of this laboratory process may be protected by international, and/or commercial/industrial processes. Before using this process to legally manufacture the mentioned explosive, with intent to sell, consult any protected commercial or industrial processes related to, similar to, or additional to, the process discussed in this procedure. This process may be used to legally prepare the mentioned explosive for laboratory, educational, or research purposes.

Hazards: Benzene is a suspected carcinogen. Wear gloves and use proper ventilation when handling benzene. Use care when handling ammonia.

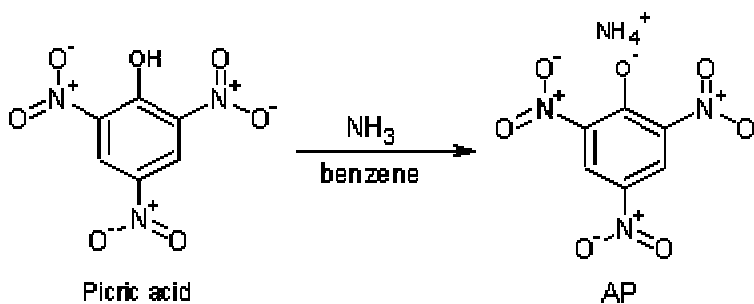
*Reaction Equation*

Procedure: Bubble 3 grams of ammonia gas into 400 milliliters of benzene. Then, stir the mixture while slowly adding and dissolving 38 grams of finely divided (powdered) picric acid. Keep the reaction mixture at room temperature (a cold water bath may or may not be needed). While slowly adding the picric acid, bubble another 3 grams ammonia gas into the reaction mixture. After the addition of the ammonia gas and the picric acid, stir the solution for 2 hours at room temperature. The ammonium picrate will begin to separate shortly after the first couple of additions of the picric acid. After 2 hours, filter-off the ammonium picrate, wash with 500 milliliters of water, and then vacuum dry or air-dry the product. Do not use heat to dry the ammonium picrate.

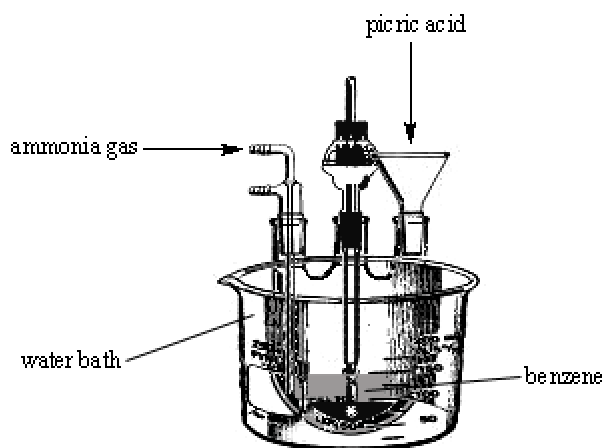
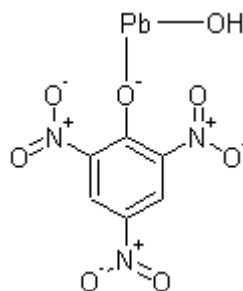

Figure 066. Set-up for ammonium picrate preparation.

Notes:

19-06. Lead Picrate. 2,4,6-Trinitro-lead-phenolate basic



Lead picrate

Use: Same as for ammonium picrate. Lead picrate should be stored submerged in kerosene.

Molecular weight: 452.303	Flammability: Explodes when ignited
Detonating velocity: Similar to ammonium picrate	Toxicity: Moderate
Sensitivity: High	Classification: Primary explosive
Stability: Moderate	Overall value (as primary explosive): Moderate

Procedure 19-06A: Preparation of Lead picrate

Materials:	1. 9.2 grams of picric acid
	2. 80 milliliters of 4% sodium hydroxide solution
	3. 15 grams lead nitrate

Summary: Lead picrate is easily prepared by simply mixing solutions of sodium picrate and lead nitrate. The sodium picrate is prepared on-site by the action of sodium hydroxide upon picric acid. The precipitated basic lead picrate is then filtered-off, washed, and dried. Commercial & Industrial note: For related, or similar information, see Serial No. 523,562, December 19th, 1921, by Walter Friederich, Treisdorf, Germany. Part or parts of this laboratory process may be protected by international, and/or commercial/industrial processes. Before using this process to legally manufacture the mentioned explosive, with intent to sell, consult any protected commercial or industrial processes related to, similar to, or additional to, the process discussed in this procedure. This process may be used to legally prepare the mentioned explosive for laboratory, educational, or research purposes.

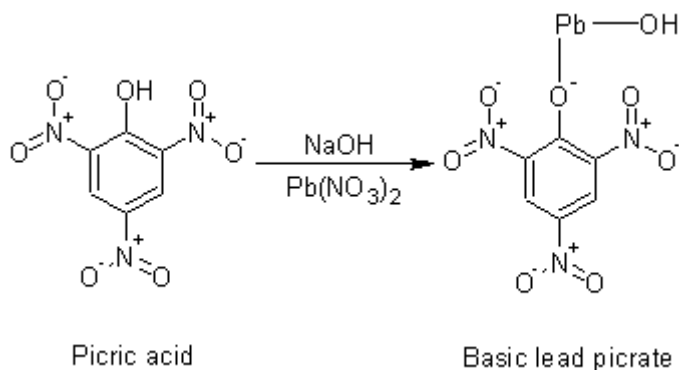

Reaction Equation

Hazards: Wear gloves when handling lead nitrate. Lead nitrate may be a carcinogen.

Procedure: Place 80 milliliters of a 4% sodium hydroxide solution into a flask, and then quickly add 9.2 grams of picric acid. Shortly thereafter, add 320 milliliters of water. Then dissolve 15 grams of lead nitrate into 600 milliliters of water, and then heat this mixture to 80 Celsius. Thereafter, Add drop-wise, the picric acid mixture to the lead nitrate solution over a period of 1 hour. During the addition, rapidly stir the lead nitrate solution and keep its temperature at 80 Celsius. After the addition, remove the heat source, and allow the reaction mixture to cool to room temperature. During the cool down period, rapidly stir the reaction mixture. Afterwards, filter-off the precipitated lead picrate, wash with several hundred milliliters of cold water, and then vacuum dry or air-dry the product.

Notes:

Lead picrate initiating mixture

The following compound is used in place of lead styphnate, lead azide, mercury fulminate, or diazodinitrophenol in their respective places in the standard blasting cap as indicated under explosive munitions of RDX. To prepare: Simply mix 160 grams of freshly prepared wet basic lead picrate with 20 grams of potassium chlorate, and 20 grams lead tetraoxide. Thoroughly blend the mixture in a porcelain dish to form a well defined, thoroughly mixed composition. The well-blended

mixture will have a distinctive red color; vide supra lead tetraoxide. Afterwards, pack the mixture into a steel tube that is the exact diameter of the desired blasting cap, and only 1/5th the total length there of (the idea here is to form a pellet of this initiating mixture, so the pellet can be placed on top of the blasting caps main charge; RDX. This eliminates the need to “press” this initiating composition into the blasting cap), and then cure for several days at room temperature. Then, remove the “pellet”, and simply slide it into your desired blasting cap. Commercial & Industrial note: Part or parts of this laboratory process may be protected by international, and/or commercial/industrial processes. Before using this process to legally manufacture the mentioned explosive, with intent to sell, consult any protected commercial or industrial processes related to, similar to, or additional to, the process discussed in this procedure. This process may be used to legally prepare the mentioned explosive for laboratory, educational, or research purposes.

19-07. Sodium picramate. *Ammonium 2-amino-4,6-dinitrophenolate; Ammonium-2-amino-4,6-dinitropicrate*

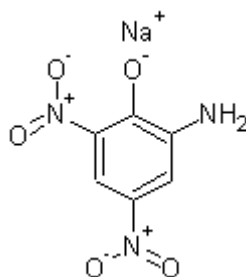

Sodium picramate

Sodium picramate forms stable crystals, which ignite rapidly and burn violently. The crystals are used in priming compositions for bullets and the like, initiation compositions for blasting caps and detonators, high performance rocket propellants, fireworks and a variety of pyrotechnics compositions for flares, incendiaries, and signals. It is also used as an intermediate in the production of other high explosives. Sodium picramate should be stored submerged in kerosene.

Molecular weight: 221.104	Flammability: Highly flammable (deflagrates)
Detonating velocity: Uncalculated	Toxicity: Moderate
Sensitivity: High	Classification: Primary explosive
Stability: Moderate	Overall value (as primary explosive): Moderate

Procedure 19-07A: Preparation of Sodium picramate

Materials:	1. 800 grams of picric acid
	2. 70 grams of sodium hydroxide
	3. 2948 grams of 9% ammonium bisulfide solution
	4. 300 milliliters of carbon disulfide

Summary: Sodium picramate can be prepared by reacting picric acid with sodium hydroxide, and then reducing the picric acid salt to the picramate by treatment with ammonium bisulfide. After treatment with the ammonium bisulfide, the reaction mixture is filtered to remove the product. The product is then treated with carbon disulfide to dissolve precipitated sulfur. The product is then washed, and then dried. Commercial & Industrial note: Part or parts of this laboratory process may be protected by international, and/or commercial/industrial processes. Before using this process to legally manufacture the mentioned explosive, with intent to sell, consult any protected commercial or industrial processes related to, similar to, or additional to, the process discussed in this procedure. This process may be used to legally prepare the mentioned explosive for laboratory, educational, or research purposes.

Hazards: Warning! Wear gloves and use proper ventilation when handling carbon disulfide. Carbon disulfide is a highly poisonous liquid, and it can be absorbed through the skin. Use proper care when handling. Wear gloves when handling sodium hydroxide and ammonium bisulfide, which can both cause skin irritation. Ammonium bisulfide can cause hair removal with irritation, and reddening.

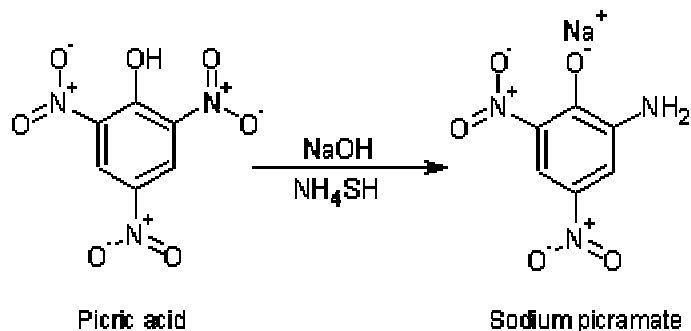
*Reaction Equation*

Procedure: Into a flask, place 400 grams of picric acid, and then add about 100 grams of water to form a paste. Then prepare a solution by dissolving 70 grams of sodium hydroxide into 400 milliliters of water. After adding the sodium hydroxide to the water, allow the solution to cool to room temperature, and then rapidly add this sodium hydroxide solution to the picric acid paste while vigorously stirring the paste. After the addition of the sodium hydroxide solution, continue stirring the mixture for 20 minutes. Afterwards, place the reaction mixture into an ice bath, and cool to 0 Celsius. After which, slowly add 2948 grams of 9% ammonium bisulfide solution over a period of 4 hours while keeping the reaction mixture at 0 Celsius and stirring. After the addition of the 9% ammonium bisulfide solution, filter-off the product, and then wash the product (several times with the same washing portion) with six 50-milliliter portions of carbon disulfide (to remove the sulfur and other impurities). After washing the product with carbon disulfide, vacuum dry or air-dry the product. Note: The carbon disulfide can be recovered by distillation.

Notes:

CHAPTER 20: THE PREPARATION OF NITRATES, CHLORATES, AND PERCHLORATES

AN, AC, APC, PCB, Nitro-PCB, EDDN

20-01. AN. Ammonium Nitrate

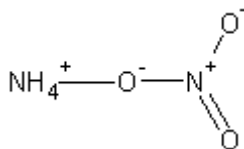

AN

Ammonium nitrate forms odorless, transparent, hygroscopic, and deliquescent crystals or white granules. It decomposes at 210 Celsius into water and nitrous oxide (laughing gas). Ammonium nitrate is very soluble in water, and alcohol. It is widely available commercially, and is available in a number of products including fertilizers and garden products. For use in explosives, AN is commonly used admixed with fuel oil, diesel fuel, TNT, oils, and aluminum for explosives compositions. Ammonium nitrate mixed with oils and fuels are commonly called prills, and are highly stable mixtures widely used in mining and engineering operations. Because ammonium nitrate prills are quite stable for long-term storage and they yield no noxious fumes upon detonation, they are called “safety explosives”. Ammonium nitrate and TNT are commonly used as military dynamites, and blasting charges for military engineering purposes. Ammonium nitrate should be stored in tightly sealed, amber glass bottles, or non-transparent plastic containers in a well-cooled area protected from sunlight.

Molecular weight: 80.043	Flammability: Non flammable
Detonating velocity: 4100	Toxicity: Very low
Sensitivity: Very low	Classification: Secondary explosive
Stability: Very good	Overall value (as secondary explosive): Extremely high

Procedure 20-01A: Preparation of AN

Materials:	1. 206 grams 70% nitric acid
	2. 40 grams dry ammonia gas or 136 grams of 28 - 30% ammonia solution or 400 grams of 10% ammonia solution (store bought ammonia; crystal clear ammonia)
	3. 1460 milliliters methanol

Summary: Ammonium nitrate is easily prepared by dissolving ammonia gas, or water solutions of ammonia into dilute nitric acid at low temperature. The ammonium nitrate is recovered by recrystallization from the water.

Hazards: Wear gloves when handling 70% nitric acid. 70% Nitric is highly toxic and corrosive. Use proper ventilation when handling ammonia gas, or its solutions.

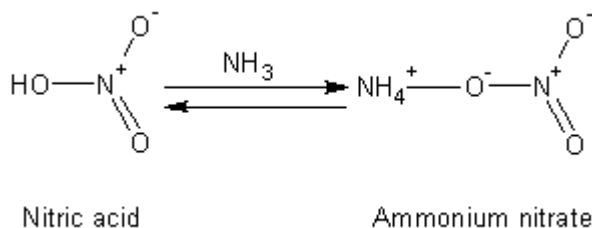

Reaction Equation

CHAPTER 20: THE PREPARATION OF NITRATES, CHLORATES, AND PERCHLORATES

Procedure: Dissolve 206 grams of 70% nitric acid into 600 milliliters of water. Then cool the diluted nitric acid solution to 0 Celsius by means of an ice bath while stirring continuously. Next, bubble 40 grams of ammonia gas into the nitric acid mixture over a period of one hour while stirring and maintaining the reaction mixtures temperature at 0 Celsius. Or slowly add 136 grams of 28 – 30% ammonia solution, or 400 grams of a 10% ammonia solution into the diluted nitric acid solution while stirring and maintaining the diluted nitric acids temperature at 0 Celsius. Upon completion of the ammonia addition, recrystallize the ammonium nitrate from the reaction mixture, and then vacuum dry or air dry the product. If a rotary evaporator is available, place the filtered reaction mixture there into, and remove the water under high vacuum. Then, recrystallize the ammonium nitrate from methanol (2 grams ammonium nitrate dissolves in 16 milliliters methanol), and then vacuum dry or air-dry the product. The product will weigh about 180 to 188 grams and will be of 99% purity. Recrystallizing the ammonium nitrate from methanol is not necessary if the ammonium nitrate is to be used in making prills. If the ammonium nitrate is to be alloyed with sensitive high explosives such as picric acid, picric acid salts, styphnic acid, or styphnic acid salts, the ammonium nitrate should be recrystallized from methanol.

Notes:

Procedure 20-01B: Preparation of AN

Materials:	1. 1000 grams sodium nitrate
	2. 740 grams of 28 - 30% ammonia solution or 2000 grams of 10% ammonia solution (store bought ammonia; crystal clear ammonia) or 200 grams dry ammonia gas
	3. 7200 milliliters methanol
	4. 3530 grams of dry carbon dioxide (lecture bottle) or 3000 grams of dry ice

Summary: Ammonium nitrate is easily prepared by dissolving sodium nitrate into water, adding ammonia, and then passing in an excess of carbon dioxide gas (dry may be used if desired). The resulting insoluble sodium bicarbonate is then filtered-off, and the ammonium nitrate is recovered by recrystallization from the water.

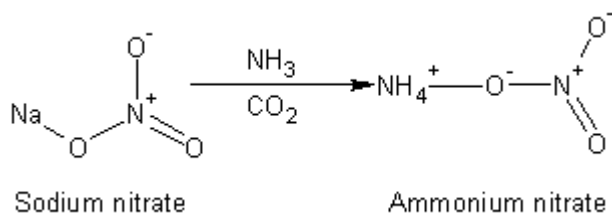

Reaction Equation

Hazards: Use proper ventilation when handling ammonia gas, or its solutions, and avoid inhalation of vapors.

Procedure: Dissolve 1000 grams of sodium nitrate into 2300 milliliters of water. Then add 740 grams of 28 – 30% ammonia solution, or 2000 grams of 10% ammonia solution, or pass 200 grams of anhydrous ammonia into the nitrate solution while stirring the nitrate solution. Thereafter, place this mixture into an ice bath, and chill to 0 Celsius. Then, pass 3530 grams of dry carbon dioxide into the reaction mixture at a steady rate while stirring the reaction mixture and maintaining its temperature at 0 Celsius, or add in pieces, 3000 grams of dry ice. After the carbon dioxide addition, continue to stir the reaction mixture for 30 minutes at 0 Celsius, and then filter-off the precipitated sodium bicarbonate. Thereafter, recrystallize the ammonium nitrate from the reaction mixture. If a rotary evaporator is available, place the filtered reaction mixture there into, and remove the water under high vacuum. After the recrystallization process, vacuum dry or air-dry the crystals. Then, recrystallize the ammonium nitrate from methanol (2 grams ammonium nitrate dissolves in 16 milliliters methanol), and then vacuum dry or air-dry the product. Recrystallizing the ammonium nitrate from methanol is not necessary if the ammonium nitrate is to be used in making prills. If the ammonium nitrate is to be alloyed with sensitive high explosives such as picric acid, picric acid salts, styphnic acid, or styphnic acid salts, the ammonium nitrate should be recrystallized from methanol.

Notes:

Ammonium nitrate and aluminum blasting prill

Add 209 grams of guar gum to 482 grams of finely divided aluminum powder coated with a thin coating of polytetrafluoroethylene, and manually blend for 1 hour. Then add 516 milliliters of cold water to 9.5 kilograms of ammonium nitrate, and manually blend the mixture for 1 hour. Afterwards, add the guar gum and powdered aluminum mixture to the ammonium nitrate mixture, and then add 2 liters of cold water while manually blending the whole mixture vigorously. After addition of the water, manually blend for an additional 1 hour. After blending for 1 hour, the explosive is ready for use. To use the explosive, simply press it into any desirable mold, container, bomb casing, or warhead casing under high pressure. For demolition or blasting purposes, pack the explosive into plastic or cardboard tubes, or plastic weatherproof bags. Requires blasting cap or detonator for initiation. *Detonating velocity: 2700 to 3000 meters per second. Suitable for mining, and rock blasting.* Commercial & Industrial note: For related, or similar information, see Application No. 404,764, August 3, 1982, by Energy Sciences Partners, Ltd., to Michel E. Maes, King County, WA, Robert L. Shaw, Dallas County, TX, and Royal L. Reinsch, King County, WA. Part or parts of this laboratory process may be protected by international, and/or commercial/industrial processes. Before using this process to legally manufacture the mentioned explosive, with intent to sell, consult any protected commercial or industrial processes related to, similar to, or additional to, the process discussed in this procedure. This process may be used to legally prepare the mentioned explosive for laboratory, educational, or research purposes.

Ammonium nitrate blasting composition

First, prepare a mixture by adding 8900 grams of ammonium nitrate and 2600 grams of sodium nitrate into 2 liters of water, and then manually blend for 1 hour. Then prepare a second mixture by mixing 60 grams of thiourea, 30 grams of guar gum, 68 grams of ethylene glycol, 2700 grams of ammonium nitrate, 500 grams of pregelled starch (made by heating starch with water), 100 grams of sodium carboxymethylcellulose, 1160 grams of urea, and 1400 grams of aluminium powder. Then blend this mixture manually for 2 hours. Afterwards, add this second mixture to the first mixture, and rapidly blend manually for 2 hours. After 2 hours, add 80 grams of sodium nitrite, 600 grams of finely divided TNT and 2 grams of zinc chromate, and then blend the mixture rapidly for 2 hours. After 2 hours, place the mixture onto a shallow pan, and allow it to dry. Thereafter, the explosive composition is ready for use. To use, simply press into any desirable mold, container, bomb casing, or warhead casing under high pressure. For demolition or blasting purposes, pack the explosive into any plastic or cardboard tube, or pack into a weather proof bag. Requires blasting cap or detonator for initiation. *Detonating velocity: 3000 to 4000 meters per second. Suitable for hard rock mining, and rock blasting.* Commercial & Industrial note: Part or parts of this laboratory process may be protected by international, and/or commercial/industrial processes. Before using this process to legally manufacture the mentioned explosive, with intent to sell, consult any protected commercial or industrial processes related to, similar to, or additional to, the process discussed in this procedure. This process may be used to legally prepare the mentioned explosive for laboratory, educational, or research purposes.

“ANFO” Ammonium nitrate fuel oil explosive

Thoroughly blend 960 grams of ammonium nitrate with 40 grams of diesel fuel oil at room temperature for several hours to provide a well-mixed fuel balanced explosive. The resultant mixture will be in form of a tacky, water impermeable slurry. Use the slurry directly and do not allow it to dry. Pack the slurry tightly into any desirable mold, container, bomb casing, or warhead casing under mild pressure (by-hand). For mining purposes, the slurry can be directly poured into the boreholes for blasting. Requires blasting cap or detonator for initiation. *Detonating velocity: 3500 to 4000 meters per second. Standard ammonium nitrate blasting composition. Suitable for use in standard rock mining, and rock blasting.*

“ANFO B” Modified ammonium nitrate fuel oil explosive

Into a beaker, place 3500 grams of urea and then 3500 grams of ammonium nitrate, and then manually blend the solids for 20 minutes. Then slowly heat the beaker to exactly 60 Celsius. When the mixture becomes fluid-like, continue manually stirring for 1 hour. After 1 hour, add 50 grams of a thickening agent (available commercially from General Mills Incorporated under the designation "Gengel" E2), and manually stir the mixture for 20 minutes. Afterwards, add 10 grams of sodium nitrite, 140 grams of diesel fuel oil and 20 grams of zinc chromate, and then manually stir the mixture rapidly for 10 minutes. Then slowly add 12860 grams of ammonium nitrate, and then manually stir the mixture for 1 hour. After 1 hour, remove the heat source, and then pour the fluid mixture into any desirable mold, container, bomb casing, or warhead casing under high pressure, and

CHAPTER 20: THE PREPARATION OF NITRATES, CHLORATES, AND PERCHLORATES

then cure for several days. For use in demolitions, remove the mold or container after curing, and then wrap the solid explosive in paper, plastic, or cardboard. Requires blasting cap or detonator for initiation. *Detonating velocity: 2800 to 3000 meters per second. Suitable for standard rock mining, and rock blasting.* Commercial & Industrial note: For related, or similar information, see Application No. 847,052, October 31, 1977, by ICI Australia Limited, to George H. Barnett, North Balwyn, AU. Part or parts of this laboratory process may be protected by international, and/or commercial/industrial processes. Before using this process to legally manufacture the mentioned explosive, with intent to sell, consult any protected commercial or industrial processes related to, similar to, or additional to, the process discussed in this procedure. This process may be used to legally prepare the mentioned explosive for laboratory, educational, or research purposes.

Ammonium nitrate black powder

Into a mixing drum, add 600 grams of pure dry ammonium nitrate, 100 grams of pure sublimed sulfur, 178 grams of charcoal, 100 grams of sodium nitrate, 12 grams of calcium carbonate, and 10 grams of urea. Thereafter, pour in 200 milliliters of kerosene, and then thoroughly blend the mixture for several hours at room temperature. After the blending operation, remove the materials from the mixing drum, and then place into an extruding machine, containing multiple 1 to 2 millimeter holes, and extrude the propellant into strands 5 to 10 centimeters long. Thereafter, cut the strands into pieces 1 to 2 millimeters in diameter. Thereafter, place the granules onto a shallow pan, and allow them to cure for several days. After which time, they are ready for use. To use, simply pour them into any desirable cartridge casing. Use standard gun casing primers for initiation. Commercial & Industrial note: Part or parts of this laboratory process may be protected by international, and/or commercial/industrial processes. Before using this process to legally manufacture the mentioned explosive, with intent to sell, consult any protected commercial or industrial processes related to, similar to, or additional to, the process discussed in this procedure. This process may be used to legally prepare the mentioned explosive for laboratory, educational, or research purposes.

Explosive munitions of Ammonium nitrate

Ammonium nitrate is a weak explosive (meaning its pressure wave is not very powerful). A pressure wave is the energy force generated when explosives detonate. The greater the pressure wave, the more destructive the explosive is. Because ammonium nitrate has a weak pressure wave, its role in warfare is limited; although, its use in peacetime operations is significant. Explosives with weak pressure waves have great “heaving” action, which mean they tend to throw debris rather than blow it apart. In mining operations, ammonium nitrate explosives are most often used to prevent possible ‘blowing apart’ of the rock, which can lead to cave-ins. Many deaths have resulted in mining due to using high explosives. In this regards, ammonium nitrate based explosives have replaced high explosives such as TNT, and the nitroglycerine dynamites to minimize mining accidents. When it comes to demolitions, ammonium nitrate is often used in conjunction with a high explosive to create not only a “heaving” action, but a “blowing apart” action as well. In the following demolition munition, upper and lower ammonium nitrate pellets are situated next to a central TNT booster pellet. A blasting cap is used to initiate the TNT booster, which then detonates the ammonium nitrate. The TNT acts as the destructor, blowing the debris apart, and the ammonium nitrate acts as the heaver, throwing the debris aside.

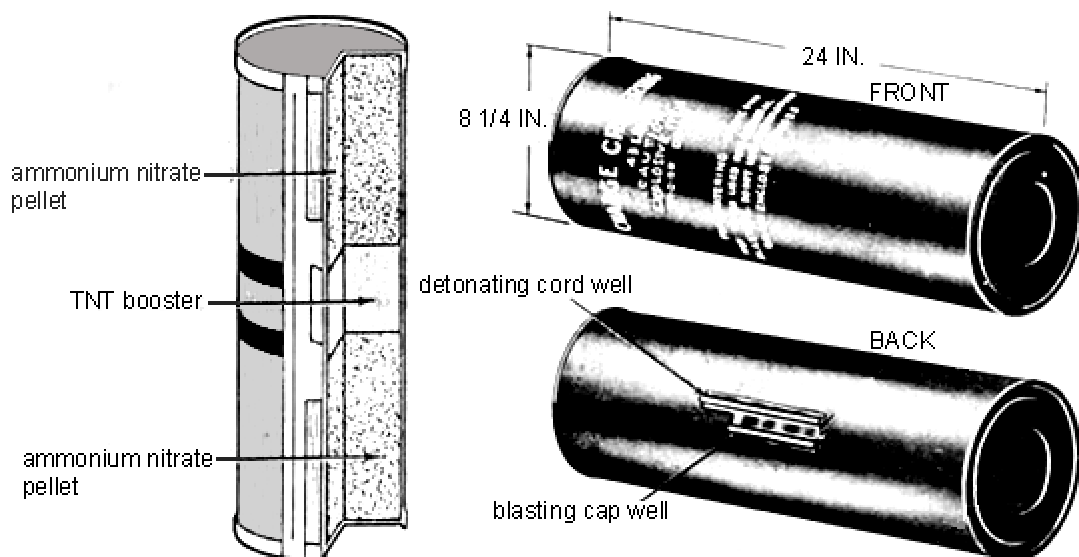
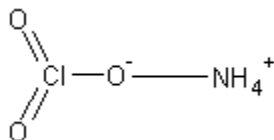

Figure 067. Standard US Army ammonium nitrate based blasting munition. See TM 43-0001-38 for additional information.

20-02. AC. Ammonium chlorate



AC

AC forms colorless crystals or a white powder. AC is very soluble in water, and as a result, this decreases the popularity for its use. The salt can detonate by percussion or shock, but is relatively stable. It can be used in making initiation compositions when mixed with heavy metal chromates, perchlorates, or dichromates for use in blasting caps or detonators. AC can also be used in making priming mixtures with primary explosives for use in bullets etc. AC is primarily used in fireworks, and a variety of pyrotechnic compositions. It is also heavily used in high performance rocket propellants alone, or mixed with its perchlorate with aluminum or other powdered metals. AC is a strong oxidizer, and mixtures with combustible materials ignite rapidly and violently.

Molecular weight: 101.489	Flammability: Non flammable—may flash when ignited
Detonating velocity: Similar to AN	Toxicity: Very low
Sensitivity: Moderate	Classification: Secondary explosive
Stability: Moderate	Overall value (as secondary explosive): Moderate

Procedure 20-02A: Preparation of AC

Materials:	1. 174 grams of a 28 - 30% ammonia solution or 450 grams of 10% ammonia (store bought ammonia; crystal clear ammonia) or 48 grams of anhydrous ammonia gas
	2. 1000 grams of dry carbon dioxide gas (lecture bottle) or 900 grams of dry ice
	3. 300 grams sodium chlorate

Summary: Ammonium chlorate is prepared in a similar manner as other inorganic ammonium salts, by the precipitation of metal ions with carbon dioxide. In this case, sodium chlorate is treated with ammonia, and carbon dioxide is then passed there into. The carbon dioxide reacts with the water forming carbonic acid. The carbonic acid reacts with the sodium chlorate forming the water insoluble sodium bicarbonate. The ammonia molecules in solution take up an acidic hydrogen from the carbonic acid, and then unite with the chlorate ions forming ammonium chlorate in solution. The salt is then easily recovered by recrystallization.

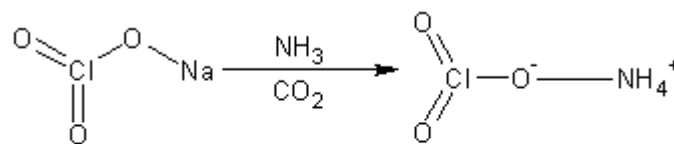

Sodium chlorate

AC

Reaction Equation

Hazards: Use proper ventilation when handling ammonia, either anhydrous or its solutions, and avoid inhalation of the vapors.

Procedure: Dissolve 300 grams of sodium chlorate into 720 milliliters of water. Then add 174 grams of 28 – 30% ammonia solution, or 450 grams of 10% ammonia solution, or pass 48 grams of anhydrous ammonia into the chlorate solution while stirring the chlorate solution. Thereafter, place this mixture into an ice bath, and chill to 0 Celsius. Then, pass 1000 grams of dry carbon dioxide into the reaction mixture at a steady rate while stirring the reaction mixture and maintaining its temperature at 0 Celsius, or add in small pieces, 900 grams of dry ice. After the carbon dioxide addition, continue to stir the reaction mixture for 30 minutes at 0 Celsius, and then filter-off the precipitated sodium bicarbonate. Thereafter, recrystallize the ammonium chlorate from the reaction mixture. Note: Do not over recrystallize the ammonium chlorate from the reaction

CHAPTER 20: THE PREPARATION OF NITRATES, CHLORATES, AND PERCHLORATES

mixture; this means only remove about 80% of the water during the recrystallization process. If a rotary evaporator is available, place the filtered reaction mixture there into, and remove the water under high vacuum. If boiling the mixture at 100 Celsius during the recrystallization process causes some decomposition of the ammonium chlorate, place the filtered reaction mixture into a shallow pan, and heat the pan at 50 Celsius while blowing air over the surface of the liquid. Do this until dry solid remains (a small portable cooling fan can be used). After the recrystallization process, vacuum dry or air-dry the crystals, and store them in an amber glass bottle in a cool dry place.

Notes:

20-03. APC. *Ammonium perchlorate*

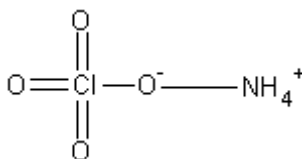

APC

Ammonium perchlorate forms colorless orthorhombic crystals or white powder. The crystals decompose when heated into oxygen and ammonium chloride. The crystals are very soluble in water. Ammonium perchlorate has limited use in explosive compositions, but its use in propellants is overwhelming. Ammonium perchlorate is heavily used in solid rocket propellants when mixed with aluminum or other metals or reducing agents and a polymer binder. The salt is a strong oxidizer, and should be kept away from combustible materials and sources of possible ignition. Note: A disastrous explosion in the Nevada desert in the late 1980's was a result of poor containment and storage of ammonium perchlorate crystals. As expected, mixtures of APC and any combustible agent ignite rapidly and violently. Store ammonium perchlorate in tightly sealed bottles in a cool place, and away from sunlight.

Molecular weight: 117.488	Flammability: Non flammable (decomposes when ignited)
Detonating velocity: Uncalculated	Toxicity: Low
Sensitivity: Low	Classification: Secondary explosive
Stability: Good	Overall value (as secondary explosive): Extremely high

Procedure 20-03A: Preparation of APC

Materials:	1. 320 grams of a 28 - 30% ammonia solution or 900 grams of 10% ammonia solution (store bought ammonia; crystal clear ammonia) 96 grams anhydrous ammonia gas
	2. 1300 grams dry carbon dioxide gas (lecture bottle) or 1000 grams of dry ice
	3. 470 grams sodium perchlorate

Summary: Ammonium perchlorate is prepared by adding a concentrated ammonia solution to a concentrated solution of sodium perchlorate, and then passing carbon dioxide into the solution over several hours to precipitate the sodium as the water insoluble sodium bicarbonate. The ammonium perchlorate remains in solution, and the solution is then filtered. Thereafter, the ammonium perchlorate is then collected by recrystallization.

Hazards: Wear gloves and use proper ventilation when handling 28 - 30% ammonia.

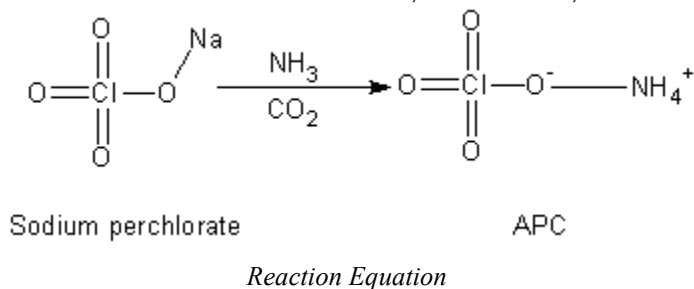

Procedure: Dissolve 470 grams of sodium perchlorate into 1000 milliliters water. Then quickly add 320 grams of a 28 - 30% ammonia solution, or 900 grams of 10% ammonia solution, or pass 96 grams of anhydrous ammonia gas into the perchlorate solution while stirring the sodium perchlorate solution. Afterwards, Cool the mixture to 0 Celsius by means of an ice bath. Then bubble 1300 grams of dry carbon dioxide gas into the mixture over a several hour period while keeping the reaction temperature at 0 Celsius and stirring, or add in pieces, 1000 grams of dry ice. During the carbon dioxide gas addition, sodium bicarbonate will slowly precipitate (if dry ice is used, precipitation of the sodium bicarbonate will be more rapid). After all the carbon dioxide has been added, continue to stir the reaction mixture for 90 minutes at 0 Celsius, and then filter the reaction mixture to remove the insoluble sodium bicarbonate. After filtration, recrystallize the ammonium perchlorate from the filtered mixture at 100 Celsius. Note: during the recrystallization process, do not over recrystallize. This means when most of the ammonium perchlorate has been collected by filtration, do not boil-off all the remaining water to the point where dry solid remains. Dry ammonium perchlorate may decompose if heated above 70 Celsius. If boiling the mixture at 100 Celsius during the recrystallization process causes some decomposition of the ammonium perchlorate, place the filtered reaction mixture into a shallow pan, and heat the pan at 50 Celsius while blowing air over the surface of the liquid. Do this until dry solid remains (a small portable cooling fan can be used). Note: If a rotary evaporator is available, place the filtered reaction mixture there into, and then remove the water under high vacuum until dry solid remains.

Notes:

Ammonium perchlorate high performance rocket propellant (military grade solid rocket fuel)

Add 31 grams of a plastic elastomer (sold under the trade name Kraton 1107) into 50 grams of toluene while stirring the toluene. The elastomer readily dissolves in a few minutes at room temperature to form a clear solution. Next, add 600 milligrams of aziridine BA114 compound (commercially available), and then add 32 grams of aluminum powder with vigorous stirring of the toluene mixture, and after the addition of the aluminum, add 136 grams of ammonium perchlorate while maintaining strong stirring. After addition of the ammonium perchlorate, stir the mixture for 2 hours at room temperature. Afterwards, pour the mixture into a shallow pan with a high surface area and allow the toluene to evaporate (can take up to 3 days). After the odor of toluene is gone, remove the dry solid propellant and then chop it into tiny pieces. To use the propellant, place the chopped-up pieces of dry solid propellant into a beaker, and then heat to 150 Celsius until the propellant becomes a viscous liquid. Then pour the viscous liquid into any desirable mold or container (make sure the mold or container can withstand a temperature of 150 Celsius). Then cure the mold or container for several days at room temperature. After several days, the propellant can then be removed from the mold or container in one piece. The mold or container should be the same diameter and desired shape of the rocket motor body. The mold or container can act directly as the rocket motor body if desired, according to design and function. Note: Do not use a blasting cap or detonator for initiation. *High velocity solid propellant well suitable for rockets, and missiles. Note: In wartime a major drawback to this propellant is the amount of visible exhaust smoke produced. The exhaust will be a dense white smoke.* Commercial & Industrial note: For related, or similar information, see Application No. 272,859, June 12, 1981, by The United States Army, to Henry C. Allen, Decatur, AL. Part or parts of this laboratory process may be protected by international, and/or commercial/industrial processes. Before using this process to legally manufacture the mentioned explosive, with intent to sell, consult any protected commercial or industrial processes related to, similar to, or additional to, the process discussed in this procedure. This process may be used to legally prepare the mentioned explosive for laboratory, educational, or research purposes.

Ammonium perchlorate high performance rocket propellant (military grade solid rocket fuel)

CHAPTER 20: THE PREPARATION OF NITRATES, CHLORATES, AND PERCHLORATES

Add 17 grams of RB-810 (commercially available), 32 grams of dioctyl adipate (commercially available), and 1.6 grams of lecithin to a beaker, and then heat the beaker to 71 Celsius. Then rapidly blend the ingredients for 90 minutes at 71 Celsius. After 90 minutes, add 150 grams of ammonium perchlorate, and then continue heating and blending for 2 hours. Afterwards, press the explosive mixture into any desirable mold, container, or rocket motor and then cure the mold, container, or rocket motor at room temperature for 3 days. After curing, remove the propellant from the mold or container in one piece. The rocket motor should have the same shape and diameter as the mold or container. If you used a rocket motor directly instead of a mold or container, do not remove the propellant. Note: Do not use a blasting cap or detonator for initiation. *High velocity solid propellant well suitable for rockets, and missiles.* Commercial & Industrial note: For related, or similar information, see Application No. 903,000, September 2, 1986, by Morton Thiokol, Inc., to Rodney L. Willer, New London, PA, James A. Hartwell, Elkton, MD, and Robert G. Gleeson, Newark, DE. Part or parts of this laboratory process may be protected by international, and/or commercial/industrial processes. Before using this process to legally manufacture the mentioned explosive, with intent to sell, consult any protected commercial or industrial processes related to, similar to, or additional to, the process discussed in this procedure. This process may be used to legally prepare the mentioned explosive for laboratory, educational, or research purposes.

Ammonium perchlorate high performance rocket propellant (military grade solid rocket fuel)

Into a beaker, add 86 grams of polyethylene glycol, and 104 grams of NENA, and then thoroughly blend this mixture for 2 hours at room temperature. Thereafter, add in 200 grams of aluminum powder, and then thoroughly blend for 2 hours at room temperature. Finally, add in 510 grams of ammonium perchlorate, and 100 grams of ammonium nitrate, and thoroughly blend the mixture for 6 hours at room temperature. During all the blending operations, use a motorized stirrer with a plastic stir blade, preferably Teflon. After the blending, press the mixture into any desirable rocket motor or mold, and then cure for several days at room temperature. As before, the mold should be the same size and shape as the desired rocket motor, and the rocket motor can act directly as the mold or container, if desired. Note: Do not use a blasting cap or detonator for initiation. *High velocity solid propellant well suitable for rockets, and missiles. Note: In wartime a major drawback to this propellant is the amount of visible exhaust smoke produced. The exhaust will be a dense white smoke.* Commercial & Industrial note: Part or parts of this laboratory process may be protected by international, and/or commercial/industrial processes. Before using this process to legally manufacture the mentioned explosive, with intent to sell, consult any protected commercial or industrial processes related to, similar to, or additional to, the process discussed in this procedure. This process may be used to legally prepare the mentioned explosive for laboratory, educational, or research purposes.

20-04. PCB. Perchlorylbenzene

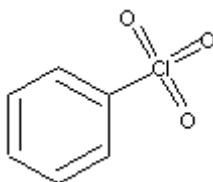

PCB

Perchlorylbenzene is an interesting and new line of future explosives that include perchloryl groups in combination with, or in place of nitro groups. The future of these compounds is unknown, but they definitely have interesting properties to warrant further research. This further research will most likely prove these compounds have a place in the future of explosives. PCB, like other similar compounds have greater energies than the corresponding nitro compounds because the central chlorine atoms within the perchloryl groups poses greater energy than do the corresponding central nitrogen's within the nitro groups. This greater energies provided overall superior explosives power, along with significant energy output. PCB has limited use as of right now, but it demonstrates outstanding ability to act not only as a high-energy plasticizer, but an explosives filler when admixed with nitrocellulose, or nitroglycerine for use in highly performance gun propellants, rockets propellants and explosives. PCB can also be used as a high-energy fuel additive for liquid rocket fuels, or as a fuel additive for racecars. Perchlorylbenzene is a colorless, oily liquid with a boiling point of 232 Celsius—it has a flash point of -3 Celsius.

Molecular weight: 160.556	Flammability: Flammable—may flash if strongly ignited
Detonating velocity: Uncalculated	Toxicity: Moderate
Sensitivity: Low	Classification: Secondary explosive
Stability: Good	Overall value (as secondary explosive): Low

Procedure 20-04A: Preparation of PCB

Materials:	1. 226 grams anhydrous aluminum chloride
	2. 5200 grams of benzene
	3. 200 grams perchloryl fluoride (obtained from Fluka/Aldrich/Sigma chemical co.; as a compressed gas in cylinders)

Summary: Perchlorylbenzene is prepared by reacting benzene with perchloryl fluoride gas in the presence of an acid catalyst, anhydrous aluminum chloride. The resulting reaction mixture is then mixed with excess water, and then steam distilled. The benzene fraction thus recovered is then evaporated to yield the crude oily yellow product. This product is then purified by vacuum distillation to achieve the high purity colorless oily product. Commercial & Industrial Note: For related, or similar information, see Serial No. 762,906, September 24th, 1958 by Pennsalt Chemicals Corporation, to Charles E. Inman, Glenside, PA., Robert E. Oesterling, Silver Spring, MD, and Edward A. Tyczkowski, Willow Grove, PA. Part or parts of this laboratory process may be protected by international, and/or commercial/industrial processes. Before using this process to legally manufacture the mentioned explosive, with intent to sell, consult any protected commercial or industrial processes related to, similar to, or additional to, the process discussed in this procedure. This process may be used to legally prepare the mentioned explosive for laboratory, educational, or research purposes.

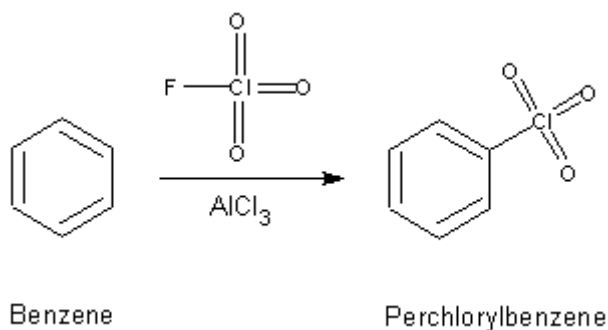

Reaction Equation

Hazards: Use caution when handling perchloryl fluoride; do not bring in contact with reducing agents or alcohols; explosions have resulted. Wear proper protective clothing to avoid skin burns, and do not inhale gas or vapors (will cause lung irritation). Do not inhale vapors of benzene; benzene is a known carcinogen. Wear gloves when handling anhydrous aluminum chloride; may cause skin irritation.

Procedure: Into a suitable flask, add 5200 grams of water free benzene, and then add and suspend 226 grams of anhydrous aluminum chloride. Then place the flask into a water bath. Afterwards, slowly bubble about 200 grams of perchloryl fluoride into the benzene mixture over a period suitable to complete the reaction (the bubbling speed of the perchloryl fluoride into the benzene determines the time; the bubbling speed should be slow). During the addition, maintain the benzene solution below 45 Celsius with constant stirring. During the addition, hydrogen chloride gas is steadily evolved; when the hydrogen chloride gas evolution has ceased, the reaction is over. When the addition of the perchloryl fluoride is complete, allow the reaction mixture to cool to room temperature, and then add 10000 milliliters of water. After which, place the entire mass into a steam distillation apparatus, and steam distil until no more benzene fraction passes into the receiver flask. Afterwards, remove the benzene fraction from the receiver flask, and then place it into a rotary evaporator, and evaporate-off the benzene under moderate vacuum. After the benzene has been removed, about 140 grams of a pale yellow product will be obtained. Then, place this pale yellow product into a vacuum distillation apparatus, and distill at about 70 to 100 Celsius (a higher temperature may be needed) under high vacuum until about 124 grams of a clear, oily liquid is obtained in the receiver flask.

Notes:

20-05. Nitro-PCB. 3-Nitroperchlorylbenzene

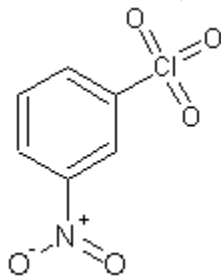

Nitro-PCB

3-Nitroperchlorylbenzene is another interesting substance of the PCB group that possesses explosive properties suitable for use in a variety of applications including high explosives, gun propellants, and high-energy fuel additive for solid rocket fuels. 3-Nitroperchlorylbenzene forms pale yellow needle shaped crystals with a melting point of 50 Celsius. The crystals can be alloyed with TNT, or other low melting secondary explosives for use in explosives compositions, warheads, or other munitions.

Molecular weight: 205.553	Flammability: Flammable—may flash if strongly ignited
Detonating velocity: Uncalculated	Toxicity: Moderate
Sensitivity: Low	Classification: Secondary explosive
Stability: Good	Overall value (as secondary explosive): Low

Procedure 20-05A: Preparation of Nitro-PCB

Materials:	1. 140 grams 70% nitric acid
	2. 1050 grams 98% sulfuric acid
	3. 200 grams perchlorylbenzene
	4. 410 grams benzene
	5. 410 grams petroleum ether

Summary: Nitroperchlorylbenzene can be prepared by reacting perchlorylbenzene with a nitrating acid mixture. The product is then recovered, and then recrystallized from a benzene/petroleum ether mixture. Commercial & Industrial Note: For related, or similar information, see Serial No. 762,906, September 24th, 1958 by Pennsalt Chemicals Corporation, to Charles E. Inman, Glenside, PA., Robert E. Oesterling, Silver Spring, MD, and Edward A. Tyczkowski, Willow Grove, PA. Part or parts of this laboratory process may be protected by international, and/or commercial/industrial processes. Before using this process to legally manufacture the mentioned explosive, with intent to sell, consult any protected commercial or industrial processes related to, similar to, or additional to, the process discussed in this procedure. This process may be used to legally prepare the mentioned explosive for laboratory, educational, or research purposes.

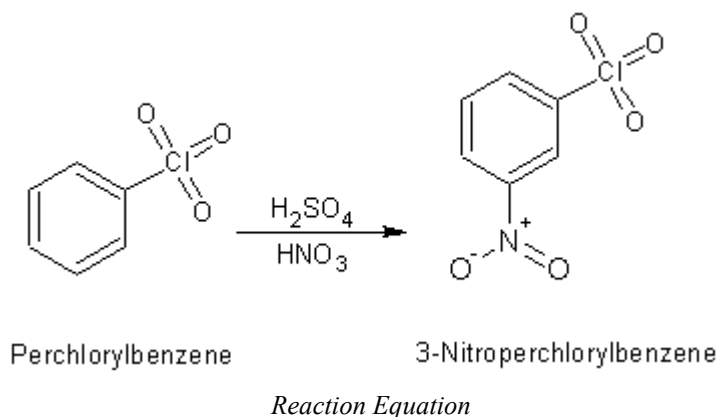

Hazards: Wear gloves when handling 98% sulfuric acid and 70% nitric acid; both can cause skin burns and irritation. Do not inhale benzene vapors; benzene is a known carcinogen.

Procedure: Into a suitable flask, add 800 grams of 98% sulfuric acid, and 200 grams of perchlorylbenzene. Then place this mixture into a cold-water bath. Afterwards, prepare a nitrating acid mixture by adding 250 grams of 98% sulfuric acid to 140

CHAPTER 20: THE PREPARATION OF NITRATES, CHLORATES, AND PERCHLORATES

grams of 70% nitric acid. Note: always add the sulfuric to the nitric, never the reverse. Then add this nitrating acid mixture to the perchlorylbenzene mixture over a period of 150 minutes while stirring and maintaining the perchlorylbenzene mixture below 30 Celsius. After the addition of the nitrating acid, stir the mixture below 30 Celsius for about 90 minutes. After 90 minutes, add the entire mixture to 1000 grams of ice, which is contained in a suitable beaker. After which, filter-off the precipitated product, wash with several portions of cold water, and then vacuum dry or air-dry. The result will be 220 grams of a crude product. Then dissolve this crude product into 820 grams of a solvent mixture prepared by mixing 410 grams of benzene with 410 grams of petroleum ether, and then recrystallize the product, then wash the collected crystals with several portions of cold water, and then vacuum dry or air-dry the product. The result will be high purity 3-nitroperchlorylbenzene in the form of needle shaped crystals with a pale yellow color.

Notes:

20-06. BDC. *Biguanide diperchlorate*

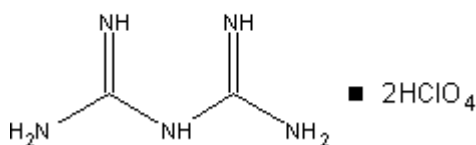

Biguanide diperchlorate

Biguanide diperchlorate forms white crystals with a melting point of 218 Celsius. The crystals are thermally stable, and can be alloyed with many other secondary explosives for use a variety of applications including explosives charges, warheads, and other munitions. Biguanide diperchlorate is an effective propellant either by itself, or when admixed with nitrocellulose, nitro starch, HMX, or nitroglycerine for use in high performance gun propellants, and rocket propellants. It is also very useful as a substitute for PETN in blasting cords and PETN compositions—BDC is more stable than PETN. Biguanide diperchlorate is impact insensitive, and is commonly used with ammonium nitrate and ethylenediamine dinitrate for use in melt cast compositions along with TATB for demolition charges, missile warheads, and mortar bombs.

Molecular weight: 302.027	Flammability: Flammable (may deflagrate on strong ignition)
Detonating velocity: 8490 (calculated)	Toxicity: Moderate
Sensitivity: Moderate	Classification: Secondary explosive
Stability: Good	Overall value (as secondary explosive): Moderate

Procedure 20-06A: Preparation of BDC

Materials:	1. 60 grams biguanide
	2. 1200 milliliters 95% ethanol
	3. 170 grams 70% perchloric acid
	4. 2500 milliliters ethyl acetate

Summary: BDC is prepared by neutralizing perchloric acid with biguanide, which is a strong base. The reaction mixture is then treated with ethyl acetate, and then evaporated. The white product is then collected by filtration, washed with ethyl acetate, and then dried. Commercial & Industrial note: For related, or similar information, see Application No. 195,991, July 20th, 1982, by The United States Navy, to Gail W. Lawrence, and Horst G. Adolph, both of Silver Springs, MD. Part or parts of this laboratory process may be protected by international, and/or commercial/industrial processes. Before using this process to legally manufacture the mentioned explosive, with intent to sell, consult any protected commercial or industrial processes related to, similar to, or additional to, the process discussed in this procedure. This process may be used to legally prepare the mentioned explosive for laboratory, educational, or research purposes.

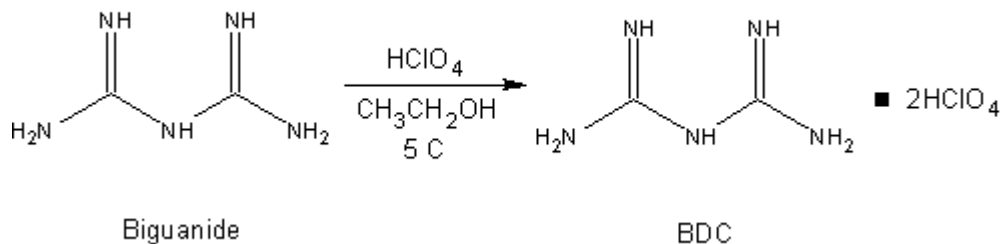
*Reaction Equation*

Hazards: Use extreme caution when handling 70% perchloric acid. Perchloric acid is a very strong oxidizing agent, and it may explode in contact with certain organic material; use great care.

Procedure: Dissolve 60 grams of biguanide into 1000 milliliters of 95% ethanol, and then cool this mixture to 5 Celsius by means of an ice bath. (Note: shortly after, some of the biguanide will recrystallize out; never mind this). Now dissolve 170 grams of 70% perchloric acid into 200 milliliters of 95% ethanol (take caution, add the perchloric acid to the ethanol slowly). Afterwards, slowly add this perchloric acid/ethanol solution to the biguanide mixture over a period of about 6 hours while keeping the reaction temperature around 5 Celsius. Note: After about 1/3 of the perchloric acid mixture has been added, the crystallized biguanide, formed earlier, will re-dissolve. After the addition of the perchloric acid mixture, add 1000 milliliters of ethyl acetate, and then place the mixture into a rotary evaporator; apply sufficient vacuum to evaporate the reaction mixture to “near” dryness: remove about 90% of the total volume. After which, add 500 milliliters of ethyl acetate, and then evaporate the reaction mixture using the same rotary evaporator to near dryness: remove about 90% of the total volume. After which, repeat the process once more using one last portion of ethyl acetate, 500 milliliters, and evaporating to near dryness: remove about 90% of the total volume. Now, remove the contents from the rotary evaporator, and filter-off any precipitated product. Then wash the product with 500 milliliters of ethyl acetate, and then vacuum dry or air dry the product. The result will be 160 grams of the product as a white solid. Note: If a rotary evaporator is not available, simply use a standard distillation apparatus to remove the ethyl acetate, and ethanol.

Notes:

20-07. EDDN. *Ethylenediamine dinitrate*

EDDN

EDDN forms white or colorless crystals, or powder with a melting point of 187 Celsius. The compound is a powerful explosive, which is used widely in rocket propellants, and explosive compositions.

Molecular weight: 186.124	Flammability: Flammable—may flash when ignited
Detonating velocity: Uncalculated	Toxicity: Low
Sensitivity: Low	Classification: Secondary explosive
Stability: Good	Overall value (as secondary explosive): Moderate

Procedure 20-07A: Preparation of EDDN

Materials:	1. 68 grams ethylenediamine
	2. 201 grams 70% nitric acid
	3. 2229 grams 95% ethanol

CHAPTER 20: THE PREPARATION OF NITRATES, CHLORATES, AND PERCHLORATES

Summary: EDDN is prepared from ethylenediamine by treatment with nitric acid. The EDDN is then recrystallized from ethanol. The ethanol is used to “salt out” the soluble EDDN from its water solution. Commercial & Industrial note: For related, or similar information, see Application No. 479,556, February 13, 1990, by Aerojet-General Corporation, to Robert E. Olsen, Placerville, CA, George D. Homer, Orangevale, CA, and James C. Barnard, Shingle Springs, CA. Part or parts of this laboratory process may be protected by international, and/or commercial/industrial processes. Before using this process to legally manufacture the mentioned explosive, with intent to sell, consult any protected commercial or industrial processes related to, similar to, or additional to, the process discussed in this procedure. This process may be used to legally prepare the mentioned explosive for laboratory, educational, or research purposes.

Hazards: Wear gloves when handling 70% nitric acid. 70% Nitric acid is strong oxidizing acid, and can cause skin irritation.

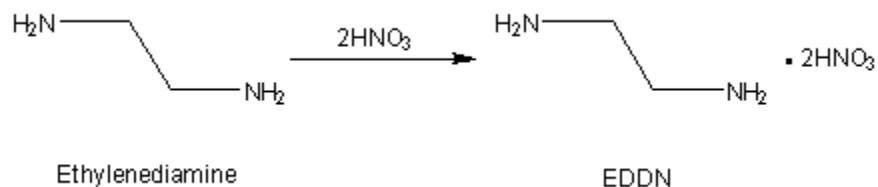

Reaction Equation

Procedure: To a round bottom flask fitted with a dropping funnel, stirrer, and thermometer, place 158 grams of water and 68 grams of ethylenediamine. Begin stirring the mixture and then add, drop wise, via the addition funnel, 201 grams of 70% nitric acid. Maintain the reaction temperature below 20 Celsius by means of a cold-water bath. After the addition of all the nitric acid, transfer the reaction mixture to another flask, and then cool this flask with an ice bath. Then add 1229 grams of 95% ethanol to a flask and then cool to 0 Celsius by means of an ice. When the 95% ethanol reaches about 0 Celsius, add it to the reaction mixture while stirring the reaction mixture. The ethylenediamine dinitrate precipitates as a white crystalline solid, forming a slurry. After the addition of the 95% ethanol, stir the slurry for 1 hour, and then filter-off the product. Afterwards, wash the filtered product with about 1,000 grams of 95% ethanol. After which, vacuum dry or air-dry the product. After drying, 179 grams of EDDN will be obtained. Note: the 95% ethanol can be recovered by double distillation.

Notes:

CHAPTER 21: THE PREPARATION OF NITRO PARAFFINS AND THEIR DERIVATIVES

NITROFORM, HNF, KNF, SILVER NITROFORM, TNM, TBA, TNB, 4,4-DNB, HNH-3, TNP, TNEN, NTND

21-01. Nitroform. *Trinitromethane*

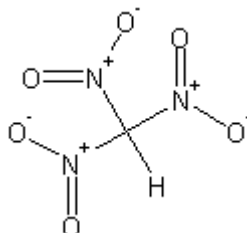

Nitroform

Nitroform forms colorless crystals with a melting point of 15 Celsius. At room temperature nitroform is a colorless, or slightly yellow, oily liquid. The pure product should be stored in amber glass bottles in a refrigerator until use. Nitroform tends to be unstable and may begin to decompose above 25 Celsius. It is widely used in the manufacture of other explosive compounds, propellant compositions, gun propellants, dynamites, as a high-energy plasticizer, and in making salts of nitroform, which are widely used in propellants, gunpowders, and fireworks. All salts of nitroform are made by neutralizing nitroform with metal carbonates or hydroxides. The lithium, sodium, potassium, magnesium, zinc, aluminum, iron, nickel, silver, and lead salts are known.

Molecular weight: 151.034	Flammability: Generally non flammable but may ignite
Detonating velocity: Uncalculated	Toxicity: Low
Sensitivity: Low	Classification: Secondary explosive
Stability: Moderate	Overall value (as secondary explosive): High

Procedure 21-01A: Preparation of Nitroform

Materials:	1. 700 milliliters 99% nitric acid
	2. 100 milliliters 99% isopropyl alcohol
	3. 2250 milliliters of methylene chloride
	4. 250 grams of anhydrous calcium chloride

Summary: Nitroform is easily prepared by reacting isopropyl alcohol with 99% nitric acid. The resulting reaction mixture is then extracted with methylene chloride, and then evaporated. Commercial & Industrial note: For related, or similar information, see Application No. 857,055, October 24, 1978, by Rockwell International Corporation, to Milton B. Frankel, Tarzana, CA, Frank C. Gunderloy Jr., Santa Susana, CA, Dean O. Woolery, II, Reseda, CA. Part or parts of this laboratory process may be protected by international, and/or commercial/industrial processes. Before using this process to legally manufacture the mentioned explosive, with intent to sell, consult any protected commercial or industrial processes related to, similar to, or additional to, the process discussed in this procedure. This process may be used to legally prepare the mentioned explosive for laboratory, educational, or research purposes.

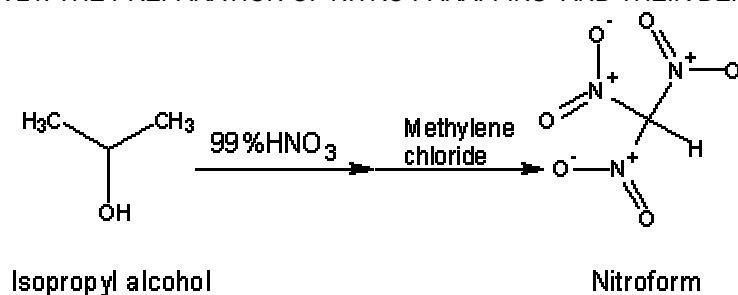
*Reaction Equation*

Hazards: Use great care when handling 99% nitric acid. 99% nitric is a highly corrosive and toxic liquid evolving highly poisonous fumes of nitrogen oxides. Wear gloves and use proper ventilation. Avoid inhalation of vapors.

Procedure: Note: This procedure uses an excessive amount of 99% nitric acid to properly carry out the reaction. This excessive amount of acid can be recovered by treating the reaction mixture (after complete removal of the product) with methylene chloride to recover the nitric acid. Prior to this action, a small amount of sulfuric acid should be added to the reaction mixture. Afterwards, the reaction mixture should be extracted with several volumes of methylene chloride. These combined volumes can then be carefully distilled to recover the nitric acid of 99% purity (see nitric acid, 90% and 99% respectively).

Add 700 milliliters of 99% nitric acid to a flask, and then gently heat the acid to 60 Celsius. When the acid reaches 60 Celsius, slowly add, drop-wise, 100 milliliters of 99% isopropyl alcohol over a 50-minute period while stirring the nitric acid and keeping its temperature at 60 Celsius. Note: brown fumes of nitrogen oxides will develop. After the addition, raise the temperature of the reaction mixture to 70 Celsius, and hold this temperature for 2 hours with constant stirring. After heating for 2 hours, remove the heat source and allow the reaction mixture to cool to room temperature. After which, extract the reaction mixture with six 150-milliliter portions of methylene chloride. After the extraction process, combine all methylene chloride portions, if not already done so, and then add 100 grams of anhydrous calcium sulfate, and stir the mixture for 10 minutes. Thereafter, filter-off the calcium sulfate, and then place the filtered methylene chloride mixture into a rotary evaporator and evaporate-off the methylene chloride under vacuum until no more methylene chloride is collected in the receiver flask. Note: at first, if any insoluble solids form, briefly stop the evaporation to filter them off. If a rotary evaporator is unavailable, carefully distill-off the methylene chloride at 40 Celsius until no more methylene chloride collects in the receiver flask. When all the methylene chloride has been removed, collect the nitroform crystals (or liquid), and then store in a refrigerator until use.

Notes:

Procedure 21-01B: Preparation of Nitroform

Materials:	1. 150 milliliters methanol
	2. 62 grams sodium nitrite
	3. 76 grams baking soda
	4. 157 grams tetranitromethane
	5. 250 milliliters 35 – 38% hydrochloric acid
	6. 900 milliliters methylene chloride
	7. 100 grams anhydrous calcium sulfate

Summary: Nitroform is conveniently prepared by reacting tetranitromethane with sodium nitrite and baking soda in the presence of methanol. The resulting sodium salt of nitroform remains dissolved in the aqueous methanol, and is then treated with concentrated hydrochloric acid. The resulting free nitroform is then extracted into methylene chloride, and the mixture evaporated. Commercial & Industrial note: Part or parts of this laboratory process may be protected by international, and/or commercial/industrial processes. Before using this process to legally manufacture the mentioned explosive, with intent to sell, consult any protected commercial or industrial processes related to, similar to, or additional to, the process discussed in this procedure. This process may be used to legally prepare the mentioned explosive for laboratory, educational, or research purposes.

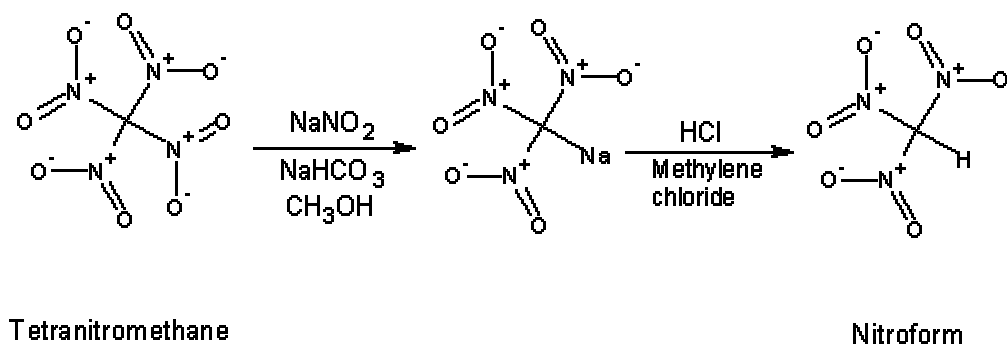
*Reaction Equation*

Hazards: Wear gloves and use proper ventilation when handling concentrated hydrochloric acid. Hydrochloric acid is a highly fuming liquid evolving highly corrosive and irritating vapors. Avoid inhalation of vapors.

Procedure:

Step 1: Preparation of sodium nitroform solution

Prepare a methanol solution by adding 150 milliliters of methanol into 150 milliliters of water. After which, add 62 grams of sodium nitrite, and 76 grams of baking soda and stir the whole mixture rapidly. After adding the nitrite and baking soda, heat the mixture to 50 Celsius with rapid stirring. When the temperature of the reaction mixture reaches about 50 Celsius, add drop wise, 157 grams of tetranitromethane over a period of 20 minutes with rapidly stirring and keeping the reaction mixtures temperature at 50 Celsius. The initial colorless liquid will then turn yellow, and then red. After the addition of the tetranitromethane, continue heating at 50 Celsius with rapid stirring for 3 hours. After 3 hours, remove the heat source and allow the reaction mixture to cool to room temperature. Thereafter, filter-off any insoluble materials, and then save the filtered-off reaction mixture for step 2.

Step 2: Preparation of Nitroform

To the reaction mixture containing sodium nitroform (prepared in step 1), add 250 milliliters of 35 – 38% hydrochloric acid over a period of 10 or 20 minutes while rapidly stirring the sodium nitroform mixture. Then, extract the mixture with six 150-milliliter portions of methylene chloride. After the extraction, combine all methylene chloride fractions, if not already done so, and then add 100 grams of anhydrous calcium sulfate. After the addition of the calcium sulfate, stir the mixture for ten minutes, after which, filter-off the calcium sulfate. Then, place the filtered methylene chloride mixture into a rotary evaporator, and evaporate-off the methylene chloride under vacuum until no more methylene chloride is collected in the receiver flask. Note: at first, during the evaporation process, if any insoluble solids form, stop the evaporation briefly to filter-off the solids. If a rotary evaporator is unavailable, carefully distill-off the methylene chloride until no more methylene chloride is collected in the receiver flask. When all the methylene chloride has been removed, collect the nitroform crystals (or liquid), and store in a refrigerator until use. The result will be about 22 grams of liquid nitroform.

Notes:

Procedure 21-01C: Preparation of Nitroform

Materials:	1. 500 milliliters methanol
	2. 188 grams potassium nitrite
	3. 152 grams potassium carbonate
	4. 392 grams tetranitromethane
	5. 100 grams anhydrous hydrogen chloride
	6. 2000 milliliters methylene chloride
	7. 200 milliliters of diethyl ether

CHAPTER 21: THE PREPARATION OF NITRO PARAFFINS AND THEIR DERIVATIVES

Summary: Nitroform can be prepared from its potassium salt by treatment with anhydrous hydrogen chloride. The potassium nitroform is prepared by treating tetranitromethane with potassium nitrite and potassium carbonate in the presence of methanol. The potassium salt, being less soluble than the sodium salt, precipitates from the reaction mixture. It is then collected by filtration, washed, and then dried to yield an impure mass containing roughly 80% potassium nitroform. For the preparation of nitroform in the next step, this crude potassium nitroform need not be purified. Commercial & Industrial note: Part or parts of this laboratory process may be protected by international, and/or commercial/industrial processes. Before using this process to legally manufacture the mentioned explosive, with intent to sell, consult any protected commercial or industrial processes related to, similar to, or additional to, the process discussed in this procedure. This process may be used to legally prepare the mentioned explosive for laboratory, educational, or research purposes.

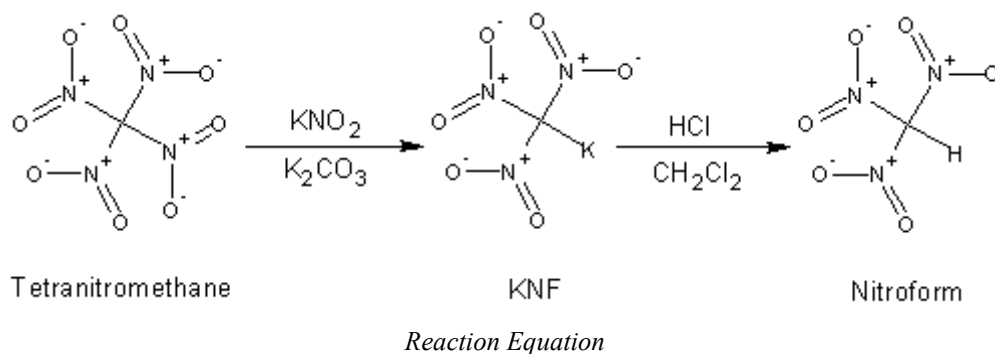

Hazards: Use proper ventilation when handling anhydrous hydrogen chloride, and avoid inhalation of vapors. Anhydrous hydrogen chloride is very corrosive.

Procedure:

Step 1: Preparation of potassium nitroform

Prepare a methanol solution by adding 300 milliliters of methanol into 300 milliliters of water. Thereafter, add and dissolve 152 grams of potassium carbonate and then 188 grams of potassium nitrite while rapidly stirring the methanol solution. After which, heat the mixture to 50 Celsius, and then add drop wise, 392 grams of tetranitromethane over a period of 40 minutes while rapidly stirring the reaction mixture, and maintaining its temperature at 50 Celsius. After the addition, continue to stir the reaction mixture at 50 Celsius for about 3 hours. After heating for 3 hours, remove the heat source, and allow the reaction mixture to cool to room temperature. Shortly thereafter, place the reaction mixture into an ice bath, and chill to 0 Celsius for about 20 minutes. After which, filter-off the precipitated product, wash with 200 milliliters of cold methanol, and then with 200 milliliters of cold diethyl ether. After which, vacuum dry or air-dry the product. The result will be about 460 grams of crude potassium nitroform containing exactly 304 grams potassium nitroform, and 156 grams of impurities. Save this crude product for step 2.

Step 2: Preparation of Nitroform

Place 400 grams of the crude potassium nitroform prepared in step 1 into 2000 milliliters of methylene chloride. Then, chill this suspension to about 10 Celsius using an ice water bath, and then begin rapidly stirring the mixture. After which, pass dry hydrogen chloride gas into the methylene chloride suspension with rapid stirring until the color of the suspended solids change from yellow to white (60 to 100 grams of anhydrous hydrogen chloride). When the color changes from yellow to white, stop passing anhydrous hydrogen chloride into the methylene chloride mixture, and then filter-off the precipitated by-products. Thereafter, place the methylene chloride mixture into a rotary evaporator, and then evaporate-off the methylene chloride under vacuum until no more methylene chloride collects in the receiver flask. Note: At first, if any insoluble solids form during the evaporation process, briefly stop the evaporation, and filter them off. If a rotary evaporator is not available, carefully distill-off the methylene chloride until no more passes into the receiver flask. When no more methylene chloride is evaporated-off, remove the nitroform crystals (or liquid), and store in a refrigerator until use.

Notes:

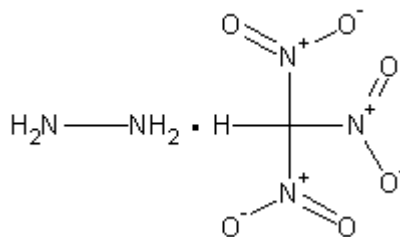
21-02. HNF. *Hydrazine nitroform; Hydrazinium nitroformate*

Hydrazine nitroform

Hydrazine nitroform forms yellow crystals. The crystals are remarkably stable—even when heated to 70 Celsius. However, they begin to decompose when heated to 110 Celsius and the crystals may ignite violently above 110 Celsius. Hydrazine nitroform is relatively resistant to shock, friction, and percussion, and as a result, it is used extensively in the production of high performance rocket propellants, and gun propellants.

Molecular weight: 183.08	Flammability: May deflagrate on ignition
Detonating velocity: Uncalculated	Toxicity: Low
Sensitivity: Moderate	Classification: Secondary explosive
Stability: Moderate	Overall value (as secondary explosive): Moderate

Procedure 21-02A: Preparation of Hydrazine nitroform

Materials:	1. 31 grams nitroform
	2. 2200 milliliters of diethyl ether
	3. 6.4 grams anhydrous hydrazine

Summary: Hydrazine nitroform can be made by simply neutralizing nitroform with hydrazine in the presence of diethyl ether. The hydrazine nitroform is then collected by evaporation of the ether. Commercial & Industrial note: For related, or similar information, see Serial No. 47,322, April 16th, 1968, by Esso Research and Engineering Company, to John R. Lovett, Edison, NJ. Part or parts of this laboratory process may be protected by international, and/or commercial/industrial processes. Before using this process to legally manufacture the mentioned explosive, with intent to sell, consult any protected commercial or industrial processes related to, similar to, or additional to, the process discussed in this procedure. This process may be used to legally prepare the mentioned explosive for laboratory, educational, or research purposes.

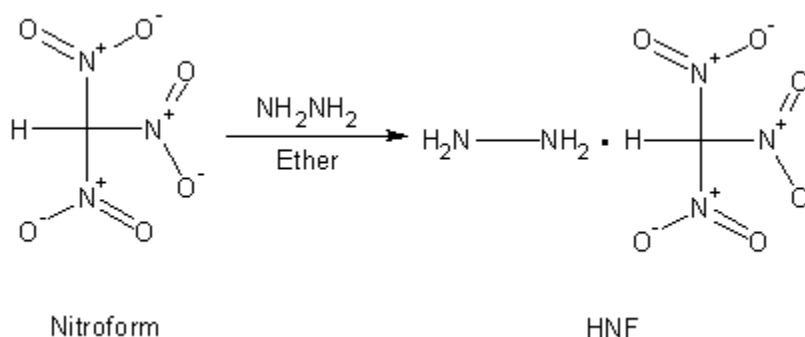
*Reaction Equation*

Hazards: Ether is highly flammable, and easily forms explosive peroxides when exposed to air. Make sure the ether is free of peroxides before using; perform the peroxide test. Hydrazine may be a carcinogen so handle with care.

Procedure: Prepare a solution by dissolving 31 grams of nitroform into 2000 milliliters of diethyl ether. Then prepare a suspension of hydrazine in ether by adding 6.4 grams of anhydrous hydrazine into 200 milliliters of diethyl ether. Then place this hydrazine ether suspension into an ice bath. Afterwards, slowly add, drop-wise, the nitroform solution to the hydrazine ether suspension while rapidly stirring the hydrazine ether suspension and maintaining its temperature around 0 Celsius. After

CHAPTER 21: THE PREPARATION OF NITRO PARAFFINS AND THEIR DERIVATIVES

the addition, stir the reaction mixture at 0 Celsius for about 30 minutes. Then place the mixture into a rotary evaporator, and evaporate-off the ether. The result will be high purity hydrazine nitroform in the form of a yellow crystalline solid. Note: If a rotary evaporator is unavailable, the ether can be evaporated by careful distillation.

Notes:

Procedure 21-02B: Preparation of Hydrazine nitroform

Materials:	1. 110 grams nitroform
	2. 1200 milliliters methanol
	3. 20 grams anhydrous hydrazine
	4. 2100 milliliters carbon tetrachloride

Summary: Hydrazine nitroform can be prepared by reacting anhydrous hydrazine with nitroform in the presence of methanol. The reaction mixture is then treated with a large excess of carbon tetrachloride; the hydrazine nitroform then precipitates out. The product can then be collected by filtration, washed, and then dried. Commercial & Industrial note: Part or parts of this laboratory process may be protected by international, and/or commercial/industrial processes. Before using this process to legally manufacture the mentioned explosive, with intent to sell, consult any protected commercial or industrial processes related to, similar to, or additional to, the process discussed in this procedure. This process may be used to legally prepare the mentioned explosive for laboratory, educational, or research purposes.

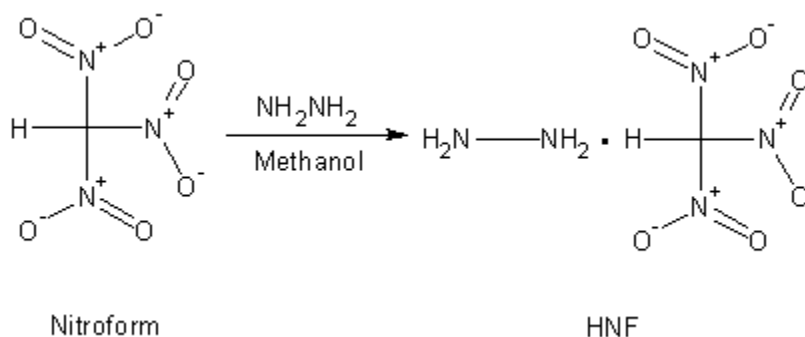

Reaction Equation

Hazards: Carbon tetrachloride should be handled with care. Avoid breathing vapors, and wear gloves when handling. Carbon tetrachloride may be a carcinogen. Hydrazine may be a carcinogen so handle with care.

Procedure: Prepare a solution by adding 20 grams of anhydrous hydrazine into 200 milliliters of methanol. Prepare a second solution by adding 110 grams of nitroform into 1000 milliliters of methanol. Then add the hydrazine solution to the nitroform solution over a period of about 5 minutes. Afterwards, stir the reaction mixture for ten minutes. Then place 2000 milliliters of carbon tetrachloride into a suitable beaker, and then add the reaction mixture all at once while rapidly stirring the carbon tetrachloride. After which, filter-off the yellow precipitate, wash with 250 milliliters of carbon tetrachloride (several times using the same washing portion), and then vacuum dry or air-dry the product. The result will be high purity hydrazine nitroform in the form of a yellow crystalline solid.

Notes:

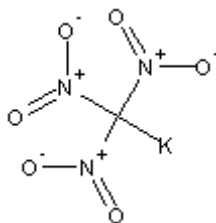
21-03. KNF. *Potassium nitroform*

KNF

KNF forms colorless to white crystals or powder. The crystals are stable, and are widely used in gunpowders, rocket propellants, and fireworks. Although the crystals are relatively stable, they ignite and burn violently and rapidly. Even though KNF is easily ignited, it doesn't detonate unless initiated by a primary explosive.

Molecular weight: 189.126	Flammability: Highly flammable (deflagrates)
Detonating velocity: Uncalculated	Toxicity: Moderate
Sensitivity: Moderate	Classification: Secondary explosive
Stability: Moderate	Overall value (as secondary explosive): High

Procedure 21-03A: Preparation of KNF

Materials:	1. 66 milliliters of 99% dioxane
	2. 17 grams potassium nitrite
	3. 20 grams potassium bicarbonate
	4. 16 grams tetranitromethane

Summary: Potassium nitroform can easily be prepared by reacting tetranitromethane with potassium nitrite and potassium bicarbonate in the presence of a dioxane/water solution. The resulting mixture is then heated, and then cooled in an ice water bath. The resulting precipitated product is then filtered-off, and then dried. Commercial & Industrial note: For related, or similar information, see Serial No. 786,437, January 12th, 1959, by The United States Navy, to Donald J. Glover, Bowie Md; Joseph C. Dacons, and Darrell V. Sickman, both of Washington DC, and Marios E. Hill Kensington, and Mortimer J. Kamlet, both of Silver Spring Md. Part or parts of this laboratory process may be protected by international, and/or commercial/industrial processes. Before using this process to legally manufacture the mentioned explosive, with intent to sell, consult any protected commercial or industrial processes related to, similar to, or additional to, the process discussed in this procedure. This process may be used to legally prepare the mentioned explosive for laboratory, educational, or research purposes.

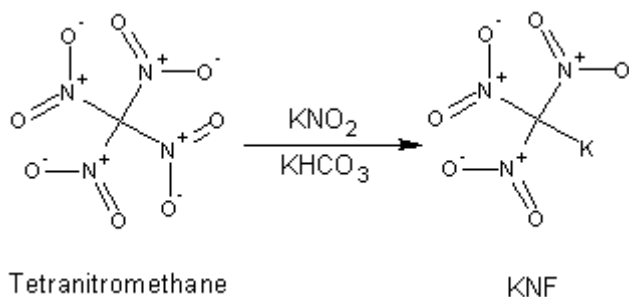
*Reaction Equation*

Hazards: Use proper ventilation when handling dioxane. Dioxane is a suspected carcinogen, so avoid inhalation of vapors.

Procedure: Prepare a dioxane solution by dissolving 66 milliliters of 99% dioxane into 134 milliliters of water. Thereafter, add and dissolve 20 grams of potassium nitrite, and then 20 grams of potassium bicarbonate while rapidly stir the dioxane/water solution. After the addition, add 16 grams tetranitromethane with rapid stirring of the reaction mixture. After the addition, heat the mixture to 45 Celsius with stirring, for 3 hours. During the heating process, normal color changes will occur, and the

CHAPTER 21: THE PREPARATION OF NITRO PARAFFINS AND THEIR DERIVATIVES

potassium salt will begin to precipitate. After the heating process, remove the heat source, and allow the reaction mixture to cool to room temperature. Then, place the reaction mixture into an ice water bath for 30 to 50 minutes. After which time, filter-off the potassium salt, and then vacuum dry or air-dry the product. The result will be about 12 grams of relatively pure potassium nitroform.

Notes:

21-04. Silver nitroform

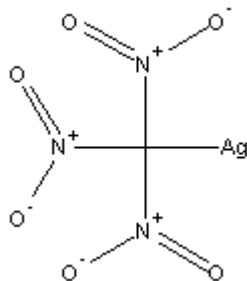

Silver nitroform

Silver nitroform forms unstable colorless to white, to light tan crystals, which are unstable to light—the compound darkens on exposure to light and should be stored in amber glass bottles in a refrigerator. Silver nitroform is used as a primary explosive in priming compositions for bullets, initiating compositions for blasting caps and detonators, and as a substitute for lead azide, lead styphnate, and mercury fulminate. The salt should be handled with care, and may detonate by percussion, heat, sparks, or flame.

Molecular weight: 257.89	Flammability: Detonates when ignited
Detonating velocity: Uncalculated	Toxicity: Low
Sensitivity: High	Classification: Primary explosive
Stability: Moderate	Overall value (as primary explosive): High

Procedure 21-04A: Preparation of Silver nitroform

Materials:	1. 24 grams nitroform
	2. 500 milliliters ethyl ether
	3. 30 grams silver-I-oxide

Summary: Silver nitroform is easily obtained by reacting silver-I-oxide with a solution of nitroform in ether. The resulting mixture is then filtered, and evaporated until dry solid remains. Commercial & Industrial note: Part or parts of this laboratory process may be protected by international, and/or commercial/industrial processes. Before using this process to legally manufacture the mentioned explosive, with intent to sell, consult any protected commercial or industrial processes related to, similar to, or additional to, the process discussed in this procedure. This process may be used to legally prepare the mentioned explosive for laboratory, educational, or research purposes.

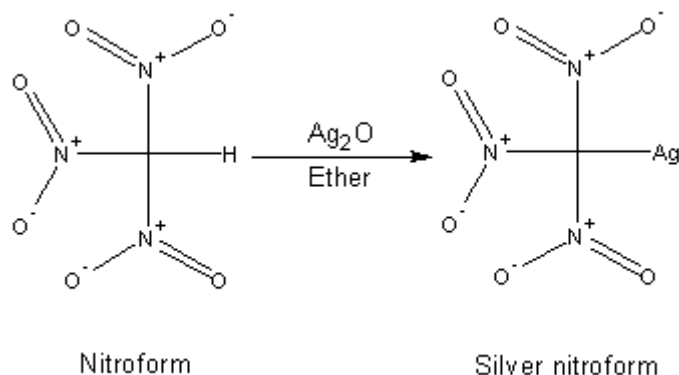
*Reaction Equation*

Hazards: Use maximum ventilation when handling ether, and avoid inhalation of vapors. Perform the peroxide test before using ether.

Procedure: Add and dissolve 24 grams of nitroform into 500 milliliters of diethyl ether contained in a suitable flask. Thereafter, place 30 grams of silver-I-oxide into a beaker, and then add about 20 milliliters of water and then stir the suspension for 10 minutes. Then, filter-off the silver oxide, and then add it rapidly while it's still moist, to the nitroform solution while rapidly stirring the nitroform solution. After the addition, cap the flask and the shake the contents vigorously for 10 minutes. After shaking for 10 minutes, filter-off the unreacted silver oxide, and then place the filtered mixture into a rotary evaporator, and evaporate the mixture under high vacuum until dry silver nitroform remains. Note: water will be present in the filtered mixture, so high vacuum should be applied to remove it along with the ether. If a rotary evaporator is unavailable, place the mixture into a distillation apparatus and carefully distill-off the diethyl ether until no more ether passes into the receiver flask. Then, cool the remaining residue to room temperature, and then place into a shallow pan and then blow air over the surface to remove the water. Once dry silver nitroform is obtained, remove it and place it into a suitable amber glass bottle. These bottles should be stored in a refrigerator while contained in a desiccator of any type.

Notes:

21-05. TNM. *Tetranitromethane*

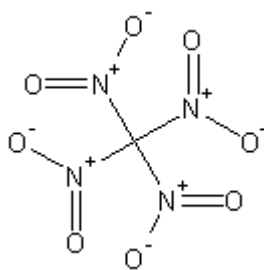

Tetranitromethane

Tetranitromethane is a pale yellow liquid with a melting point of 13.8 Celsius, and a boiling point of 126 Celsius. Note: Tetranitromethane should be distilled under reduced pressure (vacuum distilled) as distilling at atmospheric temperature may result in rapid decomposition. Tetranitromethane is insoluble in water, but freely soluble in alcohol, and ether. It attacks iron, copper, brass, zinc, and rubber forming explosive salts. Keep tetranitromethane stored in amber glass bottles in a refrigerator until use. When tetranitromethane is mixed with oils, waxes, paraffins, starch, glue, grease, wood pulp, or other organic matter, it becomes sensitized and very explosive—these sensitized mixtures are easily detonated by mild shocks (can be detonated by a simple firecracker, but usually requires a primary explosive). Tetranitromethane should not be mixed with strong reducing agents such as hydrides, powdered metals, sulfites, phosphites, or phosphides—as violent reactions may result producing explosive compounds. Note: Never mix metallic lithium, sodium, or potassium with tetranitromethane as detonation may

CHAPTER 21: THE PREPARATION OF NITRO PARAFFINS AND THEIR DERIVATIVES

result. Tetranitromethane is used widely in explosives compositions when mixed with nitrocellulose, nitro starch, or TNT, and it can be used with nitroglycerine in dynamites when mixed with propylene glycol or other glycols (to lower freezing point). Tetranitromethane is also widely used in the preparation of nitroform and its salts, in the preparation of other high explosives, in liquid rocket propellants, fuel additive for model aircraft and racecars, and in plastic and flexible sheet explosives when mixed with RDX or HMX and a high-energy plasticizer. A common liquid explosive composition can be made by mixing tetranitromethane 75% with toluene 25%—this composition requires a blasting cap or detonator for initiation.

Molecular weight: 127.992	Flammability: May burn on ignition
Detonating velocity: Uncalculated	Toxicity: Low
Sensitivity: Moderate	Classification: Secondary explosive
Stability: Moderate	Overall value (as secondary explosive): Very High

Procedure 21-05A: Preparation of TNM

Materials:	1. 240 milliliters of 90% nitric acid
	2. 180 milliliters 20% fuming sulfuric acid
	3. 61 grams of malonamide
	4. 180 milliliters of 98% sulfuric acid

Summary: TNM can be prepared by reacting malonamide with fuming nitric acid in the presence of fuming sulfuric acid and concentrated sulfuric acid. Fuming sulfuric acid is used to remove any water that may form, or be present. Commercial & Industrial note: For related, or similar information, see Serial No. 592,468, December 4th, 1962, by The United States Navy, to Howard G. Clark, Decatur Alabama, Charles W. Plummer, Rockland Mass., and Sandor A. Hoffmann, Bayonne, NJ. Part or parts of this laboratory process may be protected by international, and/or commercial/industrial processes. Before using this process to legally manufacture the mentioned explosive, with intent to sell, consult any protected commercial or industrial processes related to, similar to, or additional to, the process discussed in this procedure. This process may be used to legally prepare the mentioned explosive for laboratory, educational, or research purposes.

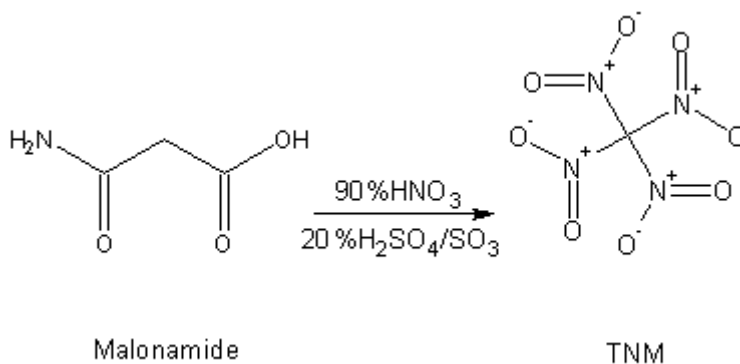

Reaction Equation

Hazards: Wear gloves and use proper ventilation when handling 90% nitric acid, and 20% sulfuric acid; both evolve very toxic fumes. 20% fuming sulfuric acid will eat through most clothing, causing a “melting” effect of the cloths fibers to the skin; a series of operations will be needed to remove the fibers from the skin. TNM can cause headaches, dizziness, and soar throat if inhaled. These headaches may persist for quite some time. TNM may cause skin burns, so wear gloves when handling.

Procedure: Note: This procedure uses an excessive amount of 90% nitric acid to properly carryout the reaction. This excessive amount of acid can be recovered by treating the reaction mixture (after complete removal of the product) with methylene chloride to recover the nitric acid. Prior to this action, a small amount of sulfuric acid should be added to the reaction mixture. Afterwards, the reaction mixture should be extracted with several volumes of methylene chloride. These combined volumes can then be carefully distilled to recover the nitric acid of 99% purity (see nitric acid, 90% and 99% respectively).

Prepare a nitrating acid mixture by adding 240 milliliters of 90% nitric into a suitable flask, and then cool this flask in an ice bath. Shortly after, carefully add 180 milliliters of 20% fuming sulfuric acid (keep the acid mixture below 5 Celsius). Afterwards, prepare a malonamide mixture by dissolving 61 grams malonamide into 120 milliliters of 98% sulfuric acid. Then remove the nitrating acid mixture form the ice bath, and allow it to warm to room temperature. When this achieved, slowly add the malonamide acid mixture over a period of 90 minutes while stirring the nitrating acid mixture and maintain its temperature below 65 Celsius. Note: during the addition, a vigorous evolution of gas will result. After the addition of the malonamide acid

CHAPTER 21: THE PREPARATION OF NITRO PARAFFINS AND THEIR DERIVATIVES

mixture, stir the reaction mixture for about 60 minutes. After which, heat the mixture at 60 Celsius for 5 hours. Note: after heating for about an hour, a second liquid phase will appear, and this phase will get larger as the formation of tetranitromethane increases. After heating for 5 hours, remove the heat source and allow the reaction mixture to cool to room temperature. Afterwards, place the reaction mixture into a cold-water bath for 10 minutes. After which, pour the entire reaction mixture into 1200 milliliters of ice water, and then remove the upper tetranitromethane layer either by simply decanting it, or using a separatory funnel. Thereafter, wash the liquid nitro product with six 35-milliliter portions of water (note: the TNM will be the bottom layer each time, as long as sulfuric acid is not present), and then with two 30-milliliter portions of 98% sulfuric acid (note: the TNM will be the upper layer this time; sulfuric acid is more dense than TNM). The result will be about 50 grams of relatively pure tetranitromethane as a pale yellow liquid. Note: Store tetranitromethane in amber glass bottles in a refrigerator.

Notes:

Procedure 21-05B: Preparation of TNM

Materials:	1. 200 milliliters of 90% nitric acid
	2. 200 milliliters 20% fuming sulfuric acid
	3. 42 grams of cyanoacetic acid
	4. 110 milliliters of 98% sulfuric acid

Summary: Tetranitromethane is prepared first by reacting cyanoacetic acid with water and sulfuric acid to form malonamide (not shown in the reaction equation). Then this malonamide acid mixture is then treated with 90% nitric acid, and 20% fuming sulfuric acid to yield the TNM. The TNM is then removed by decantation, and then washed. Commercial & Industrial note: For related, or similar information, see Serial No. 592,468, December 4th, 1962, by The United States Navy, to Howard G. Clark, Decatur Alabama, Charles W. Plummer, Rockland Mass., and Sandor A. Hoffmann, Bayonne, NJ. Part or parts of this laboratory process may be protected by international, and/or commercial/industrial processes. Before using this process to legally manufacture the mentioned explosive, with intent to sell, consult any protected commercial or industrial processes related to, similar to, or additional to, the process discussed in this procedure. This process may be used to legally prepare the mentioned explosive for laboratory, educational, or research purposes.

Hazards: Wear gloves and use proper ventilation when handling 90% nitric acid, and 20% sulfuric acid; both evolve very toxic fumes. 20% fuming sulfuric acid will eat through most clothing, causing a “melting” effect of the cloth fibers to the skin; a series of operations will be needed to remove the fibers from the skin. TNM can cause headaches, dizziness, and soar throat if inhaled. These headaches may persist for quite some time. TNM may cause skin burns, so wear gloves when handling.

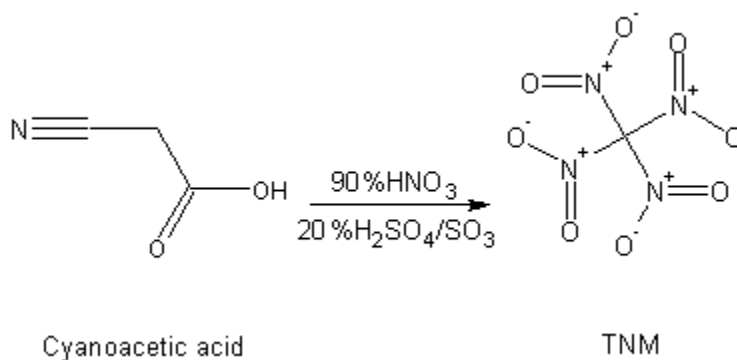

Reaction Equation

Procedure: Note: This procedure uses an excessive amount of 90% nitric acid to properly carry out the reaction. This excessive amount of acid can be recovered by treating the reaction mixture (after complete removal of the product) with methylene chloride to recover the nitric acid. Prior to this action, a small amount of sulfuric acid should be added to the reaction mixture. Afterwards, the reaction mixture should be extracted with several volumes of methylene chloride. These combined volumes can then be carefully distilled to recover the nitric acid of 99% purity (see nitric acid, 90% and 99% respectively).

CHAPTER 21: THE PREPARATION OF NITRO PARAFFINS AND THEIR DERIVATIVES

Add 100 milliliters of 98% sulfuric acid into a suitable flask, and then add 10 milliliters of water. Afterwards, cool the acid mixture with a cold water bath. Then gradually add 42 grams of cyanoacetic acid while stirring the acid mixture and maintain its temperature below 20 Celsius. After the addition, allow the mixture to warm to room temperature while letting it sit for about 2 hours. Note: there will be some gas evolution during this time. Afterwards, prepare a nitrating acid mixture by carefully adding 200 milliliters of 20% fuming sulfuric acid into 200 milliliters of 90% nitric acid (the 90% nitric acid should first be put into a cold water bath before adding the sulfuric acid). Then, heat this nitrating acid mixture to about 50 Celsius; do not allow the temperature to rise above 55 Celsius. When the nitrating acid mixture reaches 50 Celsius, slowly add, drop-wise, the cyanoacetic acid mixture while stirring the nitrating acid and maintaining its temperature below 55 Celsius. After the addition of the cyanoacetic acid mixture, raise the temperature of the reaction mixture to 90 Celsius, and heat for 3 hours with constant stirring. After this heating period, remove the heat source and allow the reaction mixture to cool to room temperature. Then place the reaction mixture into a cold-water bath for 10 minutes. Then add the entire reaction mixture to 1000 milliliters of ice water. Note: the water layer will turn a bright blue color. Afterwards, decant the upper tetranitromethane layer, wash with six 20-milliliter portions of water (note: the TNM will be the bottom layer each time, as long as sulfuric acid is not present), and then with two 5-milliliter portions of 98% sulfuric acid (note: the TNM will be the upper layer this time; sulfuric acid is more dense than TNM). The result will be 30 grams of liquid nitro product as a pale yellow liquid.

Notes:

Procedure 21-05C: Preparation of TNM

Materials:	1. 27 grams of sulfuryl chloride
	2. 2000 grams of acetic anhydride
	3. 1360 grams of 99% nitric acid
	4. 1000 milliliters 10% baking soda solution
	5. 500 grams anhydrous sodium sulfate

Summary: TNM can be prepared by a modified process using acetic anhydride as the starting compound rather than the normal compounds. In the nitration of acetic anhydride, sulfuryl chloride is used as a catalyst. The reaction is quite slow, and may take up to 6 days depending on the temperature of the reaction mixture. In this procedure the temperature utilized is about 30 Celsius. In this case the reaction takes only 48 hours. The temperature of the reaction should never rise above 40 Celsius. The TNM is then recovered by pouring the entire mixture into water, separating the TNM layer, washing, and drying. Commercial & Industrial note: For related, or similar information, see Serial No. 61,315, January 29th, 1936, by Trojan Powder Company, to Joseph A. Wyler, Allentown, PA. Part or parts of this laboratory process may be protected by international, and/or commercial/industrial processes. Before using this process to legally manufacture the mentioned explosive, with intent to sell, consult any protected commercial or industrial processes related to, similar to, or additional to, the process discussed in this procedure. This process may be used to legally prepare the mentioned explosive for laboratory, educational, or research purposes.

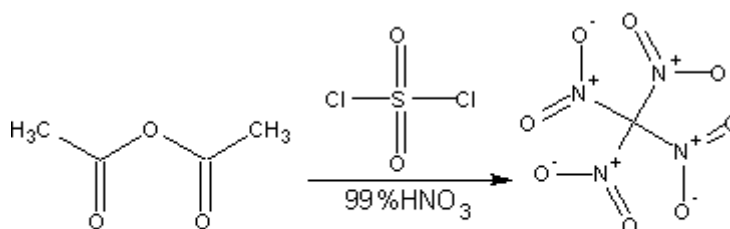

Acetic anhydride

TNM

Reaction Equation

Hazards: Wear gloves and use proper ventilation when handling sulfuryl chloride and avoid inhalation of the vapors. Wear gloves and use proper ventilation when handling 99% nitric acid. Avoid inhalation of the poisonous fumes.

Procedure: Dissolve 27 grams of sulfuryl chloride into 2000 grams of acetic anhydride. Then add 1360 grams of 99% nitric acid into a flask, and then cool to 10 Celsius by an ice water bath. Thereafter, slowly add drop wise, the acetic anhydride mixture to the 99% nitric acid over a sufficient period as to keep the temperature of the 99% nitric acid below 20 Celsius. During the addition, rapidly stir the nitric acid. After the addition, remove the ice water bath, and then place the reaction mixture into a hot water bath, and then stir the reaction for 48 hours at about 30 Celsius. After 48 hours, pour the entire reaction mixture into 1500 milliliters of cold water while stirring the water. Thereafter, remove the upper tetranitromethane layer, and then wash with six 100-milliliter portions of cold water, and then with 200 milliliters of 10% baking soda solution. Note: After each washing, the tetranitromethane will be the bottom layer, as long as sulfuric acid is not present. After washing, dry over 100 grams of anhydrous sodium sulfate while stirring. Then, filter-off the sodium sulfate, and place the filtered TNM into a suitable amber glass bottle for storage until use.

Notes:

21-06. TBA. 4,4,4-Trinitrobutyraldehyde

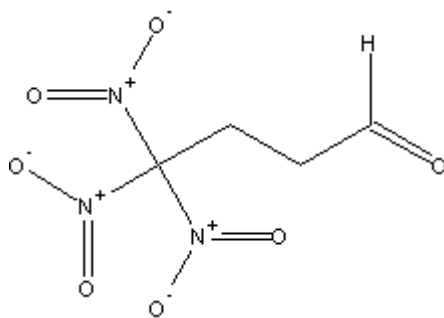

TBA

TBA is a clear or light yellowish, oily liquid with outstanding properties—it is relatively stable to shock, friction, and percussion. TBA is a high-energy plasticizer used in explosives compositions and composites of the plastic explosive, and flexible sheet explosive type. TBA is also as a high-energy plasticizer for gun propellants and rocket propellants especially with nitrocellulose, and nitro starch. TBA is used as a substitute or preferred high energy plasticizer to more common, yet older high energy plasticizers of bis(2,2-dinitropropyl)formal, and bis(2,2,2-fluoridinitroethyl)formal—both of which are well known high energy plasticizers used in explosive compositions. TBA can also be used as a high-energy filler for nitroglycerine or nitroglycerine substitutes in dynamites.

Molecular weight: 195.087	Flammability: Generally non flammable but may burn on ignition
Detonating velocity: Uncalculated	Toxicity: Low
Sensitivity: Moderate	Classification: Secondary explosive
Stability: Moderate	Overall value (as secondary explosive): High

Procedure 21-06A: Preparation of TBA

Materials:	1. 281 grams of nitroform
	2. 110 grams acrolein
	3. 800 milliliters methylene chloride
	4. 100 grams anhydrous magnesium sulfate

Summary: TBA is obtained by treating nitroform with acrolein in the presence of excess water. The reaction is very simple, and the desired product is later recovered after the upper water layer is removed. This upper water layer is then extracted with methylene; then all organic layers are combined, and evaporated to yield an oil. This oil is then purified by passing through a silica gel column along with methylene chloride. Commercial & Industrial note: For related, or similar information, see Application No. 082,879, February 13th, 1990, by The United states Air Force, to Milton B. Frankel, Tarzana, CA, and James

CHAPTER 21: THE PREPARATION OF NITRO PARAFFINS AND THEIR DERIVATIVES

F. Weber, Moorpark, CA. Part or parts of this laboratory process may be protected by international, and/or commercial/industrial processes. Before using this process to legally manufacture the mentioned explosive, with intent to sell, consult any protected commercial or industrial processes related to, similar to, or additional to, the process discussed in this procedure. This process may be used to legally prepare the mentioned explosive for laboratory, educational, or research purposes.

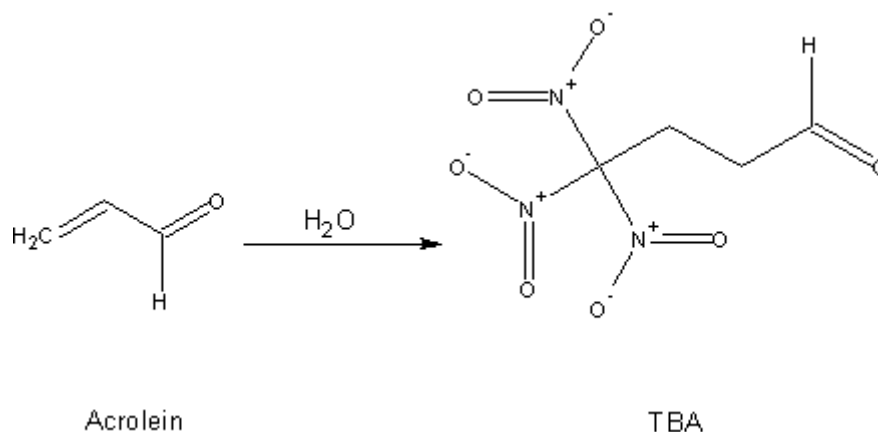

Reaction Equation

Hazards: Use proper ventilation when handling acrolein. Acrolein is a flammable liquid with a pungent odor. Avoid inhalation of vapors.

Procedure: Prepare a solution by dissolving 281 grams of nitroform into 2270 milliliters of water (11% solution). Then place this solution into an ice bath and cool to 0 Celsius. Then dissolve 110 grams of acrolein into 800 milliliters of water. Afterwards, when the nitroform solution is at 0 Celsius, slowly add the acrolein solution at a rate sufficient to keep the nitroform solution at a temperature around 0 Celsius (a dry ice bath may work better) while stirring the nitroform solution. After the addition, remove the ice bath, and stir the reaction mixture at room temperature overnight; during which time two phases will separate. The next day, remove the upper water layer by decantation, and then extract this water layer with four 200-milliliter portions of methylene chloride. Then combine all methylene chloride fractions (if not already done so), and then add the bottom layer of the reaction mixture to the combined methylene chloride extracts. After which, wash this methylene chloride mixture with two 200-milliliter portions of cold water, and then after decanting both upper cold water washing portions, add 100 grams of anhydrous magnesium sulfate (to absorb water). Then, filter-off the magnesium sulfate, and then evaporate the mixture using a rotary evaporator; if one is not available, carefully distilling-off the methylene chloride at 40 Celsius can be used. After evaporating the methylene chloride, the result will be 351 grams of TBA as a yellow oil. Purification is accomplished by passing the yellow oil through a glass column filled with silica gel, and before the TBA completely passes through the column, adding four 200-milliliter portions of methylene chloride. Afterwards, the methylene chloride/TBA mixture collected, is then evaporated in a rotary evaporator until a clear, light yellow liquid is obtained; if a rotary evaporator is unavailable, carefully distilling at 40 Celsius to remove the methylene chloride can be used. After which, the result will be a clear, light yellow oil.

Notes:

21-07. TNB. 4,4,4-Trinitro-1-butanol

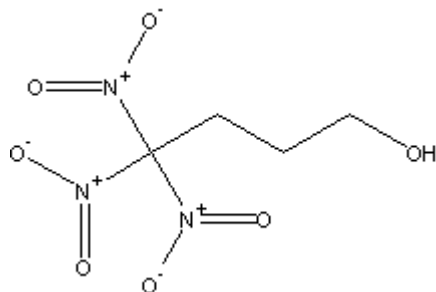

TNB

TNB forms a yellow oil with similar characteristics to TBA. TNB is widely used as a high-energy plasticizer in the same manner as TBA. It has excellent resistance to shock, friction, and percussion, and can be used in a variety of applications—see TBA.

Molecular weight: 209.114	Flammability: Generally non flammable but may burn on ignition
Detonating velocity: Uncalculated	Toxicity: Low
Sensitivity: Moderate	Classification: Secondary explosive
Stability: Moderate	Overall value (as secondary explosive): High

Procedure 21-07A: Preparation of TNB

Materials:	1. 176 grams 4,4,4-trinitrobutyaldehyde
	2. 200 milliliters methanol
	3. 26 grams sodium borohydride
	4. 800 milliliters of 18% hydrochloric acid
	5. 600 milliliters methylene chloride
	6. 400 milliliters 10% baking soda solution
	7. 100 grams anhydrous magnesium sulfate

Summary: TNB is prepared by reducing TBA with sodium borohydride in methanol solution. The resulting mixture is then extracted with methylene chloride, and then evaporated to yield the product as a yellow oil. Commercial & Industrial note: For related, or similar information, see Application No. 082,879, February 13th, 1990, by The United States Air Force, to Milton B. Frankel, Tarzana, CA, and James F. Weber, Moorpark, CA. Part or parts of this laboratory process may be protected by international, and/or commercial/industrial processes. Before using this process to legally manufacture the mentioned explosive, with intent to sell, consult any protected commercial or industrial processes related to, similar to, or additional to, the process discussed in this procedure. This process may be used to legally prepare the mentioned explosive for laboratory, educational, or research purposes.

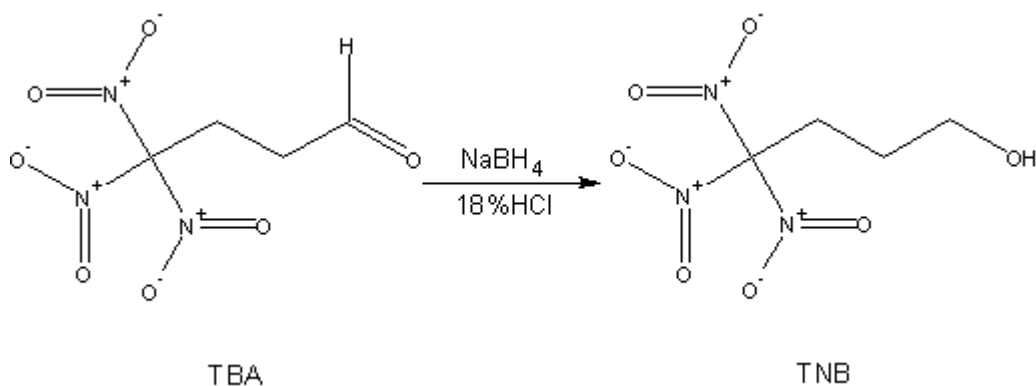

Reaction Equation

Hazards: Wear gloves when handling sodium borohydride, which can cause skin burns.

CHAPTER 21: THE PREPARATION OF NITRO PARAFFINS AND THEIR DERIVATIVES

Procedure: Add and dissolve 176 grams of 4,4,4-trinitrobutylaldehyde into 200 milliliters of methanol, and then cool this mixture to 0 Celsius in an ice bath. Afterwards, gradually add 26 grams of sodium borohydride in small portions while rapidly stirring the methanol mixture and maintaining its temperature below 5 Celsius. After the addition, stir the reaction mixture overnight at room temperature. Then, place the mixture into a rotary evaporator and evaporate-off much of the methanol under vacuum until a thick suspension is obtained. Thereafter, remove the thick suspension, place it into an appropriate beaker, and then add 800 milliliters of an 18% hydrochloric acid solution while rapidly stirring the thick suspension. After which, extract the mixture with six 100-milliliter portions of methylene chloride. After the extraction, combine all methylene chloride fractions, if not already done so, and then wash the combined methylene chloride with 200 milliliters of water, then with four 100 milliliter portions of 10% baking soda solution, and finally with one last portion of 200 milliliters of water. Note: after each washing, the bottom layer will be the methylene chloride. Then, add 100 grams of anhydrous magnesium sulfate, and stir the mixture for 10 minutes. Afterwards, filter-off the magnesium sulfate, and then place the filtered mixture into a rotary evaporator and evaporate-off the methylene chloride under vacuum until no more methylene chloride collects in the receiver flask. If a rotary evaporator is unavailable, place the mixture into a distillation apparatus and carefully distill-off the methylene chloride until no more methylene chloride collects in the receiver flask. Then, remove the yellow oil product, and place into a refrigerator until use. The yield will be about 110 grams.

Notes:

21-08. 4,4-DNB. 4,4-Dintro-1-butanol

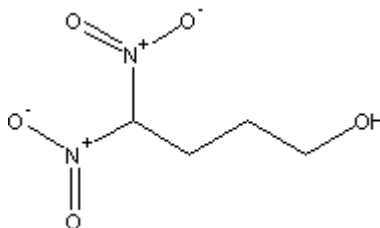

4,4-DNB

4,4-DNB is colorless to yellowish oily liquid with similar to properties to TBA and TNB. It is a high-energy plasticizer with excellent resistance to shock, friction, and percussion, and is even more stable than TBA or TNB. It is widely used in explosives compositions of the plastic explosive and flexible sheet explosive type. 4,4-DNB is widely used in many applications—see TBA.

Molecular weight: 163.109	Flammability: Generally non flammable but may burn on ignition
Detonating velocity: Uncalculated	Toxicity: Low
Sensitivity: Moderate	Classification: Secondary explosive
Stability: Good	Overall value (as secondary explosive): High

Procedure 21-08A: Preparation of 4,4-DNB

Materials:	1. 111 grams of TNB
	2. 1200 milliliters methanol
	3. 285 grams potassium iodide
	4. 50 milliliters 35 – 38% hydrochloric acid
	5. 600 milliliters of 10% sodium bisulfite solution
	6. 600 milliliters methylene chloride
	7. 40 grams anhydrous magnesium sulfate

Summary: 4,4-DNB is prepared by reducing TNB with potassium iodide in the presence of methanol. The reaction is quite slow, taking about 6 days, and after the reaction period, the mixture is acidified with concentrated hydrochloric acid to convert the potassium salt of 4,4-DNB into the free 4,4-DNB. The product is then extracted into methylene chloride, and then evaporated. Commercial & Industrial note: For related, or similar information, see Application No. 082,879, February 13th,

CHAPTER 21: THE PREPARATION OF NITRO PARAFFINS AND THEIR DERIVATIVES

1990, by The United States Air Force, to Milton B. Frankel, Tarzana, CA, and James F. Weber, Moorpark, CA. Part or parts of this laboratory process may be protected by international, and/or commercial/industrial processes. Before using this process to legally manufacture the mentioned explosive, with intent to sell, consult any protected commercial or industrial processes related to, similar to, or additional to, the process discussed in this procedure. This process may be used to legally prepare the mentioned explosive for laboratory, educational, or research purposes.

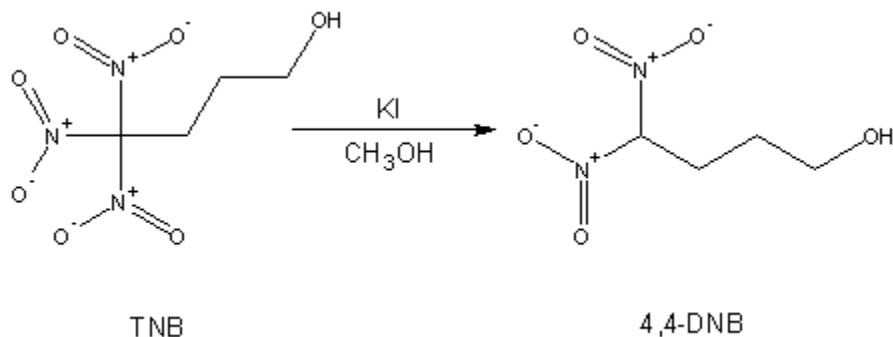

Reaction Equation

Hazards: Wear gloves and use proper ventilation when handling concentrated hydrochloric acid. Avoid inhalation of the vapors. Methanol is toxic, so avoid inhalation and skin absorption.

Procedure: Add and dissolve 111 grams of TNB into 1200 milliliters of methanol. Thereafter, add and dissolve 285 grams of potassium iodide. After which, stir the mixture for 6 days at room temperature. After 6 days, filter-off the potassium salt of 4,4-DNB, and then vacuum dry or air-dry the potassium salt. Thereafter, place 800 milliliters of water, and 50 milliliters of 35 – 38% hydrochloric acid into a beaker, and then add the dry potassium salt while stirring the acid mixture at room temperature. After the addition, stir the reaction for 10 minutes, and then extract the mixture with twelve 50-milliliter portions of methylene chloride. After the extraction, combine all methylene chloride layers, if not already done so, and then wash this combined methylene chloride mixture with six 100-milliliters portions of 10% sodium bisulfite solution. Note: after each washing, the methylene chloride will be the bottom layer. Then, add 40 grams of anhydrous magnesium sulfate to the methylene chloride, and stir the mixture for 10 minutes. Afterwards, filter-off the magnesium sulfate, and then place the methylene chloride mixture into a rotary evaporator, and evaporate-off the methylene chloride under vacuum until no more methylene chloride is collected in the receiver flask. If a rotary evaporator is unavailable, place the mixture into a distillation apparatus, and carefully distill-off the methylene chloride until no more methylene chloride collects in the receiver flask. Thereafter, remove the liquid product, and place into an amber glass bottle into a refrigerator until use. The result will be 44 grams of a yellow oil.

Notes:

21-09. HNH-3. 1,1,1,6,6,6-Hexanitrohexyne-3

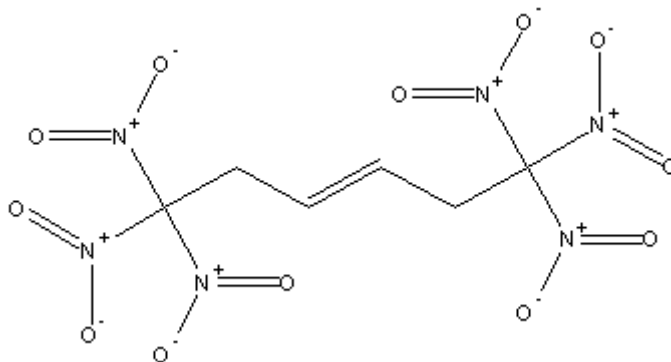

HNH-3

HNH-3 forms white crystals, or pale yellow crystals with a melting point of 130 Celsius. It is sensitive to shock, being detonated by the blow of a hammer or other similar object, but its sensitivity is still far less than to be a concern. HNH-3 is a powerful explosive with good physical properties making it very applicable in explosives compositions when mixed with TNT, RDX, PETN, HMX, or nitrocellulose. The oxygen balance of HNH-3 is very descriptive and allows it to act a strong oxidizer in rocket propellants—HNH-3 is commonly used in high performance gun propellants, rocket propellants, and as a fuel additive for jets and high performance aircraft fuels.

Molecular weight: 354.144	Flammability: Flammable—may deflagrate on ignition
Detonating velocity: Uncalculated	Toxicity: Moderate
Sensitivity: Moderate	Classification: Secondary explosive
Stability: Moderate	Overall value (as secondary explosive): High

Procedure 21-09A: Preparation of HNH-3

Materials:	1. 55 grams nitroform
	2. 625 milliliters of methyl acetate
	3. 75 grams silver-I-oxide
	4. 25 grams 1,4-dibromobutylene-2
	5. 1875 milliliters chloroform

Summary: HNH-3 is prepared by first, reacting nitroform with silver oxide in the presence of methyl acetate. During this reaction, silver nitroform is formed. This silver nitroform is then condensed with 1,4-dibromobutylene-2 forming the desired product. During the addition of the bromocompound, silver bromide is precipitated. After the reaction, the unreacted silver nitroform is filtered-off, and the resulting filtered mixture extracted with chloroform. The bulk of the chloroform is then removed by low heat evaporation, to crystallize the product. Purification is accomplished by recrystallization from chloroform. Commercial & Industrial note: For related, or similar information, see Serial No. 339,481, February 27th 1953, by United States Rubber Company, to Pliny O. Tawney, Passaic NJ. Part or parts of this laboratory process may be protected by international, and/or commercial/industrial processes. Before using this process to legally manufacture the mentioned explosive, with intent to sell, consult any protected commercial or industrial processes related to, similar to, or additional to, the process discussed in this procedure. This process may be used to legally prepare the mentioned explosive for laboratory, educational, or research purposes.

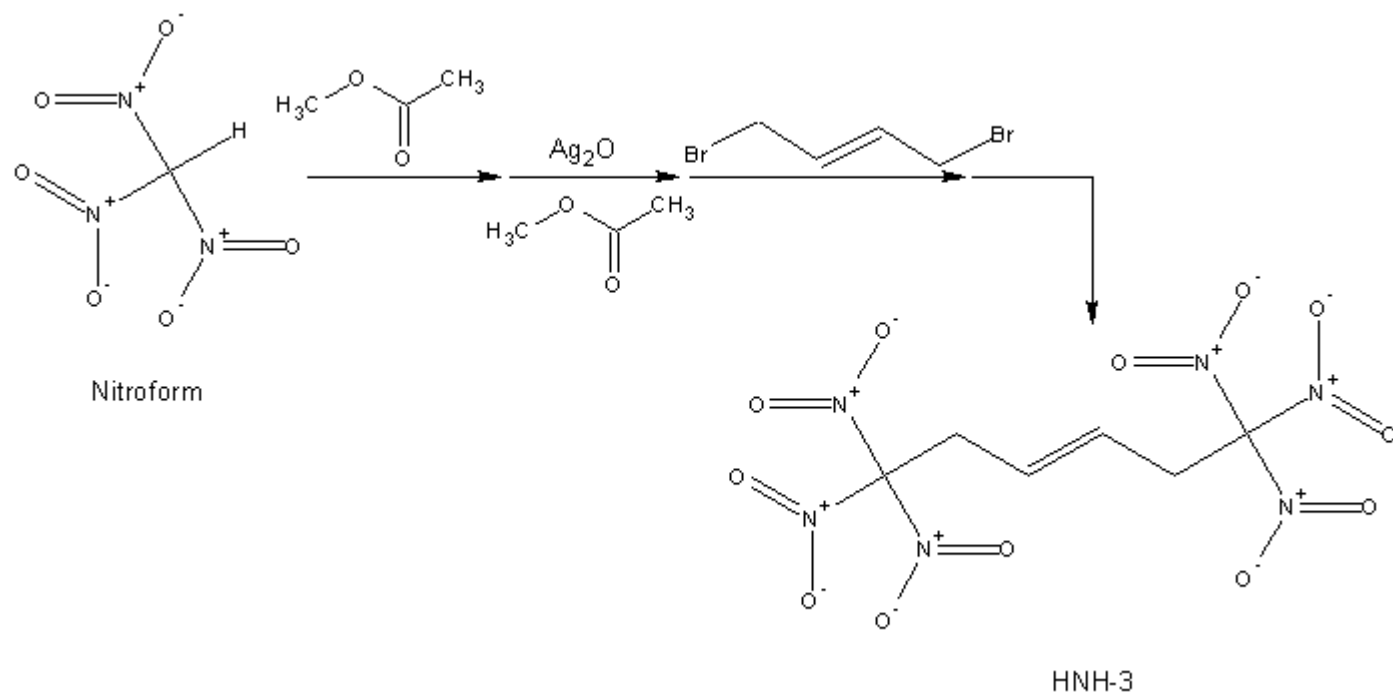

Reaction Equation

Hazards: Use proper ventilation when handling methyl acetate, and chloroform. Avoid inhalation of vapors, and extinguish all flames before using methyl acetate.

Procedure: Prepare a solution by dissolving 55 grams of nitroform into 125 milliliters of methyl acetate. Then prepare a suspension by adding 75 grams of silver oxide into 500 milliliters of methyl acetate, and then place this suspension into an ice bath. Thereafter, gradually add, drop wise, the nitroform solution to the silver oxide suspension over a period sufficient to keep the suspension at 0 Celsius. During the addition, rapidly stir the silver oxide suspension. After the addition, stir the reaction mixture at 0 Celsius for one hour. After stirring for an hour, filter-off the excess silver oxide. Then add 25 grams of 1,4-dibromobuyne-2 to the filtered reaction mixture over a moderately short period of time while rapidly stirring the reaction mixture. During the addition, silver bromide will steadily precipitate. Thereafter, remove the reaction mixture from the ice bath, and allow to warm to room temperature. Then let it stand at room temperature for 2 hours with stirring. After which, remove the precipitated silver bromide by filtration, and then place the mixture into a rotary evaporator and evaporate the reaction mixture until only 2/3 of its volume remains. If a rotary evaporator is unavailable, place the filtered reaction mixture into a distillation apparatus and carefully distill at 56 Celsius until the volume is reduced by 1/3. Thereafter, remove the remaining reaction mixture, and then drown into 1000 milliliters of cold water with stirring. During water treatment, silver nitroform will precipitate. Afterwards, filter-off the silver nitroform, and then extract the filtered water mixture with six 75-milliliter portions of chloroform. Thereafter, combine all extracts, if not already done so, and then place the chloroform mixture into a rotary evaporator, and evaporate the mixture under vacuum until only 10% of its volume remains. Then stop the evaporation process, and then filter-off the precipitated product, and then vacuum dry or air-dry. Shortly afterwards, recrystallize the product from 300 milliliters of chloroform, and then vacuum dry or air dry the product.

Notes:

21-10. TNP. 1,1,1,2-Tetranitropropane

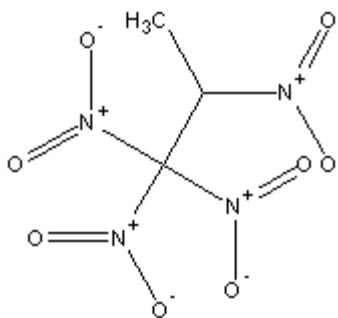

TNP

Tetranitropropane is a colorless, or slightly yellowish oily liquid with a boiling point of 235 Celsius. It is a high-energy plasticizer that can be efficiently used in plastic explosives and flexible sheet compositions with RDX, and HMX. It can also be used in high performance gun propellants, and rocket propellants—see TBA. TNP is a self-sufficient fuel widely used as an oxidizer in liquid rocket fuels, and as a high-energy fuel additive for jets and high performance aircraft. The liquid burns at a very high temperature making it suitable for liquid incendiary agents, or for gelled incendiary agents in combination with magnesium, aluminum, or phosphorus—it burns at a temperature of about 2800 Celsius. TNP is also widely used in making nitroglycerine free dynamites.

Molecular weight: 224.085	Flammability: Flammable
Detonating velocity: Uncalculated	Toxicity: Low
Sensitivity: Moderate	Classification: Secondary explosive
Stability: Moderate	Overall value (as secondary explosive): High

Procedure 21-10A: Preparation of TNP

Materials:	1. 78 grams nitroform
	2. 500 milliliters diethyl ether

	3. 49 grams of 1-bromo-1-nitroethane
	4. 100 grams of anhydrous sodium sulfate

Summary: TNP is easily prepared by the reaction between silver nitroform and 1-bromo-1-nitroethane in ether under reflux. The resulting mixture is then evaporated, the resulting liquid washed, and then dried. *Note: The silver bromide may be reduced to silver by heating powdered silver bromide with finely divided zinc in the presence of a small amount of hydrogen chloride gas. The free silver can be recycled back to silver oxide by first, reaction with dilute nitric acid containing a little hydrochloric acid, followed by recrystallization of the silver nitrate, then re-dissolving the silver nitrate into water, followed by treatment with a solution of sodium hydroxide. The resulting precipitate should be filtered-off, and then dried at 100 Celsius for several hours. Note: use an amber glass flask when drying to avoid contact with light.* Commercial & Industrial note: For related, or similar information, see Serial No. 647,433, February 13th, 1946, by Borg-Warner Corporation, to John A. Hannum, and Morris Fruman, Detroit MICH. Part or parts of this laboratory process may be protected by international, and/or commercial/industrial processes. Before using this process to legally manufacture the mentioned explosive, with intent to sell, consult any protected commercial or industrial processes related to, similar to, or additional to, the process discussed in this procedure. This process may be used to legally prepare the mentioned explosive for laboratory, educational, or research purposes.

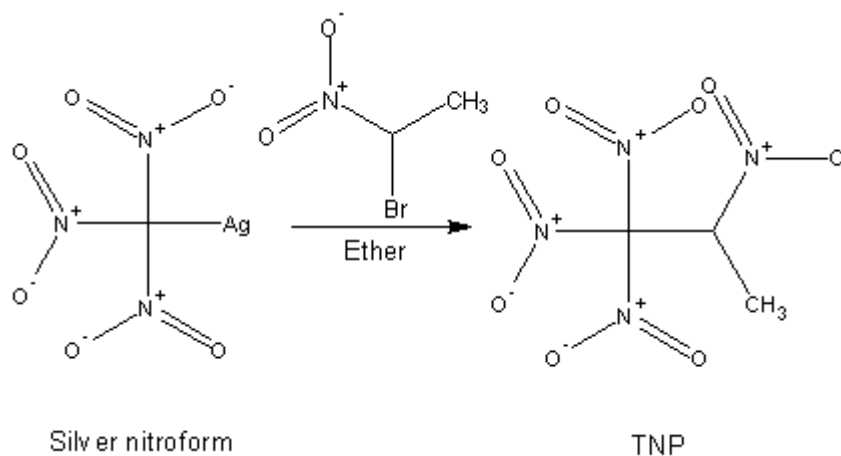

Reaction Equation

Hazards: Use proper ventilation and extinguish all flames before using ether. Ether is a narcotic (pain killer) in high concentrations, so avoid inhalation; although inhalation of ether is relatively non-habit forming and safe, vapors should be properly removed from the work area. Perform the peroxide test before using.

Procedure: Dissolve 78 grams of silver nitroform into 500 milliliters of diethyl ether; more ether may be needed dependant on the purity of the silver nitroform. Thereafter, reflux this ether solution at 30 to 40 Celsius. Shortly after the refluxing action begins, add 49 grams of 1-bromo-1-nitroethane over a moderately short period of time as to keep the temperature of the refluxing ether from rising above 40 Celsius. After the addition, continue to reflux for about 1 hour, and then remove the heat source. After the reaction mixture cools to room temperature, filter-off the precipitated silver bromide, and the place the filtered mixture into a rotary evaporator, and evaporate-off the ether until no more ether passes into the receiver flask. If a rotary evaporator is unavailable, place the filtered mixture into a distillation apparatus, and distill-off the ether until no more ether passes into the receiver flask. Thereafter, remove the liquid product remaining, and wash with six 150 milliliter portions of cold water. During each washing, filter-off any potential insoluble impurities if necessary. After each washing, the liquid product will be the bottom layer. After washing, dry the product over 100 grams of anhydrous sodium sulfate while stirring for ten minutes. Then filter-off the sodium sulfate, and then store the liquid in a suitable amber glass bottle in a cool place until use.

Notes:

21-11. TNEN. 2,2,2-Trinitroethyl-2-nitroxyethyl ether

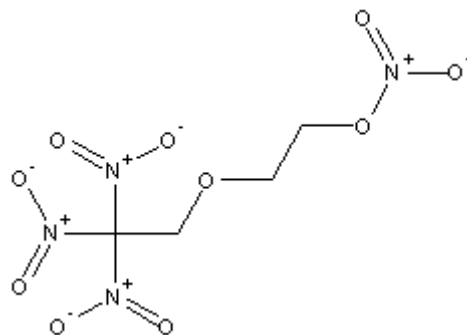

TNEN

TNEN is a colorless, or slightly yellow liquid with a melting point of 10 Celsius. It is by far the best high-energy plasticizer known, and is recommended over all others hands down. It has excellent physical properties and is very resistant to shock, friction, heat, and percussion. It is extensively used in making plastic bonded explosives and flexible sheet explosive with RDX and HMX, as a high-energy plasticizer for gun propellants and rocket propellants, and in a variety of dynamites with ammonium nitrate, nitroglycerine, or TNT. TNEN belongs to a class of high-energy plasticizers including butanetriol trinitrate (BTTN), metriol trinitrate (METN), and diethylene glycol dinitrate (DEGN).

Molecular weight: 270.11	Flammability: May burn on ignition
Detonating velocity: Uncalculated	Toxicity: Moderate
Sensitivity: Low	Classification: Secondary explosive
Stability: Moderate	Overall value (as secondary explosive): Very High

Procedure 21-11A: Preparation of TNEN

Materials:	1. 160 milliliters 1,2-dichloroethane
	2. 84 milliliters hexamethyldisilane
	3. 92 grams iodine
	4. 100 milliliters dry cyclohexene
	5. 60 milliliters of 1,3-dioxolane
	5. 152 grams of nitroform
	6. 1420 milliliters methylene chloride
	7. 200 milliliters dimethylformamide
	8. 200 grams anhydrous sodium sulfate
	9. 92 milliliters of 35 – 38% hydrochloric acid
	10. 100 grams anhydrous magnesium sulfate
	11. 272 milliliters 90% nitric acid
	12. 544 milliliters 98% sulfuric acid

Summary: TNEN is prepared in a four-step process starting with the formation of trimethylsilyl iodide. This compound is prepared by reacting hexamethyldisilane with iodine in the presence of 1,2-dichloroethane. The resulting mixture is then refluxed until the all the iodine has been used up. Then, the resulting mixture of trimethylsilyl iodide is then treated with 1,3-dioxolane in the presence of cyclohexene. The cyclohexene removes the hydrogen iodide formed in the reaction. The resulting iodomethyl-2-(trimethylsilyloxy)ethyl ether is treated with nitroform in methylene chloride. Afterwards, DMF is added, and the resulting mixture evaporated to remove the methylene chloride. The remaining residue is then treated with concentrated hydrochloric acid, and then treated with methylene chloride. The methylene chloride containing the 2,2,2-Trinitroethyl 2-hydroxyethyl ether mixture is then nitrated with a nitrating acid composed of 90% nitric acid and 98% sulfuric acid. After the nitration, the reaction mixture is poured into cold water, and the upper methylene chloride layer is removed, washed, dried, and then evaporated to remove the methylene chloride. Commercial & Industrial note: For related, or similar information, see Application No. 226,335, July 27th, 1988, by The United States Navy, to Michael E. Sitzmann, Adelphi, MD, and Horst G. Adolph, Burtonsville, MD. Part or parts of this laboratory process may be protected by international, and/or commercial/industrial processes. Before using this process to legally manufacture the mentioned explosive, with intent to sell, consult any protected commercial or industrial processes related to, similar to, or additional to, the process discussed in this procedure. This process may be used to legally prepare the mentioned explosive for laboratory, educational, or research purposes.

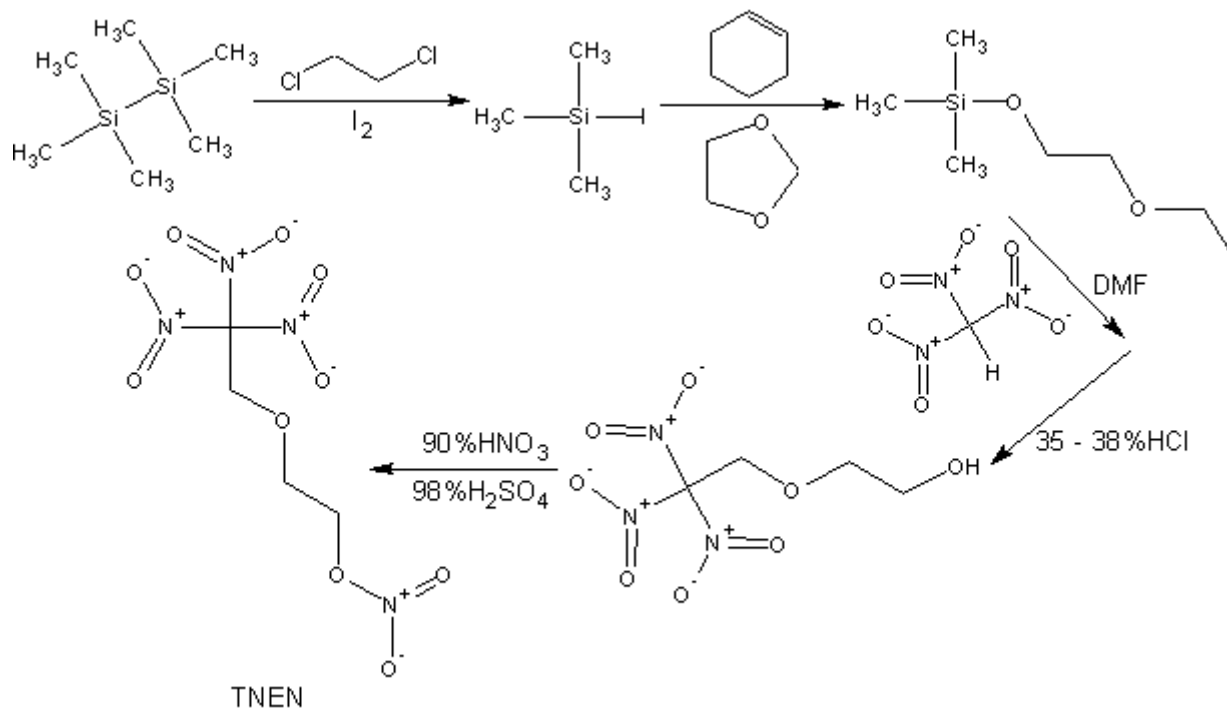

Reaction Equation

Hazards: Wear gloves and use proper ventilation when handling 90% nitric acid. The acid is highly volatile, and evolves poisonous fumes of nitrogen oxides. Avoid inhalation of fumes. Wear gloves when handling 98% sulfuric acid, dimethylformamide, 1,2-dichloroethane, iodine, and hexamethyldisilane. Avoid inhalation of iodine vapors, cyclohexene, and dimethylformamide. Cyclohexene is highly flammable. Wear gloves and use proper ventilation when handling 35 – 38% hydrochloric acid, and avoid inhalation of the fumes.

Procedure:

Step 1: Preparation of trimethylsilyl iodide

Place 160 milliliters of 1,2-dichloroethane into a 2-liter 3-neck flask equipped with a motorized stirrer, and thermometer. Then place this flask into a cold-water bath. Thereafter, add 84 milliliters of hexamethyldisilane all at once while stirring the 1,2-dichloroethane, and then stir for about 20 minutes. Then, add 92 grams of iodine in four 23 gram-portion, adding each portion at such a rate as to keep the reaction temperature below 10 Celsius. After adding the first portion, wait 30 minutes before adding the second portion of iodine. During each portion, stir the reaction mixture rapidly. After the addition of the second portion of iodine, reflux the mixture with stirring at 75 Celsius for 30 minutes until the color of iodine disappears. After which, remove the heat source and allow the reaction mixture to cool to room temperature. Then keep the mixture for the next step.

Step 2: Preparation of iodomethyl-2-(trimethylsilyloxy)ethyl ether

Place the mixture obtained in step 1 into a dry ice/acetone bath, and then add 100 milliliters of dry cyclohexene, and then 60 milliliters of dry 1,3-dioxolane. During the additions, rapidly stir the reaction mixture. After the addition, stir the reaction mixture for 1 hour. After stirring for 1 hour, keep the reaction mixture containing the iodomethyl-2-(trimethylsilyloxy)ethyl ether in the dry ice/acetone bath for step 3.

Step 3: 2,2,2-Trinitroethyl-2-hydroxyethyl ether

Prepare a nitroform solution by adding and dissolving 152 grams of nitroform into 750 milliliters of methylene chloride. Thereafter, add drop wise, this nitroform methylene chloride mixture to the iodomethyl-2-(trimethylsilyloxy)ethyl ether solution in the dry ice/acetone bath over a period of 40 minutes while rapidly stirring the iodomethyl-2-(trimethylsilyloxy)ethyl ether solution. After the addition, rapidly add 200 milliliters of dimethylformamide over a period of 10 minutes while stirring the reaction mixture. Afterwards, remove the dry ice/acetone bath, and allow the reaction mixture to warm to 0 Celsius while stirring. Then place the mixture into an ice bath, and cool at 0 Celsius for 30 minutes. Thereafter, add 1200 milliliters of ice water. Then, drain-off the bottom organic layer, and then extract the upper water layer with six 25-milliliter portions of

CHAPTER 21: THE PREPARATION OF NITRO PARAFFINS AND THEIR DERIVATIVES

methylene chloride. After the extraction process, combine all methylene chloride portions, if not already done so, and then add the combined methylene chloride to the previously removed bottom organic layer. Then dry the methylene chloride mixture over 100 grams of anhydrous sodium sulfate while stirring for ten minutes. Then filter-off the sodium sulfate, and then place the methylene chloride mixture into a rotary evaporator or distillation apparatus and remove the methylene chloride by either mild vacuum, or by careful distillation at 40 Celsius until no more methylene chloride is collected in the receiver flask. After which, take the remaining residue left behind, and place into a suitable flask. Thereafter, rapidly add 92 milliliters of 35 – 38% hydrochloric acid, and then heat this acid mixture to 60 Celsius with stirring for 2 hours. Thereafter, remove the heat source and allow the mixture to cool to room temperature. Then, add 60 milliliters of methylene chloride, and stir the mixture for ten minutes rapidly. Afterwards, remove the lower methylene chloride layer, and then wash with six 30-milliliter portions of cold water. After each washing, the methylene chloride mixture will be the bottom layer. Note: After each washing, keep each 30-milliliter portion of water used, and afterwards, combine them. Then extract this 180-milliliter portion of cold water with 60 milliliters of methylene chloride. Afterwards, remove the bottom methylene chloride layer, and add it to the washed methylene chloride mixture. Then dry the methylene chloride mixture with 100 grams of anhydrous sodium sulfate with stirring, and then filter-off the sodium sulfate. Then keep this dried methylene chloride mixture for step 4.

Step 4: Preparation of TNEN

Place 400 milliliters of methylene chloride into a beaker, and then add the dried methylene chloride mixture obtained in step 3 while stirring. Then prepare a nitrating acid mixture by placing 272 milliliters of 90% nitric acid into a suitable flask, then place this flask into an ice bath at 0 Celsius, and then carefully add 544 milliliters of 98% sulfuric acid. Thereafter, slowly add drop wise, the methylene chloride mixture at a rate sufficient to keep the nitrating acid mixture at 0 Celsius. During the addition, rapidly stir the nitrating acid mixture. After the addition, continue to stir the mixture at 0 Celsius for 3 hours. After which, pour the entire reaction mixture onto 1500 grams of ice contained in a beaker. Thereafter, when much of the ice has melted, remove the upper methylene chloride layer, wash with six 100-milliliter portions of cold water, and then dry over 100 grams of anhydrous magnesium sulfate while stirring. Note: After washing, the methylene chloride mixture will be the bottom layer, if sulfuric is present. After drying, place the methylene chloride mixture into a rotary evaporator, and evaporate-off the methylene chloride under mild vacuum until no more methylene chloride passes into the receiver flask. The result will be 150 grams of essentially pure 2,2,2-trinitroethyl-2-nitroxyethyl ether.

Notes:

Procedure 21-11B: Preparation of TNEN

Materials:	1. 2570 milliliters methylene chloride
	2. 82 grams 2-bromoethanol
	3. 20 grams trioxane
	4. 88 grams anhydrous aluminum chloride
	5. 150 grams anhydrous magnesium sulfate
	6. 49 grams potassium nitroform
	7. 120 milliliters dry acetone
	8. 400 milliliters of 5% baking soda solution
	9. 330 milliliters of hexanes
	10. 14 grams silver nitrate
	11. 70 milliliters acetonitrile

Summary: TNEN can be prepared in a modified process starting with 2-bromoethanol. The 2-bromoethanol is converted into chloromethyl-2-bromoethyl ether by reaction with methylene chloride in the presence of trioxane and aluminum chloride. The resulting product is then poured onto ice, and then extracted with additional methylene chloride. The solvent is then removed under vacuum, and the resulting residue fractionally distilled to yield the pure intermediate, chloromethyl-2-bromoethyl ether. The resulting chloromethyl-2-bromoethyl ether is converted into 2,2,2-trinitroethyl-2-bromoethyl ether by reaction with potassium nitroform in acetone. Thereafter, the reaction mixture is added to cold water, and the resulting mixture extracted with methylene chloride. The methylene chloride is then removed, and the resulting liquid purified by passing through silica gel using a hexanes/methylene chloride eluent. The nitro intermediate is then recovered by evaporation of the solvent mixture. This nitro intermediate is then converted into TNEN by the addition of silver nitrate in acetonitrile. The resulting mixture is then filtered, washed, dried, and then evaporated to yield the crude product. Purification is again accomplished by treatment

CHAPTER 21: THE PREPARATION OF NITRO PARAFFINS AND THEIR DERIVATIVES

with silica gel absorbent. Commercial & Industrial note: For related, or similar information, see Application No. 43,267, April 27th, 1987, by The United States Navy, to Horst G. Adolph, Silver Springs, MD, and Kyung E. Kim, Potomac, MD. Part or parts of this laboratory process may be protected by international, and/or commercial/industrial processes. Before using this process to legally manufacture the mentioned explosive, with intent to sell, consult any protected commercial or industrial processes related to, similar to, or additional to, the process discussed in this procedure. This process may be used to legally prepare the mentioned explosive for laboratory, educational, or research purposes.

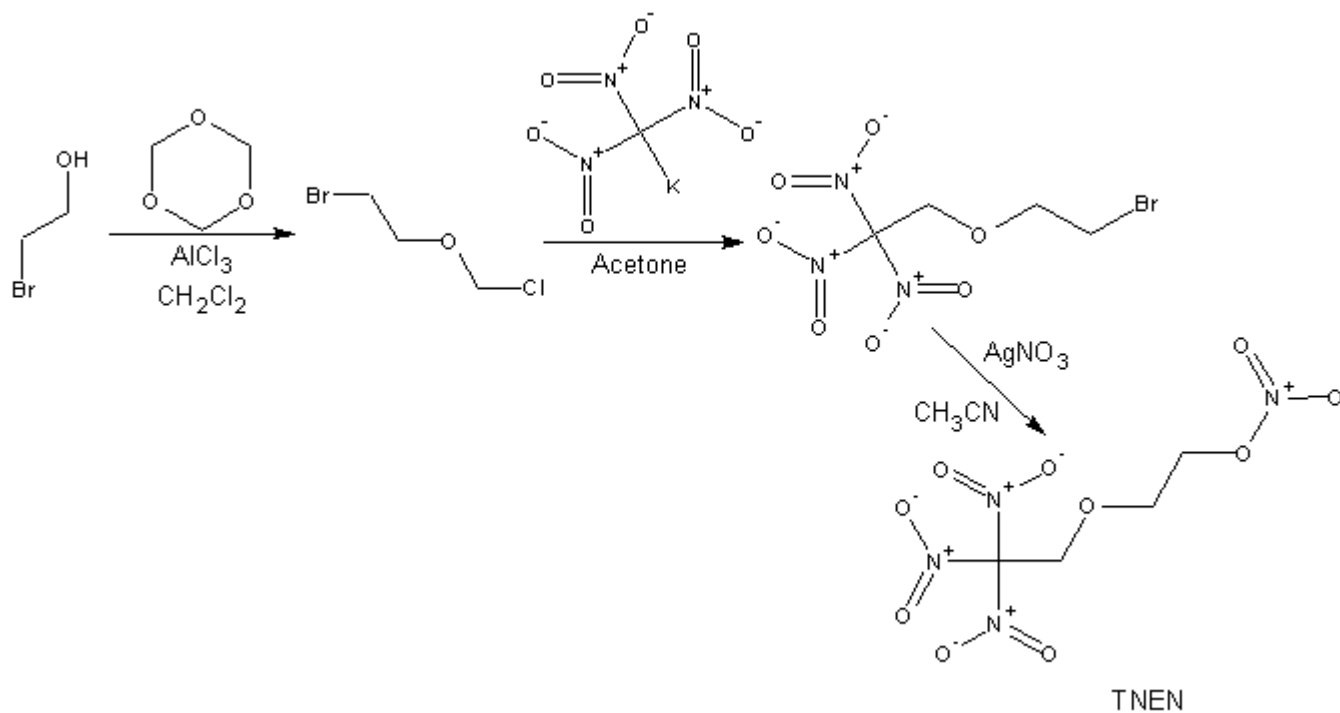

Reaction Equation

Hazards: Wear gloves and use proper ventilation when handling 2-bromoethanol, and avoid inhalation or skin absorption. 2-Bromoethanol is very irritating. Use ventilation and extinguish all flames before using acetone or acetonitrile. Use caution when handling anhydrous aluminum chloride, which is volatile and reacts violently with water evolving hydrogen chloride gas.

Procedure:

Step 1: Preparation of chloromethyl-2-bromoethyl ether

Into a 3-neck flask place 500 milliliters of methylene chloride, and then add and dissolve 82 grams of 2-bromoethanol, and then 20 grams of trioxane. Thereafter, add rapidly add 88 grams of anhydrous aluminum chloride, but a rate sufficient to keep the reaction mixtures temperature from rising to a point where rapid boiling of the methylene chloride takes place. During the addition, rapidly stir the methylene chloride mixture. After the addition, rapidly stir the whole mixture for 4 hours. Then, pour the entire reaction mixture onto 1000 grams of ice contained in a beaker. After the ice has melted, extract the entire mixture with six 150-milliliter portions of methylene chloride. After the extractions, combine all methylene chloride portions, if not already done so, and then rapidly wash with four 100-milliliter portions of cold water. Note: during the extractions, and the washings, the methylene chloride will be the bottom layer. After washing, dry the methylene chloride mixture over 100 grams of anhydrous magnesium sulfate while stirring for 10 minutes, and then filter-off the magnesium sulfate. Then place the methylene chloride mixture into a rotary evaporator, or distillation apparatus and remove the methylene chloride via vacuum, or by careful distillation until no more methylene chloride passes into the receiver flask. Thereafter, place the remaining residue into a fractional distillation apparatus, and distill at 84 Celsius at 20 millimeters of mercury. The result will be 45 grams of chloromethyl-2-bromoethyl ether.

Step 2: Preparation of 2,2,2-trinitroethyl 2-bromoethyl ether

Into a 3-neck flask place 49 grams of potassium nitroform and then add 120 milliliters of water free acetone and stir the mixture rapidly. Thereafter, steadily add, drop wise, 42 grams of the product obtained in step 1. During the addition, stir the

CHAPTER 21: THE PREPARATION OF NITRO PARAFFINS AND THEIR DERIVATIVES

reaction mixture rapidly. After the addition, stir the reaction for 48 hours. After stirring for 48 hours, pour the entire reaction mixture into 1000 milliliters of cold water, and then stir the mixture rapidly for about 3 hours. Thereafter, extract the entire mixture with six 150-milliliter portions of methylene chloride, and then after the extraction, combine all methylene chloride portions, if not already done so. Then, wash the methylene chloride mixture with 200 milliliters of 5% baking soda solution, and then dry over 40 grams of anhydrous magnesium sulfate while stirring for 10 minutes. After which, filter-off the magnesium sulfate and then place the filtered methylene chloride into a rotary evaporator or distillation apparatus and remove the methylene chloride under vacuum, or by careful distillation until no more methylene chloride collects in the receiver flask. Afterwards, remove the crude liquid residue from the apparatus, and then pass this liquid through a column filled with silica gel. Shortly after pouring the liquid product into the column, pass through, six 50-milliliter portions of a solvent mixture prepared by dissolving 150 milliliters of hexanes into 150 milliliters of methylene chloride. Thereafter, Place all the collected liquids (a two phase mixture may exist), into a rotary evaporator or vacuum distillation apparatus, and remove the hexanes and methylene chloride under vacuum until no more hexanes and methylene chloride passes into the receiver flask. The result will be a liquid product composed of 22 grams, with a melting point of 2 Celsius.

Step 3: Preparation of TNEN

Into a 3-neck flask, place 14 grams of silver nitrate, and then add 70 milliliters of dry acetonitrile. After adding the acetonitrile, stir the mixture rapidly to dissolve the silver nitrate. Thereafter, place the mixture into an ice bath, and then add drop-wise, 21 grams of the trinitro-2-bromoethyl ether (prepared in step 2) at a rate sufficient to keep the reaction temperature below 10 Celsius. During the addition, rapidly stir the reaction mixture. After the addition, heat the reaction mixture to 45 Celsius for 7 days with constant stirring. After 7 days, filter the mixture to remove insoluble impurities, and then wash the insoluble impurities with six 50-milliliter portions of methylene chloride; collect the methylene chloride into the filtered reaction mixture. Thereafter, wash the reaction mixture with 200 milliliters of 5% baking soda solution, (the reaction mixture will be the bottom layer), dry over 50 grams of anhydrous magnesium sulfate while stirring for 10 minutes, then filter-off the magnesium sulfate, and then place the filtered reaction mixture containing the methylene chloride wash, into a rotary evaporator or vacuum distillation apparatus, and remove the acetonitrile and methylene chloride under vacuum. When no more acetonitrile and methylene chloride is collected in the receiver flask, remove the liquid residue and pass it through a column filled with silica gel. Shortly after pouring the liquid into the silica gel column, pass six 50-milliliter portions of a solvent mixture prepared by dissolving 180 milliliters of hexanes into 120 milliliters of methylene chloride. Thereafter, place all the collected liquids (a two phase liquid may result) into a rotary evaporator or vacuum distillation apparatus, and remove the solvents under vacuum until no more solvent collects in the receiver flask. The result will be about 7 grams of liquid TNEN product.

Notes:

21-12. NTND. 2-Methyl-2-(N-nitro-N-trinitroethylamino)-1,3-propyl dinitrate

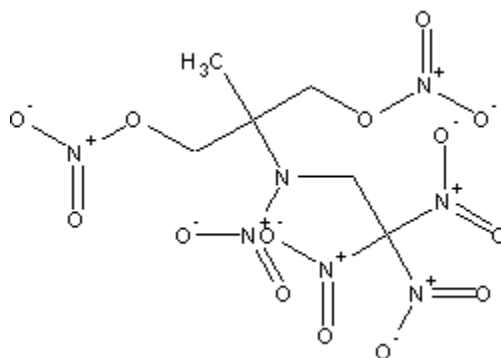

NTND

NTND is a colorless, or colored, viscous oily liquid. It is another high-energy plasticizer with great physical properties including resistance to shock, friction, and percussion. It is commonly used as a substitute for other high-energy plasticizers in

CHAPTER 21: THE PREPARATION OF NITRO PARAFFINS AND THEIR DERIVATIVES

plastic bonded explosives and flexible sheet explosives with RDX, and HMX, as a chief component of high-energy gun propellants, rocket propellants, and in the manufacture of dynamites with ammonium nitrate, picric acid, nitrocellulose, or TNT. NTND is capable of gelatinizing nitrocellulose and nitro starch for use in blasting compositions.

Molecular weight: 403.173	Flammability: Flammable
Detonating velocity: Uncalculated	Toxicity: Low
Sensitivity: Moderate	Classification: Secondary explosive
Stability: Moderate	Overall value (as secondary explosive): High

Procedure 21-12A: Preparation of NTND

Materials:	1. 21 grams 2-methyl-2-amino-1,3-propanediol
	2. 30 grams nitroform
	3. 17 milliliters of 37% formaldehyde solution
	4. 300 milliliters 95% ethanol
	5. 70 grams anhydrous magnesium sulfate
	6. 100 milliliters acetic anhydride
	7. 60 milliliters 90% nitric acid
	8. 200 milliliters 10% baking soda solution

Summary: NTND is prepared by first, reacting 2-methyl-2-amino-1,3-propanediol with nitroform, and formaldehyde solution to form a trinitro intermediate. This intermediate is then treated with 90% nitric acid in the presence of acetic anhydride to yield the desired oily product. The oily product is then recovered by mixing the oily product with ice, and then separating the insoluble oily liquid. The liquid is then washed, and dried. Commercial & Industrial note: For related, or similar information, see Serial No. 790,377, February 2nd, 1959, by Purdue Research Foundation, to Henry Feuer, Lafayette, IN. Part or parts of this laboratory process may be protected by international, and/or commercial/industrial processes. Before using this process to legally manufacture the mentioned explosive, with intent to sell, consult any protected commercial or industrial processes related to, similar to, or additional to, the process discussed in this procedure. This process may be used to legally prepare the mentioned explosive for laboratory, educational, or research purposes.

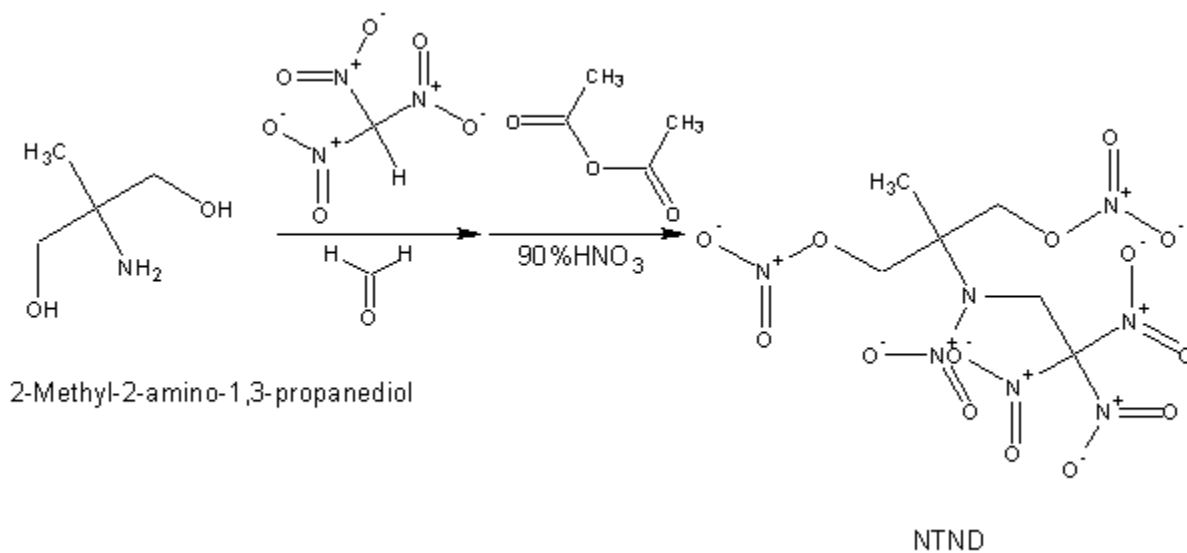

Reaction Equation

Hazards: Wear gloves and use proper ventilation when handling 90% nitric acid. The acid is highly corrosive and toxic, which evolves highly poisonous fumes of nitrogen oxides. Use great care. Use proper ventilation when handling 37% formaldehyde solution, which is volatile. Avoid inhalation of the vapors. 95% ethanol, and acetic anhydride are flammable, so extinguish all flames before using.

Procedure: Prepare a solution by adding 21 grams of 2-methyl-2-amino-1,3-propanediol, 30 grams of nitroform, and 17 milliliters of 37% formaldehyde solution into 70 milliliters of distilled water. After preparing the solution, place the solution into an ice bath, and chill to 0 Celsius for 3 hours with rapid stirring. After 3 hours, place the mixture into a rotary evaporator or vacuum distillation apparatus, and remove the water under vacuum until no more water passes into the receiver flask.

CHAPTER 21: THE PREPARATION OF NITRO PARAFFINS AND THEIR DERIVATIVES

Thereafter, remove the oily residue remaining, and dissolve it into 300 milliliters of 95% ethanol. Afterwards, dry this ethanol solution over 50 grams of anhydrous magnesium sulfate with stirring for 10 minutes. After which, filter-off the magnesium sulfate, and then place the filtered mixture into a rotary evaporator, and evaporate-off the ethanol under vacuum until no more ethanol is collected in the receiver flask. When the ethanol has been removed, remove the oily liquid residue remaining, and dissolve it into 100 milliliters of acetic anhydride. Thereafter, place this mixture into an ice bath and chill to 5 Celsius. Afterwards, gradually add 60 milliliters of 90% nitric acid over a period of 3 hours while stirring the acetic anhydride mixture and maintaining its temperature below 20 Celsius. After the addition, continue to stir the reaction mixture for 2 hours at a temperature below 20 Celsius. Thereafter, pour the entire reaction mixture onto 500 grams of crushed ice. Then stir this ice mixture for about 30 minutes, and then remove the bottom oily layer, wash with 200 milliliters of 10% baking soda solution, and then with six 50-milliliter portions of cold water. After each washing, the oily liquid product will be the bottom layer. After washing, dry the oily liquid product over 20 grams of anhydrous magnesium sulfate with stirring for 10 minutes. Thereafter, filter-off the magnesium sulfate, and then store the liquid oily product into an amber glass bottle until use.

Notes:

CHAPTER 22: MISCELLANEOUS

TNA, TND, NITROGUANIDINE, NITROUREA, ACETONE-P, TETRACENE

22-01. TNA. 1,3,5,7-Tetranitroadamantane

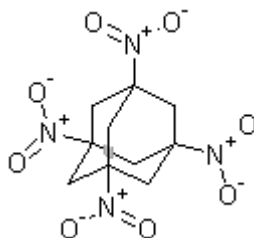

TNA

TNA forms colorless to white to yellowish crystals, which are highly resistant to shock, heat, friction, and percussion. It is a powerful explosive with high thermal stability, and is used in the manufacture of specialty explosives charges for fighting oil wells, forest clearing, line charges, and for missile warheads. The cost of TNA production is rather high, so its use in explosives is limited.

Molecular weight: 320.258	Flammability: Burns with smoky flame, but may flash on ignition
Detonating velocity: 7800 (estimated) also reported as 8000	Toxicity: Low
Sensitivity: Very low	Classification: Secondary explosive
Stability: Very good	Overall value (as secondary explosive): Moderate

Procedure 22-01A: Preparation of TNA

Materials:	1. 114 grams potassium permanganate
	2. 54 grams adamantane
	3. 704 grams bromine
	4. 42 milliliters of 10% sodium sulfite solution
	5. 120 milliliters of 18% hydrochloric acid
	6. 2400 milliliters glacial acetic acid
	7. 40 grams aluminum foil
	8. 1100 milliliters toluene
	9. 480 milliliters methylene iodide
	10. 1600 milliliters acetonitrile
	11. 400 milliliters of tetrahydrofuran
	12. 300 milliliters of 10% sodium hydroxide solution
	13. 620 milliliters acetone
	14. 21 grams magnesium sulfate
	15. 54 grams anhydrous aluminum chloride
	16. 100 milliliters of chloroform

Summary: TNA, 1,3,5,7-Tetranitroadamantane, is prepared in a five-step process starting with adamantane. Adamantane is converted to 1,3,5,7-Tetrabromoadamantane, which in turn is converted to 1,3,5,7-Tetraiodoadamantane. 1,3,5,7-Tetraacetamidoadamantane is then prepared from the 1,3,5,7-Tetraiodoadamantane. 1,3,5,7-Tetraacetamidoadamantane is then converted to 1,3,5,7-Tetraaminoadamantane tetrahydrochloride, which is then treated with base to liberate the free base. The free base, 1,3,5,7-Tetraaminoadamantane is then oxidized with potassium permanganate to the corresponding 1,3,5,7-Tetranitroadamantane. Commercial & Industrial note: For related, or similar information, see Application No. 196,956, October 14, 1980, by The United States Army, to Everett E. Gilbert, Morristown, NJ, Gilbert P. Sollott, Plymouth Meeting, PA. Part or parts of this laboratory process may be protected by international, and/or commercial/industrial processes. Before using this process to legally manufacture the mentioned explosive, with intent to sell, consult any protected commercial or

industrial processes related to, similar to, or additional to, the process discussed in this procedure. This process may be used to legally prepare the mentioned explosive for laboratory, educational, or research purposes.

Hazards: Warning! Wear gloves and use proper ventilation when handling bromine. Bromine is a highly volatile liquid evolving choking poisonous fumes. Use caution. Use gloves and proper ventilation when handling hydrochloric acid. Hydrochloric acid evolves choking and corrosive fumes. Glacial acetic acid can cause skin burns. Use proper ventilation when handling acetone, and tetrahydrofuran.

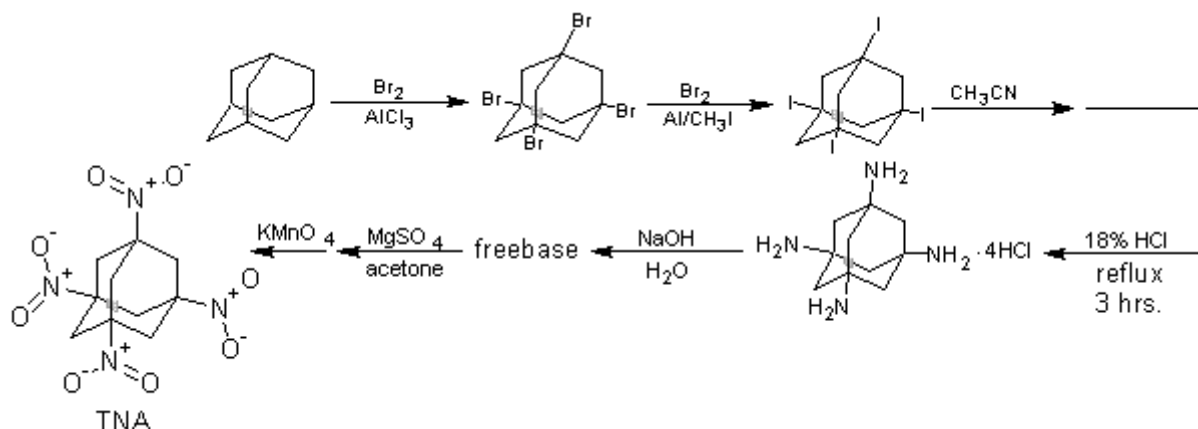

Reaction Equation

Procedure:

Step 1: Preparation of 1,3,5,7-Tetrabromoadamantane

Add 700 grams of bromine to a 2-liter flask and cool to 5 Celsius with an ice bath. Then add 54 grams of anhydrous aluminum chloride while stirring. Afterwards, add 54 grams of adamantane portion wise, over a period of 1 hour, while maintaining the temperature at 5 Celsius while stirring. After addition of the adamantane, remove the 2-liter flask from the ice bath, and then heat the 2-liter flask to 70 Celsius for 24 hours. Hydrogen bromide is evolved steadily during the addition and heating, so use an apparatus illustrated in figure 068 to recycle the bromine. After 24 hours, add 40 milliliters of a 10% sodium sulfite solution (to remove excess bromine), after which, add 200 milliliters of a 18% hydrochloric acid solution (to dissolve aluminum salts). Then, filter-off the solid product, and then wash the product with 1000 milliliters of cold water. Then air-dry or vacuum dry the product. The product will weigh 182 grams. Thereafter, recrystallize the product from 2400 milliliters of glacial acetic acid, followed by washing with 400 milliliters of cold water. Then vacuum dry or air-dry the product. The pure product will weigh 104 grams, and will be in the form of a tan powder, with a melting point of 245 Celsius.

Step 2: Preparation of 1,3,5,7-Tetraiodoadamantane

Place 480 milliliters of methylene iodide into a flask, and then add 40 grams of aluminum foil. Then heat the flask to 80 Celsius. Afterwards, add 4 grams of bromine, and then stir at 80 Celsius for 60 minutes. Afterwards, add 40 grams of 1,3,5,7-tetrabromoadamantane (prepared in step 1), in one portion, and then continue stirring for 30 minutes at 80 Celsius. After 30 minutes, remove the heat source and cool the reaction mixture to room temperature. When room temperature is achieved, pour the entire reaction mixture into 800 milliliters of cold water while stirring the cold water. Afterwards, add 2 milliliters of a 10% sodium sulfite solution to remove any excess bromine. Then drain-off the bottom methylene iodide layer using a separatory funnel, and then mix the methylene iodide layer with 1000 milliliters of water while stirring the water. After which, drain-off the bottom methylene iodide layer using a separatory funnel, and then place the methylene iodide layer into a vacuum distillation apparatus and distill-off the methylene iodide at 80 to 100 Celsius under a moderate vacuum until dry solid remains (use a rotary evaporator if available). When dry product is obtained, stop the distillation, and then collect the dry product from the apparatus. Then wash the product with 100 milliliters of chloroform, and then with 100 milliliters of acetone. Then, recrystallize the product from 300 milliliters of toluene. Afterwards, wash with 400 milliliters of water, and then vacuum dry or air-dry the product. The product will weigh 42 grams, and will be in the form of crystalline needles with a melting point of 370 Celsius.

Step 3: Preparation of 1,3,5,7-Tetraacetamidoadamantane

CHAPTER 22: MISCELLANEOUS

Place 1600 milliliters of acetonitrile into a 2-liter flask equipped with a condenser and stirrer, and then add 15 grams of 1,3,5,7-tetraiodoadamantane (prepared in step 2). Then place the mixture into a photolyzer and then photolyze for 64 hours at approximately 60 Celsius in a Rayonet Photochemical Reactor containing 16 lamps, each lamp approximately 0.03 watt, 1849 angstroms and 2.2 watts, 2537 angstroms (manufacturer's literature: The Southern New England Ultraviolet Co., Middletown, CT). After which, remove the reaction mixture from the photolyzer, and then filter-off some of the product (keep the filtered liquid). Then wash this portion of filtered-off product with 100 milliliters of tetrahydrofuran, and then air-dry this portion of the product to obtain a dark tarry residue. Then, place the filtered liquid from before into a rotary evaporate, and evaporate-off the acetonitrile under vacuum until no more acetonitrile collects in the receiver flask. When this is achieved, remove the dark tarry residue from the rotary evaporator, and then combine both portions of dark tarry residue. Thereafter, mix this dark tarry residue with 200 milliliters of tetrahydrofuran. Afterwards, filter-off the pale yellow solids which remain undissolved, and then wash these pale yellow solids with 100 milliliters of tetrahydrofuran, and then air dry. Then dissolve these solids into 1000 milliliters of hot water, and stir the mixture rapidly. Then add 100 milliliters of a 10% sodium hydroxide solution, and stir the mixture for 20 minutes. Thereafter, filter the mixture to remove any insoluble impurities. Afterwards, evaporate the filtered mixture to dryness to obtain a residue (heat the mixture to 100 Celsius to boil-off the water), and then wash the dry residue with 100 milliliters of acetone, then 200 milliliters of cold water, and then with 100 milliliters of acetone. After all these washings, air-dry the product. The result will be 5 grams of 1,3,5,7-tetraacetamidoadamantane having a melting point of 360 Celsius.

Step 4: Preparation of 1,3,5,7-Tetraaminoadamantane tetrahydrochloride

Dissolve 4 grams of 1,3,5,7-Tetraacetamidoadamantane (prepared in step 3) into 120 milliliters of 18% hydrochloric acid, and then reflux the solution for three hours at 100 Celsius. After 3 hours, remove the heat source and allow the mixture to cool to room temperature. Then, filter-off the crystalline product, wash with 100 milliliters of acetone, and then air dry. The result will be 2.5 grams of product having a melting point of 360 Celsius.

Step 5: Preparation of 1,3,5,7-Tetranitroadamantane

Repeat steps 1 through 4 twice more to obtain a total of 10 grams of 1,3,5,7-Tetraaminoadamantane tetrahydrochloride, and then dissolve this 10 grams into 400 milliliters of water. Then add 200 milliliters of 10% sodium hydroxide, and stir the mixture for 20 minutes. Afterwards, heat the mixture to 30 Celsius, and then add 21 grams of anhydrous magnesium sulfate (stir the mixture during the addition of the anhydrous magnesium sulfate). After adding the anhydrous magnesium sulfate, rapidly add 300 milliliters of acetone. Then slowly add 114 grams of potassium permanganate, portion wise, over a 60-minute period while stirring the mixture and maintaining its temperature at 30 Celsius. After the addition of the potassium permanganate, stir the mixture at 30 Celsius for 48 hours. After 48 hours, remove the heat source and allow the mixture to cool to room temperature. Then extract the reaction mixture with sixteen 50-milliliter portions of boiling toluene. The toluene will be the upper layer each time. Then combine all 16 portions of toluene (if not already done so), and then allow the toluene to cool to room temperature. Then filter the toluene to remove any insoluble impurities. After filtration, place the toluene into a rotary evaporator, and evaporate-off the toluene under vacuum until the total volume of the remaining liquid equals approximately 150 milliliters. When this volume is achieved, stop the evaporation, and then place this remaining 150 milliliters into a beaker, and then allow it to stand at room temperature for three days. After 3 days, recover the crystalline solid product by filtration, and then air-dry the product. The dry product obtained will weigh 2.5 grams, and will be in the form of square pyramidal crystals having a melting point of 360 Celsius (with decomposition). Then, evaporate the remaining toluene solution to dryness to yield 1.7 grams of additional product. After which, air-dry this portion of product. Both combined dry portions of product will have a total weight of 4.2 grams.

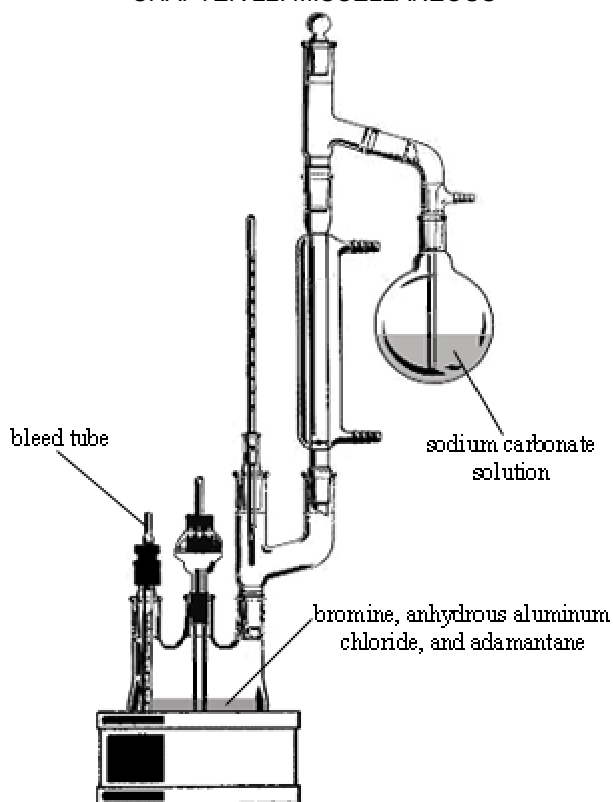
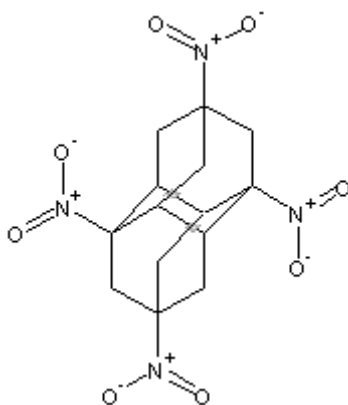

Figure 068. Apparatus used in step 1, for the recovery of bromine. The sodium carbonate solution neutralizes the hydrogen bromide forming sodium bromide dihydrate, which is recovered by recrystallization. The sodium bromide can be recycled back to bromine by the addition of chlorine.

Notes:

22-02. TND. *1,4,6,9-Tetranitrodimantane*



TND

TND forms colorless, or lightly colored crystals with a melting point of 370 Celsius (with decomposition beginning). It is highly resistant to shock, friction, heat, and percussion, and is used in the same manner as TNA. The high cost of production limits its use.

Molecular weight: 368.299	Flammability: Burns with smoky flame, but may flash on ignition
Detonating velocity: Similar to TNA	Toxicity: Low
Sensitivity: Very low	Classification: Secondary explosive
Stability: Very good	Overall value (as secondary explosive): Moderate

Procedure 22-02A: Preparation of TND

Materials:	1. 24 grams aluminum foil
	2. 56 grams iodine powder
	3. 2000 milliliter carbon disulfide
	4. 48 grams 1,4,6,9-tetrabromodiamantane
	5. 3000 milliliters sodium bisulfite solution
	6. 2000 milliliters 5% hydrochloric acid
	7. 3400 milliliters methanol
	8. 6000 milliliters acetonitrile
	9. 360 milliliters 35 – 38% hydrochloric acid
	10. 900 milliliters acetone
	11. 2 grams sodium hydroxide
	12. 4.8 grams anhydrous magnesium sulfate
	13. 26.4 grams potassium permanganate
	14. 600 milliliters toluene

Summary: TND is prepared in a four-step process starting with the preparation of tetraiododiamantane. This tetraiodo compound is prepared by reacting the tetrabromo compound with iodine in the presence of aluminum. The reaction is carried out in the presence of carbon disulfide. After the reaction, the mixture is filtered, washed with acid, and the product collected by filtration. The resulting product is then mixed with acetonitrile, and then photoylzed in a photo machine for 120 hours. The resulting acetamido intermediate obtained, is then recovered by filtration, dried and then refluxed with hydrochloric acid. This refluxing period decomposes the acetamido intermediate into the resulting amino hydrochloride derivative. This amino hydrochloride derivative is recovered by filtration, washed, and dried. The dried amino hydrochloride derivative is then converted to the freebase by addition of sodium hydroxide, and then oxidized to the nitro compound by the addition of potassium permanganate. The mixture is then gently heated for 48 hours, and the resulting product is then obtained by filtration. Purification is accomplished by dissolving in acetone, followed by precipitation by the addition of water. The precipitated powdery product is then collected and dried. Commercial & Industrial note: For related, or similar information, see Application No. 586,364, March 5th, 1984, by The United States Army, to Gilbert P. Sollott, Plymouth Meeting, PA, Everett E. Gilbert, Morristown, NJ. Part or parts of this laboratory process may be protected by international, and/or commercial/industrial processes. Before using this process to legally manufacture the mentioned explosive, with intent to sell, consult any protected commercial or industrial processes related to, similar to, or additional to, the process discussed in this procedure. This process may be used to legally prepare the mentioned explosive for laboratory, educational, or research purposes.

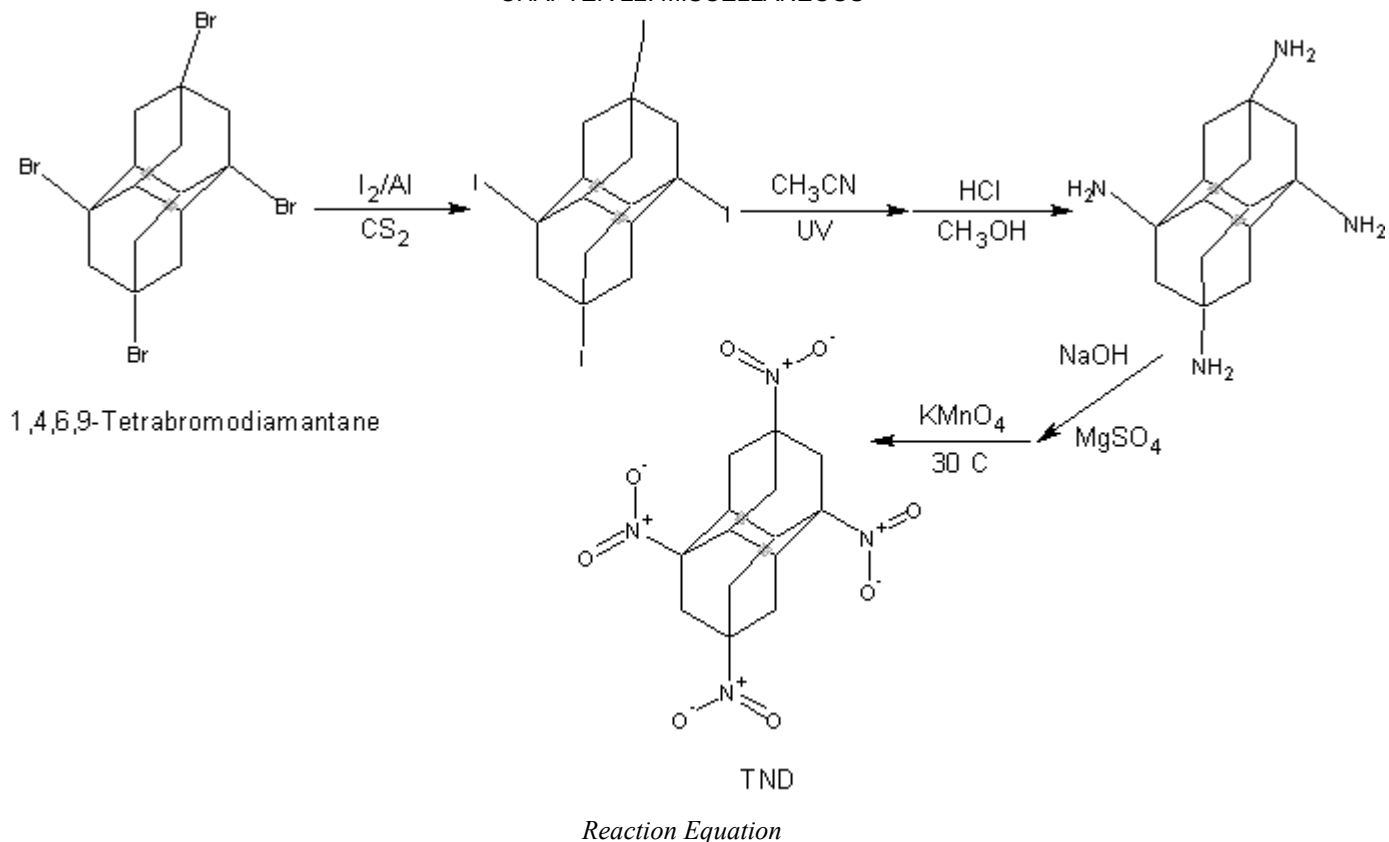

Hazards: Wear gloves and use proper ventilation when handling carbon disulfide and iodine. Carbon disulfide is highly toxic and can be absorbed by the skin. Avoid inhalation of carbon disulfide vapors, and iodine vapors. Use proper ventilation when handling methanol, acetonitrile, and concentrated hydrochloric acid. Avoid inhalation of the vapors and skin contact. Limit exposure to toluene vapors. Toluene may be a mild carcinogen.

Procedure:

Step 1: Preparation of 1,4,6,9-tetraiododiamantane

Into a 3-neck flask fitted with a motorized stirrer, condenser, and addition funnel, add 24 grams of aluminum foil (in the form of pieces), and then add 56 grams of iodine powder. Then heat the mixture to 80 Celsius and manually blend until some of the iodine vaporizes and coats the foil. Then reduce the heat to 60 Celsius, and then add 2000 milliliters of carbon disulfide. Thereafter, reflux the contents in the 3-neck flask at 60 Celsius for 1 hour. Afterwards, remove the heat source and allow the mixture to cool to room temperature. Thereafter, add 48 grams of 1,4,6,9-tetrabromodiamantane, and then stir the reaction mixture for 3 hours at room temperature. Then, place the reaction mixture into a cold-water bath, and then add 3000 milliliters of 10% sodium bisulfite solution while stirring the reaction mixture. Afterwards, filter-off the precipitated product (some aluminum foil and other insolubles will be collected on the filter as well), and then vacuum dry the filtered-off solids, and then mix thoroughly with 2000 milliliters of 5% hydrochloric acid to dissolve the aluminum. Then filter-off the insoluble product, wash with several hundred milliliters of warm water, and then with 2500 milliliters of cold methanol. Then vacuum dry or air-dry the product. The result will be 54 grams of the tetraiodo compound.

Step 2: The preparation of 1,4,6,9-tetraacetamidodiamantane

Into a small cylindrical quartz reaction vessel equipped with a motorized stirrer, and condenser, place 20 grams of the product obtained in step 1, and then add 5000 milliliters of acetonitrile followed by 5 milliliters of water. Then briskly stir this mixture for 10 minutes. Thereafter, photolyze the mixture for 120 hours using a Rayonet Photochemical Reactor containing 16 lamps, each lamp approximately 0.03 watt, 1849 angstroms, and 2.2 watts at 2537 angstroms while refluxing the mixture at about 80 Celsius (note: this photo machine is available through the Southern New England Ultraviolet Co., Middleton, CT). Thereafter, remove the reaction mixture from the photo machine and then filter-off the gray insoluble solids. Then wash these gray solids with 1000 milliliters of fresh acetonitrile, several times using the same washing portion, and the vacuum dry or air-dry the product. The result will be 8 grams of the desired acetamido intermediate.

Step 3: Preparation of 1,4,6,9-tetraaminodiamantane hydrochloride

Into a suitable flask, add 6 grams of the product obtained in step 3, and then add 360 milliliters of 35 – 38% hydrochloric acid, followed by 360 milliliters of water. Thereafter, reflux the mixture for 18 hours at about 100 Celsius. After the 18 hour refluxing period, remove the heat source, and allow the reaction mixture to cool to room temperature. Then place the reaction mixture into a rotary evaporator, and remove the water under vacuum. Afterwards, mix the residue remaining with 600 milliliters of methanol, and stir the mixture for 10 minutes. Thereafter, filter-off the insoluble solid, wash with 300 milliliters of methanol, and then vacuum dry or air-dry these solids. After which, dissolve the dry solids into a minimum amount of cold water, and then filter-off any insoluble materials. Thereafter, mix 600 milliliters of acetone with the water mixture to precipitate the desired product. Then filter-off the precipitated product, and then vacuum dry or air-dry. The result will be about 4 grams of the dry product.

Step 4: Preparation of 1,4,6,9-tetranitrodiamantane

Into a flask add 100 milliliters water, and then add and dissolve 2.68 grams of the product obtained in step 3. Then prepare a sodium hydroxide solution by dissolving 2 grams of sodium hydroxide into 3 milliliters of water. Thereafter, add this sodium hydroxide solution to the solution containing the hydrochloride (obtained in step 3), and stir the solution for 10 minutes. After the mixing period, add 4.8 grams of anhydrous magnesium sulfate, and then rapidly stir the mixture. Afterwards, add 40 milliliters of acetone and continue to stir the reaction mixture rapidly for 10 minutes. Then, add portion wise, 26.4 grams of potassium permanganate over a period of 40 minutes while rapidly stirring the reaction mixture. After which gently heat the reaction to 30 Celsius and heat for 48 hours while rapidly stirring the reaction mixture. After heating and stirring for 48 hours, filter-off the precipitated solids, and then wash with 100 milliliters of warm water, and then vacuum dry or air-dry the solid product. Thereafter, extract the dried solids with four 150-milliliter portions of boiling toluene. Afterwards, combine the 4 toluene portions, if not already done so, and then filter this toluene mixture (to remove any insoluble impurities), and then place the toluene mixture into a rotary evaporator, and evaporate-off the toluene under vacuum until no more toluene remains. When this is accomplished, stop the evaporation process, and cool the mixture to room temperature. Thereafter, dissolve the remaining solids into 300 milliliters of acetone, and then add 300 milliliters of cold water to precipitate the dried product as a fine powdery substance. Then vacuum dry or air-dry the product. The result will be about 800 milligrams of TNB with a melting point of 370 Celsius.

Notes:

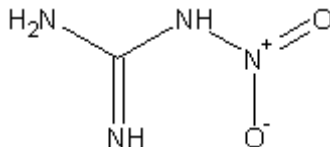
22-03. Nitroguanidine.

Nitroguanidine

Nitroguanidine forms white or colorless needles, or prisms, which begin to decompose when heated to 225 Celsius—evolving ammonia. The crystals are insoluble in water and alcohol, but soluble in concentrated acids, from where the corresponding acid salt is precipitated by pouring into cold water—the nitrate and perchlorate salts are quite common and are used in fireworks, and a variety of pyrotechnic compositions. Nitroguanidine usually occurs as the alpha form, but the beta form can be prepared by treating guanidine sulfate with 90% nitric acid. The beta form is converted back to the alpha form by treatment with sulfuric acid, from which the sulfate salt is precipitated by pouring into cold water—the free base (nitroguanidine) is then liberated by treating the sulfate with sodium carbonate. The freebase is slowly decomposed in alkali solutions. Nitroguanidine is used primarily in the perpetration of other explosives, but it can be used in explosive compositions when alloyed with TNT, RDX, HMX, or other secondary explosives. Nitroguanidine requires a significant detonator or booster for initiation. Nitroguanidine is also widely used in rocket propellants, and gun propellants.

Molecular weight: 104.069	Flammability: Burns with smoky flame, but may flash on ignition
Detonating velocity: Uncalculated	Toxicity: Moderate

Sensitivity: Very low	Classification: Secondary explosive
Stability: Very good	Overall value (as secondary explosive): High

Procedure 22-03A: Preparation of Nitroguanidine

Materials:	1. 120 grams of guanidine
	2. 900 grams of 98% sulfuric acid
	3. 184 grams of 70% nitric acid

Summary: Nitroguanidine is made by adding guanidine to 98% sulfuric acid at 0 Celsius. Afterwards, 70% nitric acid is slowly added to the 98% sulfuric acid mixture, and the addition of the nitric acid oxidizes the guanidine to nitroguanidine. The nitroguanidine remains dissolved in the sulfuric acid, so after the addition of the nitric acid the reaction mixture is poured into cold water. The nitroguanidine then precipitates, and is collected by filtration, washed with cold water, and then dried. Commercial & Industrial note: Part or parts of this laboratory process may be protected by international, and/or commercial/industrial processes. Before using this process to legally manufacture the mentioned explosive, with intent to sell, consult any protected commercial or industrial processes related to, similar to, or additional to, the process discussed in this procedure. This process may be used to legally prepare the mentioned explosive for laboratory, educational, or research purposes.

Hazards: Wear gloves when handling 98% sulfuric acid and 70% nitric acid, which can both cause skin burns and tissue irritation.

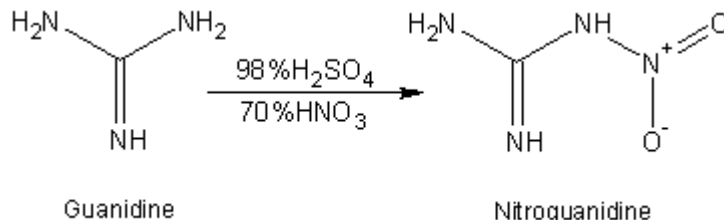

Reaction Equation

Procedure: Place 900 grams of 98% sulfuric acid into a flask, and cool to 0 Celsius by means of an ice bath. When the temperature reaches 0 Celsius, slowly add 120 grams of guanidine in small portions while keeping the 98% sulfuric acid cooled to 0 Celsius and stirring. After the addition of the guanidine, slowly add drop wise, 184 grams of 70% nitric over a period of 1 hour while keeping the reaction mixtures temperature at 0 Celsius and stirring. After addition of the 70% nitric acid, pour the entire reaction mixture onto 1 kilogram of ice, which is contained in a large beaker. After the ice has melted, filter-off the precipitated product, and then wash with 1000 milliliters of cold water. Then vacuum dry, air dry, or dry the product in an oven at 80 Celsius for about 1 hour, or until dry.

Notes:

22-04. NU. Nitrourea

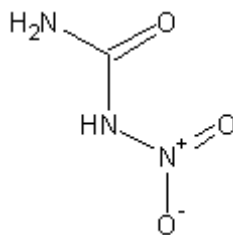

NU

Nitrourea forms colorless to whitish plate like crystals that begin to decompose when heated to 158 Celsius. The crystals are soluble in alcohol, acetic acid, and acetone—they are insoluble in cold water. The nitrate and perchlorate salts of nitrourea are prepared by treating nitrourea with the corresponding acids—the nitrate and perchlorate salts are used in fireworks, and a variety of pyrotechnic compositions. Nitrourea has limited use in explosives due to its lack of explosives power, but it can be used in rocket propellants and gunpowders. Nitrourea is also commonly used in making other explosives. It requires a significant detonator or booster for initiation.

Molecular weight: 105.053	Flammability: Burns with smoky flame, but may flash on ignition
Detonating velocity: Uncalculated	Toxicity: Low
Sensitivity: Very low	Classification: Secondary explosive
Stability: Very good	Overall value (as secondary explosive): Moderate

Procedure 22-04A: Preparation of NU

Materials:	1. 854 grams 98% sulfuric acid
	2. 120 grams urea
	3. 202 grams 70% nitric acid

Summary: Nitrourea is prepared by reacting urea with concentrated sulfuric acid at 0 Celsius, followed by treatment with 70% nitric acid. Thereafter, the reaction mixture is treated with ice, and the product collected by filtration.

Hazards: Wear gloves when handling 70% nitric acid, and 98% sulfuric acid. 98% sulfuric can cause severe burns along with 70% nitric acid.

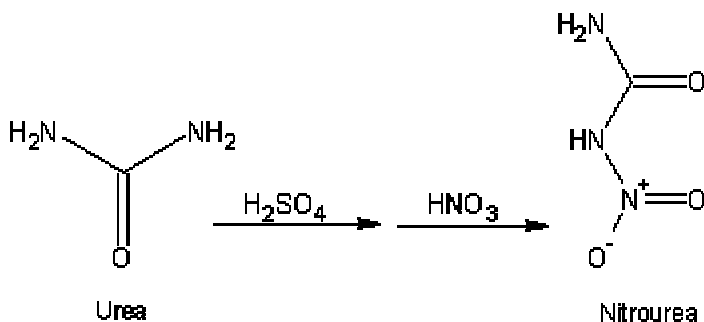

Reaction Equation

Procedure: Place 854 grams of 98% sulfuric acid into a flask, and cool to 0 Celsius by means of an ice bath. Then slowly add 120 grams of urea in small portions while stirring the 98% sulfuric acid and maintaining its temperature at 0 Celsius. After the addition of the urea, slowly add drop wise, 202 grams of 70% nitric over a period of 1 hour while keeping the reaction temperature at 0 Celsius and stirring. After addition of the 70% nitric acid, swirl the flask while pouring the reaction mixture onto 1000 grams of ice. After the ice has melted, collect the nitrourea by filtration. Then wash with 1000 milliliters of cold water, and then dry in an oven at 80 Celsius for about 1 hour, or until dry.

Notes:

22-05. Acetone-P; Acetone peroxide; 3,3,6,6,9,9-hexamethyl-1,2,4,5,7,8-hexoxonane

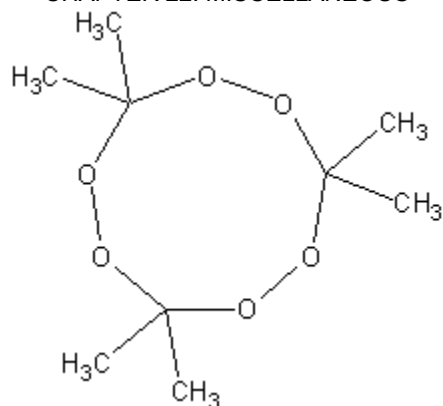

Acetone-P

Acetone-P is an unstable, white powder or crystalline mass with a melting point of 90 to 93 Celsius. The solid is insoluble in water, but soluble in ether and tetrahydrofuran. It is quite unstable and is rarely used in military or commercial explosives. However it can be utilized as a primary explosive in blasting caps or detonators when desensitized with appropriate materials. To do so, it should be mixed with gum Arabic, carbon black, trisodium phosphate, chalk, or silicon dioxide powder, and then mixed with a small amount of paraffin's or saturated oils prior to use. Acetone-P can also be slurried with 10% water and 5% hexane for use in blasting caps or detonators. Pure acetone-P should not be used by itself, as it will decay over time potentially leading to explosions. Acetone-P is rather volatile, and a small sample left out in the open will completely evaporate after several days—partly due to decomposition. Acetone-P can also be used in initiating compositions when mixed with sulfur nitride or other primary explosives, and then added to a small amount of a saturated oil. The sulfur nitride and other primary explosives can be replaced by barium chromate, copper perchlorate, or lead chromate. Even when acetone-P has been successfully desensitized, it should be used within 2 weeks of preparation.

Molecular weight: 222.236	Flammability: Detonates when ignited
Detonating velocity: 5250 (calculated)	Toxicity: Low
Sensitivity: High	Classification: Primary explosive
Stability: Low	Overall value (as primary explosive): Low

Procedure 22-05A: Preparation of Acetone-P

Materials:	1. 115 milliliters of acetone
	2. 10 grams of 98% sulfuric acid
	3. 70 milliliters of 30% hydrogen peroxide
	4. 500 milliliters of diethyl ether

Summary: Acetone-P can be prepared in a rather simple manner by adding concentrated hydrogen peroxide to an acetone solution in the presence of sulfuric acid. The product later precipitates, is collected by filtration, washed, and then dried in a desiccator.

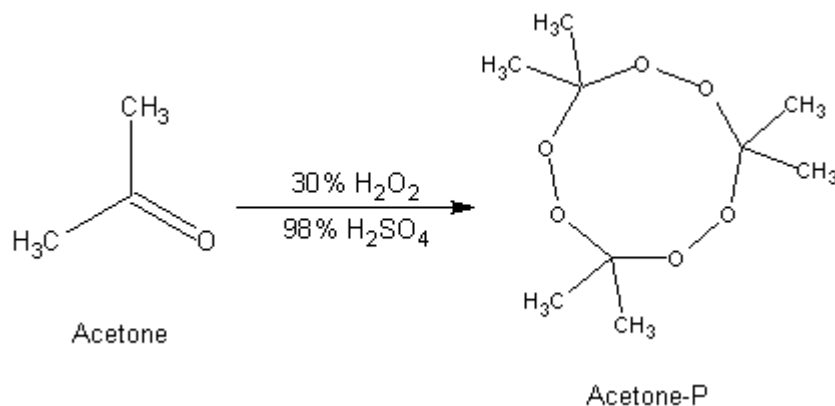

Reaction Equation

Hazards: Use care when handling 30% hydrogen peroxide. Keep it away from alcohol, ethers, and acetates to avoid formation of dangerous peroxides. Use the standard warnings when using concentrated sulfuric acid. Acetone is flammable so avoid contact with flames, sparks, and other sources of ignition.

Procedure: Into a suitable 3-neck flask equipped with a motorized stirrer, thermometer, and addition funnel, place 230 milliliters of a 50% (by volume) acetone solution (prepared by mixing 115 milliliters of acetone with 115 milliliters of distilled water), followed by 10 grams of 98% sulfuric acid, and then place this 3-neck flask into an ice bath and chill to 0 Celsius. When its temperature reaches 0 Celsius, place 70 milliliters of 30% hydrogen peroxide into the addition funnel, and then begin adding the 30% hydrogen peroxide to the acetone solution drop-by-drop over a period of about 1 hour while moderately stirring the acetone solution—during the hydrogen peroxide addition, keep the temperature of the acetone mixture below 5 Celsius at all times. After the addition of the 30% hydrogen peroxide, continue to stir the reaction mixture for 2 hours at 0 Celsius. Afterwards, remove the ice bath, and allow the reaction mixture to warm to room temperature; thereafter, stop the stirring and allow the reaction mixture to stand at room temperature for 24 hours. After 24 hours, filter-off the white precipitated product, wash with 150 milliliters of cold water (3 times using the same washing portion), and then place the white solid product into a desiccator filled with anhydrous sodium sulfate, and allow it fully dry. The dry solid should then be immediately desensitized using the materials described earlier. Note: The dry solid can be recrystallized from 500 milliliters of diethyl ether if desired, but this is not generally needed.

Notes:

22-06. Tetracene. Tetrazene; (2E)-3-[imino(3-oxotriazanyl)methyl]triaz-2-ene-1-carboximidamide

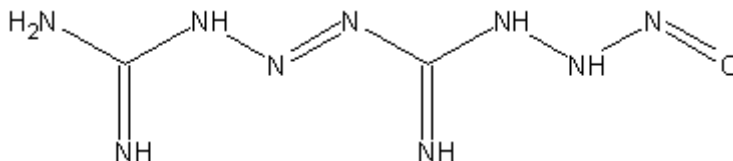

Tetracene

Tetracene forms pale yellow to lightly yellowish crystals, powder, or fluffy flakes which begin to decompose when heated to 150+ Celsius. The crystals may explode if rapidly heated to 161 Celsius producing a flash of mild light and a smoky bang with the evolution of ammonia. Tetracene is decomposed by hot water and alkalis, and should be stored dry in amber glass bottles, and in a cool place away from light. Tetracene is used heavily in the formation of initiating charges and booster charges in combination with lead azide, diazodinitrophenol, lead styphnate, and other common primary explosives. Tetracene has been replaced by many other primary explosives such as sulfur nitride, and salts of triazoles and tetrazoles for use in blasting caps and detonators. However it can still be used in blasting caps and detonators with satisfactory results when compressed using hydraulic presses—tetracene should be packed into blasting caps and detonators under high pressure.

Molecular weight: 173.137	Flammability: Flashes when ignited
Detonating velocity: Similar to the fulminates	Toxicity: Low
Sensitivity: Low	Classification: Primary explosive
Stability: Good	Overall value (as primary explosive): High

Procedure 22-06A: Preparation of Tetracene

Materials:	1. 30 grams of aminoguanidine hydrochloride
	2. 20 milliliters of glacial acetic acid
	3. 5 milliliters of acetic anhydride
	4. 30 grams of sodium nitrite

Summary: Tetracene is readily prepared by the diazonium reaction involving sodium nitrite. To carryout this reaction, aminoguanidine hydrochloride is treated with glacial acetic acid in the presence of acetic anhydride, and the resulting mixture

is then gently heated, and then mixed with sodium nitrite. The resulting mixture is then drowned into cold water, allowed to stand for 24 hours, and then the insoluble product is collected by filtration, washed, and then dried.

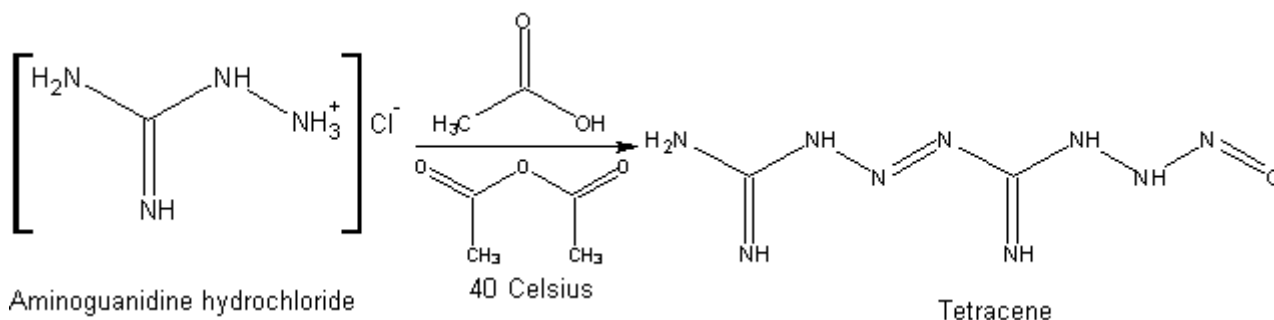

Reaction Equation

Hazards: Use care when handling glacial acetic acid, and acetic anhydride, both of which are corrosive.

Procedure: Into a suitable flask, equipped with a thermometer, motorized stirrer and powder funnel, add 30 grams of aminoguanidine hydrochloride, followed by 20 milliliters of glacial acetic acid, followed by 5 milliliters of acetic anhydride. Thereafter, gently heat this mixture to 40 Celsius, and stir for 1 hour. Then slowly add, in small portions, 30 grams of sodium nitrite while stirring the reaction mixture and maintaining its temperature at 40 Celsius. After the addition of the sodium nitrite, continue to stir the reaction mixture at 40 Celsius for 1 hour. Afterwards, remove the heat source, and allow the reaction mixture to cool to room temperature. Then drown the entire reaction mixture into 500 milliliters of ice-cold water, and then stir the entire mixture for 24 hours at room temperature. After 24 hours, filter-off the insoluble crystals, and then wash them with three 250 milliliter portions of cold water. Thereafter, vacuum dry or air-dry the crystals, and then place the crystals into a desiccator and dry for 48 hours. Thereafter, place the crystals into a amber glass bottle and store in a cool place until use.

Notes:

References

- Kawabe , et al. October 2, 2001
Kawabe; Shuji (Oita, JP); Miya; Hiroshi (Oita, JP); Kodama; Tamotsu (Kurashiki, JP); Miyake; Nobuhisa (Kurashiki, JP)
Asahi Kasei Kabushiki Kaisha (JP)
Lukasavage , et al. April 10, 2001
Lukasavage; William J. (Pearland, TX); Behrmann; Lawrence A. (Houston, TX); Voreck; Wallace E. (Sparta, NJ)
Schlumberger Technology Corporation (Sugar Land, TX)
Duddu , et al. December 12, 2000
Duddu; Raja (Budd Lake, NJ); Dave; Paritosh R. (Bridgewater, NJ)
The United States of America as represented by the Secretary of the Army (Washington, DC)
Hyoda; Shunji (Sakaide, JP); Kita; Masaharu (Sakaide, JP); Sawada; Hirotohi (Sakaide, JP); Nemugaki; Shuichi (Sakaide, JP); Ueta; Takahiro (Sakaide, JP); Satoh; Kohki (Sakaide, JP); Otsuka; Sumio (Takamatsu, JP); Miyawaki; Yoshitaka (Takamatsu, JP); Taniguchi; Hiroshi (Takamatsu, JP)
Japan Hydrazine Co., Inc. (Tokyo, JP); Masuda Chemical Industry Co., LTD. (Tokyo, JP)
Wardle; Robert B. (Logan, UT); Hajik; Robert M. (Willard, UT); Hinshaw; Jerald C. (Ogden, UT); Highsmith; Thomas K. (Ogden, UT)
Cordant Technologies Inc. (Salt Lake City, UT)
Comfort May 23, 2000
Comfort; Theodore F. (Cumberland, MD)
Alliant Techsystems Inc. (Hopkins, MN)
Aubert , et al. December 7, 1999
Aubert; Stephen A. (Niceville, FL); McKenney, Jr.; Robert L. (Niceville, FL); Reich; Richard F. (Ft. Walton Beach, FL); Sprague; Charles T. (Niceville, FL)
The United States of America as represented by the Secretary of the Air (Washington, DC)
Langlet , et al. November 2, 1999
Langlet; Abraham (Stockholm, SE); Ostmark; Henric (Huddinge, SE); Wingborg; Niklas (Stockholm, SE) Forsvarets Forskningsanstalt (Stockholm, SE)
Stec, III; Daniel (Hackettstown, NJ); Perez; Ralph L. (Ogdensburg, NJ); Dave; Paritosh R. (Bridgewater, NJ); Archibald; Thomas G. (Fair Oaks, CA)
The United States of America as represented by the The Secretary of the (Washington, DC)
Suzuki; Shigeru (Saitama-ken, JP); Miyazaki; Shigefumi (Saitama-ken, JP); Hatano; Hideo (Akigawa, JP); Shiino; Kazuo (Akigawa, JP); Onda; Toshio (Akigawa, JP)
Nissan Motor Co., Ltd. (Kanagawa, JP); Hosoya Fireworks Co., Ltd. (Tokyo, JP)
Suzuki , et al. August 19, 1997
Suzuki; Shigeru (Saitama-ken, JP); Miyazaki; Shigefumi (Saitama-ken, JP); Hatano; Hideo (Akigawa, JP); Shiino; Kazuo (Akigawa, JP); Onda; Toshio (Akigawa, JP)
Nissan Motor Co., Ltd. (Kanagawa, JP); Hosoya Fireworks Co., Ltd. (Tokyo, JP)
Erickson , et al. March 11, 1997
Erickson; Jack A. (Andover, MN); Melberg; John M. (Andover, MN); Kramer; Robert L. (Minneapolis, MN); Hallis; John M. (Buffalo, MN)
Federal-Hoffman, Inc. (Anoka, MN)
Wallace E. Voreck Jr., Sparta, NJ; James E. Brooks, Manvel, TX; John R. Eberhardt, Hooshang A. Rezaie, Houston, TX
Schlumberger, Houston, TX5,
Rindone , et al. July 2, 1996
Rindone; Renato R. (Fair Oaks, CA); Huang; Der-Shing (Carmichael, CA); Hamel; Edward E. (Roseville, CA)
Aerojet General Corporation (Sacramento, CA)
Zabala , et al. April 16, 1996
Zabala; Juan A. A. (Bilbao, ES); De Segura; Fernando B. G. (Vitoria, ES); Ocejo; Agustin G. (Bilbao, ES); Zimmermann; Leon M. (Johannesburg, ZA); Hall; Marie V. M. (Johannesburg, ZA)
Union Espanola de Explosivos, Sociedad Anonima (Madrid, ES)
- Highsmith; Thomas K. (North Ogden, UT); Edwards; W. Wayne (Tremonton, UT); Wardle; Robert B. (Logan, UT)
Thiokol Corporation (Ogden, UT)
Chaykovsky , et al. April 25, 1995
Chaykovsky; Michael (Columbia, MD); Adolph; Horst G. (Silver Spring, MD)
The United States of America as represented by the Secretary of the Navy (Washington, DC)
Hunag; Der-Shing (Folsom, CA)
Gencorp Aerojet (Rancho Cordova, CA)
Chaykovsky; Michael (Columbia, MD); Koppes; William M. (Adelphi, MD)
The United States of America as represented by the Secretary of the Navy (Washington, DC)

Lukasavage , et al. October 5, 1993
 Lukasavage; William J. (Las Vegas, NV); Nicolich; Steven (Saddle Brook, NJ); Slagg; Norman (Wayne, NJ)
 The United States of America as represented by the Secretary of the Army (Washington, DC)
 Bottaro , et al. March 30, 1993
 Bottaro; Jeffrey C. (Mountain View, CA); Schmitt; Robert J. (Redwood City, CA); Penwell; Paul E. (Menlo Park, CA); Ross; David S. (Palo Alto, CA)
 SRI International (Menlo Park, CA)
 Lukasavage , et al. June 9, 1992
 Lukasavage; William (Succasunna, NJ); Nicolich; Steven (Saddlebrook, NJ); Alster; Jack (Fair Lawn, NJ)
 The United States of America as represented by the Secretary of the Army (Washington, DC)
 Olsen; Robert E. (Placerville, CA); Homer; George D. (Orangevale, CA); Barnard; James C. (Shingle Springs, CA)
 Aerojet-General Corporation (Folsom, CA)
 Golding , et al. June 11, 1991
 Golding; Peter (Kings Langley, GB); Jayaweera-Bandara; Asoka M. (Long Ditton, GB); Duffin; Henry (Surbiton, GB)
 The Secretary of State for Defence in her Britannic Majesty's Government (London, GB)
 Ott , et al. March 5, 1991
 Ott; Donald G. (Los Alamos, NM); Benziger; Theodore M. (Santa Fe, NM)
 The United States of America as represented by the United States (Washington, DC)
 Huang , et al. January 8, 1991
 Huang; Der-Shing (Carmichael, CA); Rindone; Renato R. (Fair Oaks, CA)
 Aerojet General Corporation (Folsom, CA)
 Laval , et al. September 18, 1990
 Laval; Francois (Monts, FR); Vignane; Pascal (Tours, FR)
 Commissariat a l'Energie Atomique (Paris, FR)
 Ott , et al. August 28, 1990
 Ott; Donald G. (Los Alamos, NM); Benziger; Theodore M. (Santa Fe, NM)
 The United States of America as represented by the United States (Washington, DC)
 Huang , et al. June 26, 1990
 Huang; Der-Shing (Carmichael, CA); Rindone; Renato R. (Fair Oaks, CA)
 Aerojet-General Corporation (Folsom, CA)
 Frankel , et al. February 13, 1990
 Frankel; Milton B. (Tarzana, CA); Weber; James F. (Moorpark, CA)
 The United States of America as represented by the Secretary of the Air (Washington, DC)
 Riggs August 29, 1989
 Riggs; Robert S. (Grand Prairie, TX)
 Jet Research Center, Inc. (Arlington, TX)
 Hillstrom August 29, 1989
 Hillstrom; Warren W. (Bel Air, MD)
 The United States of America as represented by the Secretary of the Army (Washington, DC)
 Cunningham , et al. June 6, 1989
 Cunningham; Glenn R. (Upper St. Clair, PA); Senules; Alex (Pittsburgh, PA)
 Mitchell Chemical Co. (Upper St. Clair, PA)
 O'Keefe May 23, 1989
 O'Keefe; David M. (Mansfield, TX)
 Texas Explosives Co Inc (Mansfield, TX)
 Frankel , et al. January 3, 1989
 Frankel; Milton B. (Tarzana, CA); Weber; James F. (Moorpark, CA)
 The United States of America as represented by the Secretary of the Air (Washington, DC)
 Frankel , et al. August 2, 1988
 Frankel; Milton B. (Tarzana, CA); Witucki; Edward F. (Van Nuys, CA)
 Rockwell International Corporation (El Segundo, CA)
 O'Keefe June 14, 1988
 O'Keefe; David M. (Mansfield, TX)
 Texas Explosives Co. Inc. (Mansfield, TX)
 Schmitt , et al. May 17, 1988
 Schmitt; Robert J. (Mountain View, CA); Ross; David S. (Palo Alto, CA); Wolfe; James F. (Palo Alto, CA)
 SRI International (Menlo Park, CA)
 April, 27th 1987
 Horst G. Adolph, Silver Spring, Kyung E. Kim, Potomac Md
 The United Sates Navy
 Lee , et al. March 29, 1988
 Lee; Kien-Yin (Los Alamos, NM); Coburn; Michael D. (Los Alamos, NM)

The United States of America as represented by the United States (Washington, DC)
Aubert November 10, 1987
Aubert; Stephen A. (300 Greenwood Cove North, Niceville, FL 32578)
Back , et al. October 13, 1987
Back; Sigurd (Karlskoga, SE); Nyqvist; Jan-Olof (Karlskoga, SE); Ericsson; Per (Karlskoga, SE)
Nobel Kemi AB (Karlskoga, SE)
Duffin , et al. December 2, 1986
Duffin; Henry C. (Surbiton, GB2); Golding; Peter (Epping, GB2); Jaweera-Bandara; Asoka M.
(Surbiton, GB2)
The Secretary of State for Defence in Her Britannic Majesty's Government (London, GB2)
Duguet January 28, 1986
Duguet; Jean (Tarbes, FR)
L'Etat Francais represente par le Delege Ministeriel pour L'Armement
Lee September 3, 1985
Lee; Kien-yin (Los Alamos, NM)
The United States of America as represented by the United States (Washington, DC)
Willer September 3, 1985
Willer; Rodney L. (Ridgecrest, CA)
The United States of America as represented by the Secretary of the Navy (Washington, DC)
Sollott , et al. August 13, 1985
Sollott; Gilbert P. (Plymouth Meeting, PA); Gilbert; Everett E. (Morristown, NJ)
The United States of America as represented by the Secretary of the Army (Washington, DC)
Wagner, III , et al. August 6, 1985
Wagner, III; Frederick B. (R.D. #2, Margarete Dr., Box 679, Elmer, NJ 08318); Izbicki; Anthony J.
(Reading, PA)
Wagner, III; Frederick B. (Elmer, NJ)
Udy , et al. July 9, 1985
Udy; Lex L. (4597 Ledgemont Dr., Holladay, UT 84117); Day; John T. (5 Dawn Hill, Sandy, UT
84070)
Naufflett April 23, 1985
Naufflett; George W. (Oxon Hill, MD)
The United States of America as represented by the Secretary of the Navy (Washington, DC)
July 26th 1982
Milton B. Frankel, Tarazana, Edgar R. Wilson, Simi Valley, California
Rockwell International Corporation, El Segundo, CA
Rothgery November 13, 1984
Rothgery; Eugene F. (North Branford, CT)
Olin Corporation (Cheshire, CT)
Wright November 13, 1984
Wright; Sam B. (Holston Ordnance, Kingsport, TN 37660)
Chang , et al. October 9, 1984
Chang; Marguerite S. (Fort Washington, MD); Orndoff; Robert R. (Waldorf, MD)
The United States of America as represented by the Secretary of the Navy (Washington, DC)
Maes , et al. June 26, 1984
Maes; Michel E. (King County, WA); Shaw; Robert L. (Dallas County, TX); Reinsch; Royal L.
(King County, WA)
Energy Sciences Partners, Ltd. (Seattle, WA)
Atkins , et al. May 29, 1984
Atkins; Ronald L. (Ridgecrest, CA); Hollins; Richard A. (Ridgecrest, CA); Norris; William P.
(Ridgecrest, CA); Nielsen; Arnold T. (Ridgecrest, CA); Wilson; William S. (Greensborough, AU)
The United States of America as represented by the Secretary of the Navy (Washington, DC)
Simmons , et al. May 22, 1984
Simmons; Ronald L. (Destin, FL); Young; Herbert L. (Shalimar, FL)
Hercules Incorporated (Wilmington, DE)
Stanton , et al. May 1, 1984
Stanton; Horace D. (Ridgecrest, CA); Reed, Jr.; Russell (Ridgecrest, CA)
The United States of America as represented by the Secretary of the Navy (Washington, DC)
Willer April 17, 1984
Willer; Rodney L. (Ridgecrest, CA)
The United States of America as represented by the Secretary of the Navy (Washington, DC)
DeFusco, Jr. , et al. February 28, 1984
DeFusco, Jr.; Albert A. (Ridgecrest, CA); Nielsen; Arnold T. (Ridgecrest, CA); Atkins; Ronald L.
(Ridgecrest, CA)
The United States of America as represented by the Secretary of the Navy (Washington, DC)
Painter February 7, 1984
Painter; Alfred E. (Bridgewater, GB2)
The Secretary of State for Defence in Her Britannic Majesty's Government (London, GB2)

Atkins , et al. January 17, 1984
 Atkins; Ronald L. (Ridgecrest, CA); Norris; William P. (Ridgecrest, CA); Nielsen; Arnold T. (Ridgecrest, CA); Hollins; Richard A. (Ridgecrest, CA); Wilson; William S. (Ridgecrest, CA)
 The United States of America as represented by the Secretary of the Navy (Washington, DC)

Jones January 10, 1984
 Jones; Walter T. (Orpington, GB2)
 The Secretary of State for Defence in Her Britannic Majesty's Government (London, GB2)

Hasegawa , et al. November 1, 1983
 Hasegawa; Kunio (Aichi, JP); Takizuka; Michinori (Handa, JP)
 Nippon Oil and Fats Co., Ltd. (Tokyo, JP)

Deisenroth September 20, 1983
 Deisenroth; Friedrich-Ulf (Fichtenweg 1, 8899 Rettenbach, DE)

Kabik , et al. July 19, 1983
 Kabik; Irving (Silver Spring, MD); Ringbloom; Vernon D. (West Friendship, MD)
 The United States of America as represented by the Secretary of the Navy (Washington, DC)

Breza, deceased , et al. August 10, 1982
 Breza, deceased; Cyril J. (late of Hagerstown, MD); Schaefer; William E. (Hagerstown, MD)
 E. I. Du Pont de Nemours and Company (Wilmington, DE)

Oct. 10th 1980
 Gail W. Lawrence, Horst G. Adolph both of Silver springs MD
 United States of America

Strecker July 6, 1982
 Strecker; Richard A. (Randolph, NJ)
 The United States of America as represented by the Secretary of the Army (Washington, DC)

Gilbert , et al. May 11, 1982
 Gilbert; Everett E. (Morristown, NJ); Sollott; Gilbert P. (Plymouth Meeting, PA)
 The United States of America as represented by the Secretary of the Army (Washington, DC)

John J. Frost, Kraainem, Belgium
 Oregon, Etablissement fur Patentverwertung, Austria

Voigt, Jr. , et al. April 20, 1982
 Voigt, Jr.; H. William (Wharton, NJ); Banker; Bernard R. (Mine Hill, NJ)
 The United States of America as represented by the Secretary of the Army (Washington, DC)

Godsey November 3, 1981
 Godsey; James H. (Cumberland, MD)
 Hercules Incorporated (Wilmington, DE)

Edwards , et al. April 21, 1981
 Edwards; Donald W. (Provo, UT); Zukovich; Thomas M. (Palatine, IL); Thomas; Ronald D. (Spanish Fork, UT); Weigel; Ronald M. (Salt Lake City, UT)
 International Minerals & Chemical Corp. (Terre Haute, IN)

Gilbert January 27, 1981
 Gilbert; Everett E. (Morristown, NJ)
 The United States of America as represented by the Secretary of the Army (Washington, DC)

Gilbert January 13, 1981
 Gilbert; Everett E. (Morristown, NJ)
 The United States of America as represented by the Secretary of the Army (Washington, DC)

Inoue , et al. July 29, 1980
 Inoue; Kazuhiro (Aichi, JP); Matsui; Fumio (Handa, JP)
 Nippon Oil and Fats Co., Ltd. (Tokyo, JP)

Koppes , et al. November 6, 1979
 Koppes; William M. (Adelphi, MD); Adolph; Horst G. (Silver Spring, MD); Sitzmann; Michael E. (Adelphi, MD)
 The United States of America as represented by the Secretary of the Navy (Washington, DC)

Benziger September 18, 1979
 Benziger; Theodore M. (Santa Fe, NM)
 The United States of America as represented by the United States (Washington, DC)

Rothenstein , et al. August 7, 1979
 Rothenstein; Julius (Citrus Heights, CA); Goldhagen; Samuel (Sacramento, CA)
 The United States of America as represented by the Secretary of the Navy (Washington, DC)

Barnett January 16, 1979
 Barnett; George H. (North Balwyn, AU)
 ICI Australia Limited (Victoria, AU)

Frankel , et al. October 24, 1978
 Frankel; Milton B. (Tarzana, CA); Gunderloy, Jr.; Frank C. (Santa Susana, CA); Woolery, II; Dean O. (Reseda, CA)
 Rockwell International Corporation (El Segundo, CA)

Helfgen , et al. September 12, 1978
 Helfgen; Werner (Troisdorf, DE); Lindner; Gerhard (Leverkusen, DE); Lingens; Paul (Odenthal-

Globusch, DE); Kaufmann; Helmut (Troisdorf, DE)
 Dynamit Nobel Aktiengesellschaft (DE)
 Gilligan , et al. June 6, 1978
 Gilligan; William H. (Washington, DC); Kamlet; Mortimer J. (Silver Spring, MD)
 The United States of America as represented by the Secretary of the Navy (Washington, DC)
 Flanagan , et al. April 18, 1978
 Flanagan; Joseph E. (Woodland Hills, CA); Frankel; Milton B. (Tarzana, CA)
 Rockwell International Corporation (El Segundo, CA)
 Coon September 21, 1976
 Coon; Clifford L. (Menlo Park, CA)
 Koppers Company, Inc. (Pittsburgh, PA)
 Dunlop , et al. May 4, 1976
 Dunlop; James Littlejohn (Kilmarnock, SC); Stevely; Robert Reid (Saltcoats, SC)
 Imperial Chemical Industries Limited (London, EN)
 Shipp , et al. March 2, 1976
 Shipp; Kathryn G. (Silver Spring, MD); Kaplan; Lloyd A. (Silver Spring, MD)
 The United States of America as represented by the Secretary of the Navy (Washington, DC)
 Meredith; Joseph A. (Bluff City, TN)
 The United States of America as represented by the Secretary of the Army (Washington, DC)
 Sept. 18th 1967
 Jonas Zucker, West Orange, Russel Trask, Morris Plains, both of NJ, Edward Costa, Brooklyn, NY
 Dec. 12th 1972
 Russell E. Lerman, Morris, NJ
 The united states Army
 Feb 12th 1969
 Chales T. Rittenhouse, Glendale, AZ
 Unldynamics/Phenoix Goodyear, Ariz.
 May 1st 1969
 Philip Barnhard, IV, West Chester, Pa.
 EI Du Pont De Nemours, Wilmington, Del.
 April 17th 1964
 Harold F. Bluhm Tamaqua, Pa.
 Atlas Chemical Industries, Inc.
 March 8th 1957
 Henry A. Rolewicz, Charles D. Grimes, Jr., Kenyon Stevenson, Jr., Huntsville Alabama Rhom Haas
 Company, Philadelphia PA
 August 3rd 1960
 John R. Lovett, Edison, NJ;
 Esso Research and Engineering Company
 Bjorm Herman, Olof Simmons, Karlskoga, Sweeden;
 Aktebolaget Bofors, Bofors Sweeden
 Oct. 3, 1967
 Clayton J. Schneider, Jr. Amherst, NY
 Cornell Aeronautical Laboratory, Inc. Buffalo, NY
 Feb. 20th 1963
 Donald N. Thatcher Pitman NJ
 EI Dupont De Nemours Willmington Del.
 May 3rd 1957
 Newton Rosser Smith and Richard Haven Wiley, Lousiville KY.
 Mesne assignments United States Navy
 Donald J. Glover, Bowie Md; Joseph C. Dacons, and Darrell V. Sickman, Washington DC, and
 Marios E. Hill Kensington, and Mortimer J. Kamlet, Silver Spring Md.
 The United States Navy
 Richard H. Wiley and Newton R. Smith, Louisville Ky
 Mesne assignments United States Navy
 Sept. 24th 1958
 Chrales E. Inman, Glenside Pa; Robert E. Oesterling, Silver spring Md; Edward E. Tyczkowski,
 Willow Grove Pa
 Pennsalt chemical corporation Philadelphia Pa
 June 19th 1956
 Howard G. Clark, Decatur Alabama; Charles W. Plummer, Rockland Mass.; Sandor A. Hoffmann,
 Bayonne, NJ
 United States of America
 February 27th 1953
 Pliny O. Tawney, Passaic, NJ,
 United States Rubber Company, New York, NY
 May 13th 1959

Lloyd A. Kaplan, Adelphi, and Francis Taylor, Jr., Baltimore Md.
The United States Navy
April 14th 1959

Christoph J. Grundmann, Lancaster Pa, and Wilhelm Joseph Schnabel, Columbus Ohio
Olin Mathieson Chemical Corporation, Virginia
Nov 15th 1957

Jean P. Picard Morristown NJ
United States of America
Feb 2nd 1959

Henry Feuer, Lafayette, Ind., and William A. Swarts, Chicago, ILL.
Purdue Research Foundation, Lafayette Ind.
January 20th 1959

John C. Krantz, Jr., Ruxton, and Raymond M. Burgison Catonsville MD
The Chattanooga Tenn.
July 10th 1958

Louis B. Silverman Kenil NJ
United States of America
Aug. 2nd 1957

Ignance A. Grageroff, New York, NY
Vsevoid A. Amoretty, New York, NY
Charles Sauer, Cambridge, Mass;
Arthur D. Little, Inc. Cambridge, Mass
Aug. 27, 1951

George P. Sillito, West Kilbride, and Alexander Butchart, Ardrossan, Scotland
Imperila Chemical Company, UK
February 13th 1946

John A. Hannum, and Morris Frumin, Detroit Michigan
Mesne assignments Borg-warner Corporation, Chicago IL.
July, 8th 1947

Leon Rubenstein, Saltcoats, Scotland
Imperial Chemical Industries Limited, UK
Dec. 30th 1944

Alfred T. Blomquist, and Fred T. Fiedorek, Ithaca, NY
The United States Navy
Dec. 30th 1944

Alfred T. Blomquist, and Fred T. Fiedorek, Ithaca, NY
The United States Navy
Dec. 30th 1944

George F. Wright, Toronto, Ontario, Walter John Chute, Kentville, Nova Scotia, Canada
Advisory Council for Scientific and Industrial Research, Ottawa Ontario Canada
Dec. 30th 1944

George F. Wright, Toronto, Ontario, Walter John Chute, Kentville, Nova Scotia, Canada
Advisory Council for Scientific and Industrial Research, Ottawa Ontario Canada
December 30th 1941

William Frederick Filbert, Woodbury NJ
EI Du Pont Nemours Company Wilmington Del.
John D. Brandner, West Walker Township, Pa
Atlas Powder Company, Wilmington, Del.
Sept. 23rd 1939

Delbert R. Jones, East Alton and Carl J. Roberts, Wood River IL.
Western Cartridge Company
April 29th 1940

Joseph A. Wyler, Allentown, PA
Trojan Powder Company
Nov. 28th 1940

Willi Brun, Bridgeport, Con.
Remington Arms Company, Delaware
Oct. 30th 1939

William B. Woodring, Alton, ILL.
Western Cartridge Company, East Alton ILL.
Feb. 23rd 1938

Joseph Simon, Chicago, ILL.
Daniel Hewitt, Chicago, ILL.
Decemebr 21, 1937

Leon W. Babcock, Kenil, NJ
Hercules Powder Company, Willmington, Del.
Feb. 8th 1935

Mahlon G. Milliken, Wilmington, Del.
 Hercules Powder Company, Wilmington, Del.
 Edmund von Herz, Colonge-Dellbruck, Germany
 March 2nd, 1935
 Roderick K. Eskew, Portland Maine, Mesne assignments
 EI Du Pont Nemours, Wilmington, Del.
 Jan. 29th 1936
 Joseph A. Wyler, Allentown Pa.
 Trojan Powder Company, New York
 May 18th 1933
 Clarence W. Brooke, Jr., Woodbury NJ
 EI Du Pont De Nemours, Wilmington, Del.
 Sept 16th 1929
 David E. Wiggam, Kenvile, NJ;
 Hercules Powder Company, Wilmington, Del.
 August 30th 1930
 Charles E. Burke and Russell McGill, Willmington Del.
 EI Dupont De Nemours & Compnay Willmington Del.
 June 25th 1930
 Ernest Tschudin, Reinach, near Basel Switzerland
 August 8th 1930
 Willard Crater, Succansunna, New Jersey
 Hercules Powder Company, Willmington, Del.
 October 6th 1928
 Frank H. Bergeim, Leonia, New Jersey
 EI Du Pont Nemours, Willmington, Del.
 April 15th 1927
 Frank H. Bergeim, Woodbury, New Jersey
 EI Du Pont Nemours, Willmington, Del.
 December 31st 1926
 John Marshall, Swarthmore, Pennsylvania, and Frank H. Bergeim, Woodbury, New Jersey
 EI Du Pont Nemours, Willmington, Del.
 June 18th, 1926
 Frank H. Bergeim, Woodbury, New Jersey
 EI Du Pont Nemours, Willmington, Del.
 George C. Hale, and Fredrich Olsen, Dover, New Jersey
 Dec. 19th 1921
 Walter Friedrich, Treisdorf, near cologne Germany
 December 9th 1919
 William M. Dehn, Seattle, WA
 Aug. 20th 1920
 William M. Dehn, Seattle, Wa
 Harley T. Peck, Lebanon Ohio
 Peters Cartridge Company, Cincinnati, Ohio
 December 6th 1921
 Willard c. Cope, Woodbury, New Jersey
 EI Du Pont Nemours, Wilmington, del.
 Feb. 4th 1911
 Bernhard Jacques, Flurschein, of Fleet, England
 Nov. 30th 1920
 Roy Linden Hill, Tamaqua, Pennsylvania
 Atlas Powder Company, Wilmington, Del.
 June 11th 1912
 Ernest Goodwin, Stamford Hill London, England; Eley Brothers Limited, Edmonton, London,
 England
 March 28th 1904
 Adolph Voigt, Schonbeck-on-the-elbe, Germany
 Dec. 30th 1889
 Paul Butler, Lowell, Mass
 Chaykovsky; Michael (Columbia, MD); Adolph; Horst G. (Silver Spring, MD)
 The United States of America as represented by the Secretary of the Navy (Washington, DC).
 July, 28th 1988
 Michael E. Sitzmann, Aldelphi, Horst G. Adolph, Burtonsville, Md
 Jult 10th 1866
 Georg Boldt, Chicago, ILL.

Hill, Inc. United States of America, 1987

Gershon J. Shugar and Jack T. Ballinger: *Chemical Technicians Ready Reference Handbook*, 4th edition,. McGraw-Hill, Inc. United States of America, 1996

Merck & Co., Inc.: *The Merck Index*, 12th edition,. Whitehouse Station, NJ, 1996

Donald L. Pavia, Gary M. Lampman, and George S. Kriz: *Organic chemistry I*, 1999 revision,. United Sates of America, 1999

Jerry March: *Advanced Organic Chemistry*, 4th edition,. John Wiley & Sons. United States of America, 1992